

KEITHLEY

Model 82-DOS Simultaneous C-V

Instruction Manual

A GREATER MEASURE OF CONFIDENCE

WARRANTY

Keithley Instruments, Inc. warrants this product to be free from defects in material and workmanship for a period of 1 year from date of shipment.

Keithley Instruments, Inc. warrants the following items for 90 days from the date of shipment: probes, cables, rechargeable batteries, diskettes, and documentation.

During the warranty period, we will, at our option, either repair or replace any product that proves to be defective.

To exercise this warranty, write or call your local Keithley representative, or contact Keithley headquarters in Cleveland, Ohio. You will be given prompt assistance and return instructions. Send the product, transportation prepaid, to the indicated service facility. Repairs will be made and the product returned, transportation prepaid. Repaired or replaced products are warranted for the balance of the original warranty period, or at least 90 days.

LIMITATION OF WARRANTY

This warranty does not apply to defects resulting from product modification without Keithley's express written consent, or misuse of any product or part. This warranty also does not apply to fuses, software, non-rechargeable batteries, damage from battery leakage, or problems arising from normal wear or failure to follow instructions.

THIS WARRANTY IS IN LIEU OF ALL OTHER WARRANTIES, EXPRESSED OR IMPLIED, INCLUDING ANY IMPLIED WARRANTY OF MERCHANTABILITY OR FITNESS FOR A PARTICULAR USE. THE REMEDIES PROVIDED HEREIN ARE BUYER'S SOLE AND EXCLUSIVE REMEDIES.

NEITHER KEITHLEY INSTRUMENTS, INC. NOR ANY OF ITS EMPLOYEES SHALL BE LIABLE FOR ANY DIRECT, INDIRECT, SPECIAL, INCIDENTAL OR CONSEQUENTIAL DAMAGES ARISING OUT OF THE USE OF ITS INSTRUMENTS AND SOFTWARE EVEN IF KEITHLEY INSTRUMENTS, INC., HAS BEEN ADVISED IN ADVANCE OF THE POSSIBILITY OF SUCH DAMAGES. SUCH EXCLUDED DAMAGES SHALL INCLUDE, BUT ARE NOT LIMITED TO: COSTS OF REMOVAL AND INSTALLATION, LOSSES SUSTAINED AS THE RESULT OF INJURY TO ANY PERSON, OR DAMAGE TO PROPERTY.



Keithley Instruments, Inc.

28775 Aurora Road • Cleveland, Ohio 44139 • 440-248-0400 • Fax: 440-248-6168
1-888-KEITHLEY (534-8453) • www.keithley.com

Sales Offices:

BELGIUM:	Bergensesteenweg 709 • B-1600 Sint-Pieters-Leeuw • 02-363 00 40 • Fax: 02/363 00 64
CHINA:	Yuan Chen Xin Building, Room 705 • 12 Yumin Road, Dewai, Madian • Beijing 100029 • 8610-8225-1886 • Fax: 8610-8225-1892
FINLAND:	Tietäjantie 2 • 02130 Espoo • Phone: 09-54 75 08 10 • Fax: 09-25 10 51 00
FRANCE:	3, allée des Garays • 91127 Palaiseau Cédex • 01-64 53 20 20 • Fax: 01-60 11 77 26
GERMANY:	Landsberger Strasse 65 • 82110 Germering • 089/84 93 07-40 • Fax: 089/84 93 07-34
GREAT BRITAIN:	Unit 2 Commerce Park, Brunel Road • Theale • Berkshire RG7 4AB • 0118 929 7500 • Fax: 0118 929 7519
INDIA:	1/5 Eagles Street • Langford Town • Bangalore 560 025 • 080 212 8027 • Fax: 080 212 8005
ITALY:	Viale San Gimignano, 38 • 20146 Milano • 02-48 39 16 01 • Fax: 02-48 30 22 74
JAPAN:	New Pier Takeshiba North Tower 13F • 11-1, Kaigan 1-chome • Minato-ku, Tokyo 105-0022 • 81-3-5733-7555 • Fax: 81-3-5733-7556
KOREA:	2FL., URI Building • 2-14 Yangjae-Dong • Seocho-Gu, Seoul 137-888 • 82-2-574-7778 • Fax: 82-2-574-7838
NETHERLANDS:	Postbus 559 • 4200 AN Gorinchem • 0183-635333 • Fax: 0183-630821
SWEDEN:	c/o Regus Business Centre • Frosundaviks Allé 15, 4tr • 169 70 Solna • 08-509 04 600 • Fax: 08-655 26 10
TAIWAN:	13F-3, No. 6, Lane 99, Pu-Ding Road • Hsinchu, Taiwan, R.O.C. • 886-3-572-9077 • Fax: 886-3-572-9031

Model 82-DOS Simultaneous C-V Instruction Manual

© 1988, Keithley Instruments, Inc.
Test Instrumentation Group
All rights reserved.
Cleveland, Ohio, U.S.A.
May 1988, Fourth Printing
Document Number: 5957-901-01 Rev. D

All Keithley product names are trademarks or registered trademarks of Keithley Instruments, Inc.

Other brand and product names are trademarks or registered trademarks of their respective holders.

The following safety precautions should be observed before using this product and any associated instrumentation. Although some instruments and accessories would normally be used with non-hazardous voltages, there are situations where hazardous conditions may be present.

This product is intended for use by qualified personnel who recognize shock hazards and are familiar with the safety precautions required to avoid possible injury. Read and follow all installation, operation, and maintenance information carefully before using the product. Refer to the manual for complete product specifications.

If the product is used in a manner not specified, the protection provided by the product may be impaired.

The types of product users are:

Responsible body is the individual or group responsible for the use and maintenance of equipment, for ensuring that the equipment is operated within its specifications and operating limits, and for ensuring that operators are adequately trained.

Operators use the product for its intended function. They must be trained in electrical safety procedures and proper use of the instrument. They must be protected from electric shock and contact with hazardous live circuits.

Maintenance personnel perform routine procedures on the product to keep it operating properly, for example, setting the line voltage or replacing consumable materials. Maintenance procedures are described in the manual. The procedures explicitly state if the operator may perform them. Otherwise, they should be performed only by service personnel.

Service personnel are trained to work on live circuits, and perform safe installations and repairs of products. Only properly trained service personnel may perform installation and service procedures.

Keithley products are designed for use with electrical signals that are rated Installation Category I and Installation Category II, as described in the International Electrotechnical Commission (IEC) Standard IEC 60664. Most measurement, control, and data I/O signals are Installation Category I and must not be directly connected to mains voltage or to voltage sources with high transient over-voltages. Installation Category II connections require protection for high transient over-voltages often associated with local AC mains connections. Assume all measurement, control, and data I/O connections are for connection to Category I sources unless otherwise marked or described in the Manual.

Exercise extreme caution when a shock hazard is present. Lethal voltage may be present on cable connector jacks or test fixtures. The American National Standards Institute (ANSI) states that a shock hazard exists when voltage levels greater than 30V RMS, 42.4V peak, or 60VDC are present. **A good safety practice is to expect that hazardous voltage is present in any unknown circuit before measuring.**

Operators of this product must be protected from electric shock at all times. The responsible body must ensure that operators are prevented access and/or insulated from every connection point. In some cases, connections must be exposed to potential human contact. Product operators in these circumstances must be trained to protect themselves from the risk of electric shock. If the circuit is capable of operating at or above 1000 volts, **no conductive part of the circuit may be exposed.**

Do not connect switching cards directly to unlimited power circuits. They are intended to be used with impedance limited sources. NEVER connect switching cards directly to AC mains. When connecting sources to switching cards, install protective devices to limit fault current and voltage to the card.

Before operating an instrument, make sure the line cord is connected to a properly grounded power receptacle. Inspect the connecting cables, test leads, and jumpers for possible wear, cracks, or breaks before each use.

When installing equipment where access to the main power cord is restricted, such as rack mounting, a separate main input power disconnect device must be provided, in close proximity to the equipment and within easy reach of the operator.

For maximum safety, do not touch the product, test cables, or any other instruments while power is applied to the circuit under test. ALWAYS remove power from the entire test system and discharge any capacitors before: connecting or disconnecting cables or jumpers, installing or removing switching cards, or making internal changes, such as installing or removing jumpers.

Do not touch any object that could provide a current path to the common side of the circuit under test or power line (earth) ground. Always make measurements with dry hands while standing on a dry, insulated surface capable of withstanding the voltage being measured.

The instrument and accessories must be used in accordance with its specifications and operating instructions or the safety of the equipment may be impaired.

Do not exceed the maximum signal levels of the instruments and accessories, as defined in the specifications and operating information, and as shown on the instrument or test fixture panels, or switching card.

When fuses are used in a product, replace with same type and rating for continued protection against fire hazard.

Chassis connections must only be used as shield connections for measuring circuits, NOT as safety earth ground connections.

If you are using a test fixture, keep the lid closed while power is applied to the device under test. Safe operation requires the use of a lid interlock.

If  or  is present, connect it to safety earth ground using the wire recommended in the user documentation.

The  symbol on an instrument indicates that the user should refer to the operating instructions located in the manual.

The  symbol on an instrument shows that it can source or measure 1000 volts or more, including the combined effect of normal and common mode voltages. Use standard safety precautions to avoid personal contact with these voltages.

The **WARNING** heading in a manual explains dangers that might result in personal injury or death. Always read the associated information very carefully before performing the indicated procedure.

The **CAUTION** heading in a manual explains hazards that could damage the instrument. Such damage may invalidate the warranty.

Instrumentation and accessories shall not be connected to humans.

Before performing any maintenance, disconnect the line cord and all test cables.

To maintain protection from electric shock and fire, replacement components in mains circuits, including the power transformer, test leads, and input jacks, must be purchased from Keithley Instruments. Standard fuses, with applicable national safety approvals, may be used if the rating and type are the same. Other components that are not safety related may be purchased from other suppliers as long as they are equivalent to the original component. (Note that selected parts should be purchased only through Keithley Instruments to maintain accuracy and functionality of the product.) If you are unsure about the applicability of a replacement component, call a Keithley Instruments office for information.

To clean an instrument, use a damp cloth or mild, water based cleaner. Clean the exterior of the instrument only. Do not apply cleaner directly to the instrument or allow liquids to enter or spill on the instrument. Products that consist of a circuit board with no case or chassis (e.g., data acquisition board for installation into a computer) should never require cleaning if handled according to instructions. If the board becomes contaminated and operation is affected, the board should be returned to the factory for proper cleaning/servicing.

MODEL 82-DOS SPECIFICATIONS

ANALYSIS CAPABILITIES

CONSTANTS: Flatband C and V
Threshold Voltage
Bulk Doping
Effective Oxide Charge
Work Function
Doping Type
Average Doping
Best Depth

GRAPHICS:

Measured: Simultaneous C vs. Gate Voltage
High Frequency C vs. Gate Voltage
Quasistatic C vs. Gate Voltage
Conductance vs. Gate Voltage
Q/t Current vs. Gate Voltage

Calculated: Quasistatic C and Q/t Current vs. Delay Time
Interface Trap Density vs. Trap Energy
Doping vs. Depletion Depth
Ziegler (MCC) Doping vs. Depth
Depletion Depth vs. Gate Voltage
High Frequency $1/C^2$ vs. Gate Voltage
Band Bending vs. Gate Voltage
High Frequency C vs. Band Bending
Quasistatic C vs. Band Bending

VOLTAGE MEASUREMENT

ACCURACY (1 Year, 18°–28°C): $\pm(0.05\% \text{ rdg} + 50\text{mV})$.

RESOLUTION: 10mV.

TEMPERATURE COEFFICIENT (0°–18° & 28°–40°C):
 $\pm(0.005\% + 1\text{mV})/^\circ\text{C}$.

VOLTAGE SOURCE

VOLTAGE	P-P NOISE ¹ (0.1 Hz to 10 Hz)	RESOLUTION
$\leq 20 \text{ V}$	150 μV	10 mV
$> 20 \text{ V to } 120 \text{ V}$	250 μV	100 mV

¹Typically 3 mV up to 75 MHz.

MAXIMUM SWEEP SPAN, $|V_{\text{START}} - V_{\text{STOP}}|$: 40V.

MAXIMUM OUTPUT CURRENT: $\pm 2\text{mA}$ (–0%, +20%).

SWEEP STEP VOLTAGE SELECTIONS: 10mV, 20mV, 50mV, 100mV.

DC OUTPUT RESISTANCE: $<10\Omega$.

GENERAL

READING RATES: 4-1/2 readings per second to one reading every 400 seconds.

DATA BUFFER: 1000 points maximum.

GRAPHICAL OUTPUTS: Computer display or digital plotter supporting HP[®]GL with IEEE-488 interface; also "screen copy" to compatible printer.

DIGITAL I/O: Consists of one output, four inputs, +5V (series limited with 33Ω), and COMMON referenced to IEEE-488 COMMON. Output will drive one TTL load. Inputs represent one TTL load.

MAXIMUM INPUT: 30V peak, DC to 60Hz sine wave.

MAXIMUM COMMON MODE VOLTAGE: 30V maximum, DC to 60Hz sine wave.

OPERATING ENVIRONMENT: 0° to 40°C, 70% non-condensing RH up to 35°C.

STORAGE ENVIRONMENT: –25° to +65°C.

WARM-UP: 2 hours to rated accuracy.

Specifications subject to change without notice.

QUASISTATIC CAPACITANCE*

RANGE	RESOLUTION	ACCURACY (1 Year, 18°–28°C) $\pm(\% \text{rdg} + \text{pF})$	NOISE P-P (typical)
200 pF	10 fF	1.0 + 0.1	$(0.12\% \text{ rdg} + 0.13 \text{ pF}) \times (100 \text{ mV/STEP V}) + 0.01 \text{ pF}$
2 nF	100 fF	0.8 + 0.2	$(0.09\% \text{ rdg} + 0.13 \text{ pF}) \times (100 \text{ mV/STEP V}) + 0.1 \text{ pF}$

TEMPERATURE COEFFICIENT (0°–18° & 28°–40°C):
 $\pm(0.02\% \text{ rdg} + 0.1 \text{ pF})/^\circ\text{C}$.

HIGH FREQUENCY CAPACITANCE*

100 kHz:

RANGE	RESOLUTION	ACCURACY (1 Year, 18°–28°C) $\pm(\% \text{rdg} + \text{pF})$	TEMPERATURE COEFFICIENT (0°–18° & 28°–40°C) $\pm(\% \text{rdg})/^\circ\text{C}$	NOISE P-P
200 pF	10 fF	0.7 + 0.05	0.03	180 fF
2 nF	100 fF	0.9 + 0.5	0.08	1800 fF

1MHz:

RANGE	RESOLUTION	ACCURACY (1 Year, 18°–28°C) $\pm(\% \text{rdg} + \text{pF})$	TEMPERATURE COEFFICIENT (0°–18° & 28°–40°C) $\pm(\% \text{rdg})/^\circ\text{C}$	NOISE P-P
200 pF	10 fF	0.9 + 0.05	0.03	200 fF
2 nF	100 fF	1.4 + 0.5	0.14	400 fF

SHUNT CAPACITANCE LOADING EFFECT: 0.1% of reading additional error per 100pF load with equal shunt load on input and output.

TEST VOLTAGE: 15mV rms $\pm 10\%$.

TEST FREQUENCY TOLERANCE: $\pm 0.1\%$.

*NOTES

Specifications are based on parallel RC model and Quality Factor ≥ 20 .

Assumes proper cable correction and open circuit suppression.

Quasistatic capacitance accuracy is exclusive of noise, for STEP V $\geq 0.05\text{V}$ and DELAY TIME ≤ 1 second. For other parameters, derate by $(5\text{mV/STEP V}) \times (\text{DELAY TIME}/1 \text{ second})$ in pF at 23°C. Double the derating for every 10°C rise in ambient temperature above 23°C.

Typical allowable non-equilibrium current plus leakage current: $<20\text{pA}$ on 200pF range; $<20\text{pA}$ on 2nF range during capacitance measurements.

MINIMUM COMPUTER CONFIGURATION:

IBM AT, PS/2, or 100% compatible DOS 3.2 or greater
640k of memory Hard disk drive
CGA, EGA, VGA, or Hercules Graphics adapter.

IEEE-488 (GPIB) INTERFACE CARDS SUPPORTED:

Using IOtech Driver488 software V2.60 or earlier:

Capital Equipment PC-488, 4x488; IBM GPIB Adapter; IOtech GP488, GP488A, GP488B+, MP488, MP488CT; Keithley PC-488-CEC, 4-488-CEC-0M, 4-488-CEC-1M; Metrabyte KM488-DD, KM488-ROM; National Instruments PC-II, PC-IIA, PC-III.

Using IOtech Driver488 software V2.61:

IOtech GP488B+, MP488, MP488CT

IOtech Personal 488/2 is required for PS/2 operation.

MODEL 82-DOS COMPONENTS:

Model 230-1: Programmable Voltage Source
Model 595: Quasistatic CV Meter
Model 590: 100k/1M CV Analyzer
Model 5909: Calibration Sources
Model 5957: Model 82-DOS CV Software and Manual
Model 5951: Remote Input Coupler—Includes Models:
4801: Low Noise BNC Cable, 1.2m (4 ft.) (5 supplied)
7007-1: Shielded IEEE-488 Cable, 1m (3.3 ft.) (2 supplied)
7007-2: Shielded IEEE-488 Cable, 2m (6.6 ft.) (1 supplied)
7051-2: RG-58C BNC to BNC Cable, 0.6m (2 ft.) (3 supplied)

MODEL 5957 SIMULTANEOUS C-V SOFTWARE

OVERVIEW

INSTRUMENTS CONTROLLED: Model 590/100k/1M C-V Analyzer, Model 595 Quasistatic C-V Meter, Model 230-1 Voltage Source.

SYSTEM ACCESSORIES SUPPORTED: Model 5951 Remote Input Coupler (controlled through the Model 230-1) and Model 5909 Calibration Capacitors.

TESTS: Controls instruments to acquire and analyze C-V data.

Simultaneous Quasistatic and High Frequency C-V Measurement: The KI82CV program controls the Model 82-DOS system to measure high frequency and quasistatic C-V in the same voltage sweep.

High Frequency C-V Measurement: The KI590CV program controls the Model 590/100k/1M to measure 100kHz or 1MHz capacitance and conductance (or resistance) versus voltage.

Quasistatic C-V Measurement: The KI595CV program controls the Model 595 to measure quasistatic capacitance and Q/t versus voltage.

DATA DISPLAY: Graphic or list display of data arrays. Tabular display of calculated parameters.

FILES:

C-V Parameter File (.PAR): Contains all setup parameters for C-V Measurements.

Data Destination Files (.DAT): Each contains C-V curve data, user-input device parameters, and derived results. Compatible with Model 5958.

Cable Calibration File (PKG82CAL.CAL): Contains reference capacitor values and calibration constants to calibrate particular range and frequency combinations of the Model 590/100k/1M and Model 595.

Material Constants File (MATERIAL.CON): Specifies material constants to be used in analysis such as insulator and semiconductor permittivity, bandgap energy, intrinsic carrier concentration, metal work function, and electron affinity.

CAPACITANCE MEASUREMENT CAPABILITY:

Test Signal Frequency: Quasistatic and 100kHz or 1MHz.

Quasistatic Measurement Ranges: 200pF and 2000pF.

100kHz Measurement Ranges: 200pF/200uS, and 2nF/2mS.

1MHz Measurement Ranges: 200pF/2mS, 2nF/20mS.

Bias Voltage: ±120V maximum using Model 595 internal voltage source coupled with Model 230-1 external voltage source.

Bias Voltage Waveform: Stair waveform.

Selectable measurement filter, quasistatic capacitance leakage current correction, and series or parallel device model.

CABLE CALIBRATION PROGRAM: The CABLECAL.EXE Utility controls the Model 590 to correct for cable connection path effects. The menu-driven utility stores reference capacitor values and measured cable calibration parameters for the Model 590 in the PKG82CAL.CAL file. During Model 5957 execution, these parameters are sent to the Model 590 from the file.

ANALYSIS

KI82CV PROGRAM:

MIS Analysis Constants: Oxide capacitance and thickness, gate area, series resistance, equilibrium minimum capacitance, average doping, bulk doping, bulk potential, Debye length, flatband capacitance and voltage, work function difference, threshold voltage, effective oxide charge and charge concentration, device type, best depth, and capacitance gain and offset.

Doping Profile: Interface trap corrected depletion approximation doping versus depletion depth and depth versus gate voltage, Ziegler method Majority Carrier Corrected (MCC) doping profile.

Interface Trap Density: Interface trap density versus trap energy, band bending versus gate voltage and capacitance versus band bending.

KI590CV PROGRAM:

MIS Analysis Constants: Oxide capacitance and thickness, gate area, series resistance, equilibrium minimum capacitance, average doping, bulk doping, bulk potential, Debye length, flatband capacitance and voltage, work function difference, threshold voltage, effective oxide charge and charge concentration, device type, best depth, and capacitance gain and offset.

Doping Profile: Depletion approximation doping versus depletion depth and depth versus gate voltage, Ziegler method Majority Carrier Corrected (MCC) doping profile.

KI595CV PROGRAM:

MIS Analysis Constants: Oxide capacitance and thickness, gate area and capacitance gain and offset.

FILE MERGE PROGRAM: The FILEMRG.EXE utility combines quasistatic C-V data from the Model 5957V2.0 with high-frequency C-V data from KI590CV or from the Model 5958 to create a data file (.DAT) suitable for analysis by both the Model 5957V2.0 and Model 5958.

SYSTEM REQUIREMENTS

RECOMMENDED COMPUTER CONFIGURATION: IBM compatible 80386 with 80287 or 80387 math coprocessor and disk cache, 640kB RAM, hard disk drive, 1.2MB 5¼-inch or 720kB 3½-inch floppy drive, EGA or VGA monitor, Microsoft or Logitech mouse.

MINIMUM COMPUTER CONFIGURATION: IBM AT, PS/2, or 100% compatible, 640kB RAM, hard disk drive, 1.2MB 5¼-inch or 720kB 3½-inch floppy drive.

OPERATING SYSTEM: MS-DOS or PC-DOS 3.2 (minimum).

GRAPHICS ADAPTER: CGA, EGA, VGA (EGA mode), or Hercules Graphics Adapter.

MEMORY and DISK STORAGE REQUIREMENTS: 3MB of hard disk space (prior to installation) and 500kB free conventional RAM.

IEEE-488 (GPIB) INTERFACE CARDS SUPPORTED:

Using IOtech Driver 488 software V2.60 or earlier:

Capital Equipment PC-488, 4x488; IBM GPIB Adapter; IOtech GP488, GP488A, GP488B+, MP488, MP488CT; Keithley PC-488-CEC, 4-488-CEC-0M, 4-488-CEC-1M; Metrabyte KM488-DD, KM488-ROM; National Instruments PC-II, PC-IIA, PC-III.

Using IOtech Driver 488 software V2.61:

IOtech GP488B+, MP488, MP488CT.

IOtech Personal 488/2 is required for PS/2 operation.

COMPATIBLE PRINTERS: Cannon BJ80; C. Itoh Prowriter; C. Itoh 24LQ; Epson FX, RX, MX, LQ1500; HP Think Jet, Laser Jet+; IBM Graphic or Professional; NEC 8023, 8025; NEC Pinwriter P Series; Okidata 92, 93, 192+; Smith Corona D100; Tektronix 4695/6; Toshiba 24 pin.

COMPATIBLE PLOTTERS: Epson HI-80; Hewlett-Packard 7470, 7475, 7440; Houston DMP-XX; Roland DXY-800; Watanabe Digi-Plot.

COMPATIBLE MOUSE: Microsoft or Logitech mouse with MOUSE.SYS installed.

MATERIALS PROVIDED:

Instruction manual.

Diskettes containing installation, programs, source code, and sample data.

*Note: Microsoft BASIC 7.1 required to modify source code.

Specifications subject to change without notice.

Table of Contents

SECTION 1 — General Information

1.1	INTRODUCTION	1-1
1.2	FEATURES	1-1
1.3	WARRANTY INFORMATION	1-2
1.4	MANUAL ADDENDA	1-2
1.5	SAFETY SYMBOLS AND TERMS	1-2
1.6	SPECIFICATIONS	1-2
1.7	UNPACKING AND INSPECTION	1-2
1.7.1	Unpacking Procedure	1-2
1.7.2	Supplied Equipment	1-2
1.8	REPACKING FOR SHIPMENT	1-3
1.9	COMPUTER REQUIREMENTS	1-3
1.9.1	Computer Hardware Requirements	1-3
1.9.2	Supported Graphics Card	1-3
1.9.3	Supported IEEE-488 Interfaces	1-3
1.9.4	Recommended Printers and Plotters	1-4
1.9.5	System Software Requirements	1-4
1.10	SERVICE AND CALIBRATION	1-5
1.11	OPTIONAL ACCESSORIES	1-5
1.11.1	Connecting Cables	1-5
1.11.2	Rack Mount Kits	1-5
1.11.3	Software Utilities	1-5

SECTION 2 — Getting Started

2.1	INTRODUCTION	2-1
2.2	HARDWARE CONFIGURATION	2-1
2.2.1	System Block Diagram	2-1
2.2.2	Remote Input Coupler	2-2
2.2.3	System Connections	2-5
2.2.4	IEEE-488 Bus Connections	2-6
2.2.5	Remote Coupler Mounting	2-6
2.3	SYSTEM POWER UP	2-8
2.3.1	Instrument Power Requirements	2-8
2.3.2	Power Connections	2-8
2.3.3	Environmental Conditions	2-8
2.3.4	Warm Up Period	2-8
2.3.5	Power Up Procedure	2-8
2.3.6	Line Frequency	2-9
2.4	COMPUTER HARDWARE AND SOFTWARE INSTALLATION	2-9
2.4.1	Interface Card Installation	2-9
2.4.2	Software backup	2-9
2.4.3	Memory and Hard Disk Considerations	2-10

2.4.4	Model 82 Software Installation	2-10
2.4.5	IEEE-488 Driver Software Installation	2-12
2.4.6	CONFIG.SYS Modification	2-12
2.4.7	Installation Verification	2-12
2.4.8	Plotter and Printer Considerations	2-13
2.4.9	Running the Software	2-14
2.4.10	Default Material Constants	2-15
2.5	SOFTWARE OVERVIEW	2-15
2.5.1	System Reset	2-15
2.5.2	System Characterization	2-15
2.5.3	Compensating for Series Resistance and Determining Device Parameters	2-15
2.5.4	Device Measurement	2-16
2.5.5	Data Analysis and Plotting	2-17
2.5.6	Returning to DOS	2-17
2.6	SYSTEM CHECKOUT	2-17
2.6.1	Checkout Procedure	2-17
2.6.2	System Troubleshooting	2-17

SECTION 3 — Measurement

3.1	INTRODUCTION	3-1
3.2	MEASUREMENT SEQUENCE	3-1
3.3	SYSTEM RESET	3-3
3.4	TESTING AND CORRECTING FOR SYSTEM LEAKAGES AND STRAYS	3-4
3.4.1	Test and Correction Menu	3-4
3.4.2	Parameter Selection	3-5
3.4.3	Viewing Leakage Levels	3-8
3.4.4	System Leakage Test Sweep	3-10
3.4.5	Offset Suppression	3-13
3.5	CORRECTING FOR CABLING EFFECTS	3-13
3.5.1	When to Perform Cable Correction	3-13
3.5.2	Recommended Sources	3-14
3.5.3	Source Connections	3-14
3.5.4	Correction Procedure	3-15
3.5.5	Optimizing Correction Accuracy to Probe Tips	3-15
3.6	CHARACTERIZING DEVICE PARAMETERS	3-15
3.6.1	Device Characterization Menu	3-15
3.6.2	Running and Analyzing a Diagnostic C-V Sweep	3-17
3.6.3	Determining Series Resistance, Oxide Capacitance, Oxide Thickness, and Gate Area	3-19
3.6.4	Determining CMIN and Optimum Delay Time	3-21
3.7	MAKING C-V MEASUREMENTS	3-25
3.7.1	C-V Measurement Menu	3-25
3.7.2	Programming Measurement Parameters	3-25
3.7.3	Selecting Optimum C-V Measurement Parameters	3-29
3.7.4	Manual C-V Sweep	3-29
3.7.5	Auto C-V Sweep	3-31
3.7.6	Using Corrected Capacitance	3-31
3.8	LIGHT CONNECTIONS	3-33
3.8.1	Digital I/O Port Terminals	3-33

3.8.2	LED Connections	3-33
3.8.3	Relay Control	3-33
3.9	MEASUREMENT CONSIDERATIONS	3-35
3.9.1	Potential Error Sources	3-35
3.9.2	Avoiding Capacitance Errors	3-37
3.9.3	Correcting Residual Errors	3-38
3.9.4	Interpreting C-V Curves	3-38
3.9.5	Dynamic Range Considerations	3-40
3.9.6	Series and Parallel Model Equivalent Circuits	3-41
3.9.7	Device Considerations	3-42
3.9.8	Test Equipment Considerations	3-43

SECTION 4 — Analysis

4.1	INTRODUCTION	4-1
4.2	CONSTANTS AND SYMBOLS USED FOR ANALYSIS	4-1
4.2.1	Default Constants	4-1
4.2.2	Raw Data Symbols	4-2
4.2.3	Calculated Data Symbols	4-2
4.3	OBTAINING INFORMATION FROM BASIC C-V CURVES	4-3
4.3.1	Basic C-V Curves	4-3
4.3.2	Determining Device Type	4-4
4.4	ANALYZING C-V DATA	4-4
4.4.1	Plotter and Printer Requirements	4-4
4.4.2	Analysis Menu	4-5
4.4.3	Saving and Recalling Data	4-5
4.4.4	Displaying and Printing the Reading and Graphics Arrays	4-6
4.5	ANALYSIS CONSTANTS	4-10
4.5.1	Oxide Capacitance, Thickness, and Area Calculations	4-12
4.5.2	Series Resistance Calculations	4-12
4.5.3	Changing N_{BULK}	4-14
4.5.4	Changing C_{MIN}	4-14
4.5.5	Flatband Capacitance and Flatband Voltage	4-14
4.5.6	Threshold Voltage	4-14
4.5.7	Metal Semiconductor Work Function Difference	4-15
4.5.8	Effective Oxide Charge	4-15
4.5.9	Effective Oxide Charge Concentration	4-16
4.5.10	Average Doping Concentration	4-16
4.5.11	Best Depth	4-16
4.5.12	Gain and Offset	4-17
4.6	GRAPHICAL ANALYSIS	4-17
4.6.1	Analysis Tools	4-17
4.6.2	Graphing Data	4-18
4.6.3	Reading Array	4-19
4.6.4	Graphics Array	4-20
4.6.5	Graphing the Reading Array	4-20
4.6.6	Doping Profile	4-26
4.6.7	Ziegler (MCC) Doping Profile	4-30

4.6.8	Interface Trap Density Analysis	4-31
4.7	MOBILE IONIC CHARGE CONCENTRATION MEASUREMENT	4-35
4.7.1	Flatband Voltage Shift Method	4-36
4.7.2	Triangular Voltage Sweep Method	4-36
4.7.3	Using Effective Charge to Determine Mobile Ion Drift	4-40
4.8	REFERENCES AND BIBLIOGRAPHY OF C-V MEASUREMENTS AND RELATED TOPICS	4-40
4.8.1	References	4-40
4.8.2	Bibliography of C-V Measurements and Related Topics	4-40

SECTION 5 — Principles of Operation

5.1	INTRODUCTION	5-1
5.2	SYSTEM BLOCK DIAGRAM	5-1
5.3	REMOTE INPUT COUPLER	5-1
5.3.1	Tuned Circuits	5-3
5.3.2	Frequency Control	5-3
5.4	QUASISTATIC C-V	5-3
5.4.1	Quasistatic C-V Configuration	5-3
5.4.2	Measurement Method	5-3
5.5	HIGH FREQUENCY C-V	5-5
5.5.1	High Frequency System Configuration	5-5
5.5.2	High-Frequency Measurements	5-5
5.6	SIMULTANEOUS C-V	5-6

SECTION 6 — Replaceable Parts

6.1	INTRODUCTION	6-1
6.2	PARTS LIST	6-1
6.3	ORDERING INFORMATION	6-1
6.4	FACTORY SERVICE	6-1
6.5	COMPONENT LAYOUTS AND SCHEMATIC DIAGRAMS	6-1

APPENDICES

A	Material Constants File Modification
B	Analysis Constants
C	Summary of Analysis Equations
D	Prefixes of Unit Values
E	Using the Model 590 and 595 Programs
F	Graphic 4.0 Functions Used by Model 82-DOS
G	Cable Calibration Utility
H	File Merge Utility
I	Data File Format
J	Software Modification

List of Illustrations

SECTION 2 — Getting Started

Figure 2-1	System Block Diagram	2-2
Figure 2-2	Model 5951 Front Panel	2-3
Figure 2-3	Model 5951 Rear Panel	2-4
Figure 2-4	System Front Panel Connections	2-5
Figure 2-5	System Rear Panel Connections	2-6
Figure 2-6	System IEEE-488 Connections	2-7
Figure 2-7	Remote Coupling Mounting	2-7
Figure 2-8	Main Menu	2-16

SECTION 3 — Measurement

Figure 3-1	Measurement Sequence	3-2
Figure 3-2	Model 82 Main Menu	3-3
Figure 3-3	Stray Capacitance and Leakage Current Menu	3-4
Figure 3-4	Parameter Selection Menu	3-5
Figure 3-5	Save/Load Parameter Menu	3-7
Figure 3-6	Monitor Leakage Menu	3-9
Figure 3-7	Diagnostic Sweep Menu	3-11
Figure 3-8	Leakage Due to Constant Current	3-12
Figure 3-9	Q/t Curve with Leakage Resistance	3-12
Figure 3-10	Constant Leakage Current Increases Quasistatic Capacitance	3-12
Figure 3-11	Quasistatic Capacitance with and without Leakage Current	3-13
Figure 3-12	Cable Correction Connections	3-14
Figure 3-13	Device Characterization Menu	3-16
Figure 3-14	C-V Characteristics of n-type Material	3-18
Figure 3-15	C-V Characteristics of p-type Material	3-18
Figure 3-16	Series Resistance and Oxide Capacitance	3-20
Figure 3-17	C_{MN} and Delay Time Menu	3-22
Figure 3-18	Q/t and C_Q vs. Delay Time Example	3-23
Figure 3-19	Choosing Optimum Delay Time	3-24
Figure 3-20	Capacitance and Leakage Current Using Corrected Capacitance	3-24
Figure 3-21	Device Measurement and Analysis Menu	3-26
Figure 3-22	Parameter Selection Menu	3-27
Figure 3-23	Manual Sweep Menu	3-30
Figure 3-24	Auto Sweep Menu	3-32
Figure 3-25	Digital I/O Port Terminal Arrangement	3-33
Figure 3-26	Direct LED Control	3-34
Figure 3-27	Relay Light Control	3-34
Figure 3-28	C-V Curve with Capacitance Offset	3-35
Figure 3-29	C-V Curve with Added Noise	3-35
Figure 3-30	C-V Curve Resulting from Gain Error	3-35
Figure 3-31	Curve Tilt Cause by Voltage Dependent Leakage	3-36

Figure 3-32	C-V Curve Caused by Nonlinearity	3-36
Figure 3-33	Normal C-V Curve Results When Device is kept in Equilibrium	3-39
Figure 3-34	Curve Hysteresis Resulting When Sweep is too Rapid	3-39
Figure 3-35	Curve Distortion when Hold Time is too Short	3-40
Figure 3-36	Series and Parallel Impedances	3-41

SECTION 4 — Analysis

Figure 4-1	C-V Characteristics of p-type Material	4-3
Figure 4-2	C-V Characteristics of n-type Material	4-4
Figure 4-3	Data Analysis Menu	4-5
Figure 4-4	Example of Reading Array Print Out	4-7
Figure 4-5	Example of Graphics Array Print Out	4-8
Figure 4-6	Example of Ziegler (MCC) Doping Array Print Out	4-9
Figure 4-7	Analysis Constant Display	4-11
Figure 4-8	G-V Curve without Series Resistance Compensation ($R_{SERIES} \cong 100\Omega$)	4-12
Figure 4-9	G-V Curve with Series Resistance Compensation ($R_{SERIES} \cong 100\Omega$)	4-13
Figure 4-10	Simplified Model used to Determine Series Resistance	4-13
Figure 4-11	Graphics Control Menu	4-18
Figure 4-12	Quasistatic Capacitance vs. Gate Voltage Example	4-21
Figure 4-13	High-Frequency vs. Gate Voltage Example	4-22
Figure 4-14	High-Frequency and Quasistatic Capacitance vs. Gate Voltage Example	4-23
Figure 4-15	Q/t vs. Gate Voltage Example	4-24
Figure 4-16	Conductance vs. Gate Voltage Example	4-25
Figure 4-17	Depth vs. Gate Voltage Example	4-26
Figure 4-18	Doping Profile vs. Depth Example	4-28
Figure 4-19	$1/C^2H$ vs. Gate Voltage Example	4-29
Figure 4-20	Ziegler Doping Profile Example	4-30
Figure 4-21	Band Bending vs. Gate Voltage Example	4-32
Figure 4-22	Quasistatic Capacitance vs. Band Bending Example	4-33
Figure 4-23	High-frequency Capacitance vs. Band Bending Example	4-34
Figure 4-24	Interface Trap Density vs. Energy from Midgap Example	4-35
Figure 4-25	Model for TVS Measurement of Oxide Charge Density	4-37

SECTION 5 — Principles of Operation

Figure 5-1	Model 82-DOS System Block Diagram	5-2
Figure 5-2	Simplified Schematic of Remote Input Coupler	5-2
Figure 5-3	System Configuration for Quasistatic C-V Measurements	5-3
Figure 5-4	Feedback Charge Method of Capacitance Measurements	5-4
Figure 5-5	Voltage and Charge Waveforms for Quasistatic Capacitance Measurement	5-4
Figure 5-6	System Configuration for High Frequency C-V Measurements	5-5
Figure 5-7	High Frequency Capacitance Measurement	5-6
Figure 5-8	Simultaneous C-V Waveform	5-7

List of Tables

SECTION 1 — General Information

Table 1-1	Supplied Equipment	1-2
Table 1-2	Computer Hardware Requirements	1-3
Table 1-3	Graphics Cards Supported by Model 82-DOS	1-3
Table 1-4	IEEE-488 Interfaces Supported by Model 82-DOS	1-3
Table 1-5	Recommended Printers	1-4
Table 1-6	Recommended Plotters	1-4
Table 1-7	System Software Requirements	1-4

SECTION 2 — Getting Started

Table 2-1	Supplied Cables	2-5
Table 2-2	Default Directories	2-10
Table 2-3	Graphics Cards Supported by Model 82-DOS	2-11
Table 2-4	Supported Printers and Plotters	2-12
Table 2-5	System Troubleshooting Summary	2-17

SECTION 3 — Measurement

Table 3-1	Cable Correction Sources	3-14
Table 3-2	Digital I/O Port Terminal Assignments	3-33
Table 3-3	Converting Series-parallel Equivalent Circuits	3-42

SECTION 4 — Analysis

Table 4-1	Default Material Constants	4-2
Table 4-2	Analysis Constants	4-10
Table 4-3	Graphical Tools	4-17

SECTION 1

General Information

1.1 INTRODUCTION

This section contains overview information for the Model 82-DOS Simultaneous C-V system and is arranged as follows:

- 1.2 Features
- 1.3 Warranty Information
- 1.4 Manual Addenda
- 1.5 Safety Symbols and Terms
- 1.6 Specifications
- 1.7 Unpacking and Inspection
- 1.8 Repacking for Shipment
- 1.9 Computer Requirements
- 1.10 Service and Calibration
- 1.11 Optional Accessories

1.2 FEATURES

Model 82-DOS is a computer-controlled system of instruments designed to make simultaneous quasistatic C-V and high frequency (100kHz and 1MHz) C-V measurements on semiconductors. Each system includes a Model 590 C-V Analyzer for high-frequency C-V measurements, and a Model 595 Quasistatic C-V Meter, along with the necessary input coupler, connecting and control

cables, and cable calibration sources. A Model 230-1 Voltage Source is also included.

Key Model 82-DOS features include:

- Remote input coupler to simplify connections to the device under test. Both the Model 595 and the Model 590 are connected to the device under test through the coupler, allowing simultaneous quasistatic and high frequency measurement of device parameters with negligible interaction between instruments.
- Supplied menu-driven software allows easy collection of C, G, V, and Q/t data with a minimum of effort. No computer programming knowledge is necessary to operate the system.
- Data can be stored on disk for later reference or analysis.
- File merge utility allows sequentially-measured quasistatic and high-frequency C-V data to be combined for later analysis.
- Graphical analysis capabilities allow plotting of data on the computer display as well as hard copy graphs using an external digital plotter. Graphical analysis for such parameters as doping profile and interface trap density vs. trap energy is provided.
- Supplied external voltage source (Model 230-1) extends the DC bias capabilities to $\pm 120V$.
- Supplied calibration capacitors to allow compensation for cable effects that would otherwise reduce the accuracy of 100kHz and 1MHz measurements.
- All necessary cables are supplied for easy system hook up.

- Supplied INSTALL program simplifies software installation.
- Supplied cable calibration utility corrects for cabling effects.

1.3 WARRANTY INFORMATION

Warranty information is located on the inside front cover of this instruction manual. Should you require warranty service, contact your Keithley representative or the factory for further information.

1.4 MANUAL ADDENDA

Any improvements or changes concerning the Model 82-DOS or this instruction manual will be explained on a separate addendum supplied with the package. Please be sure to note these changes and incorporate them into the manual before operating or servicing the system.

Addenda concerning the Models 230-1, 590, 595, and 5909 will be packed separately with those instruments.

1.5 SAFETY SYMBOLS AND TERMS

The following safety symbols and terms may be found on one of the instruments or used in this manual:

The  symbol on an instrument indicates that you should consult the operating instructions in the associated manual.

The **WARNING** heading used in this and other manuals cautions against possible hazards that could lead to personal injury or death. Always read the associated information very carefully before performing the indicated procedure.

A **CAUTION** heading outlines dangers that could damage the instrument. Such damage may invalidate the warranty.

1.6 SPECIFICATIONS

Detailed specifications for the Model 82-DOS system can be found at the front of this manual. Specifications for the individual instruments are located in their respective instruction manuals.

1.7 UNPACKING AND INSPECTION

1.7.1 Unpacking Procedure

Upon receiving the Model 82-DOS, carefully unpack all instruments and accessories from their respective shipping cartons, and inspect all items for any obvious physical damage. Report any such damage to the shipping agent at once. Save the original packing cartons for possible future reshipment.

1.7.2 Supplied Equipment

Table 1-1 summarizes the equipment supplied with the Model 82-DOS system.

Table 1-1. Supplied Equipment

Quantity	Description	Application
1	230-1 Voltage Source	Supply $\pm 100V$ DC offset, control 5951 frequency
1	590 C-V Analyzer	Measure 100kHz, 1MHz C and G
1	595 Quasistatic C-V Meter	Measure C, Q/t; supply staircase bias waveform
1	5951 Remote Input Coupler	Connect 590 and 595 to DUT
1	5909 Capacitance Sources	System configuration/calibration
5	4801 Low noise BNC cables (4')	Connect 5951 to DUT and instruments
3	7051-2 BNC cables	Connect instrument control and voltage signals
2	7007-1 Shielded IEEE-488 cables (1m)	Connect instruments to bus
1	7007-2 Shielded IEEE-488 cable (2m)	Connect controller to instrument bus
1	5957 C-V Software Package and manual	Control Model 82 system
1	IOtech Driver488 Software and manual	IEEE-488 bus software driver.

1.8 REPACKING FOR SHIPMENT

Should it become necessary to return any of the instruments for repair, carefully pack them in their original packing cartons (or the equivalent), and be sure to include the following information:

- Advise as to the warranty status of the equipment.
- Write ATTENTION REPAIR DEPARTMENT on the shipping label.
- Fill out and include the service form which is located at the back of this or one of the other instruction manuals.

1.9 COMPUTER REQUIREMENTS

The following paragraphs discuss minimum computer requirements, supported graphics and interface cards, supported plotters and printer, and required system software.

Table 1-2. Computer Hardware Requirements

Description	Requirements
Computer	IBM AT, PS/2, or compatible*
Minimum RAM	640KB
Disk drives	Hard drive, one 1.2MB 5-1/4" or 720KB 3-1/2" floppy disk drive
Monitor/graphics card	Color or monochrome (see Table 1-3)
Instrument interface	IEEE-488 (see Table 1-4)
Plotter/printer interface	Serial, parallel, or IEEE-488 (see Table 1-5, 1-6)

*Compatible 386-based machines such as the Compaq 386 can also be used. NOTE: When using Compaq portable, select IBM graphics mode (see Compaq manual). Compaq graphics are not supported.

1.9.1 Computer Hardware Requirements

Model 82-DOS is intended to run on an IBM AT, PS/2, or compatible computer. Compatible 386-based machines such as the Compaq 386 can also be used. Table 1-2 summarizes the required AT computer configuration, including minimum RAM, disk drive complement, and interfaces required.

NOTE

Although not required, a coprocessor is recommended to minimize analysis calculation

times. A 386-based computer is recommended for best performance.

1.9.2 Supported Graphics Cards

Table 1-3 summarizes the graphics cards supported by Model 82-DOS.

Table 1-3. Graphics Cards Supported by Model 82-DOS

Graphics Boards
IBM CGA or 100% compatible
IBM EGA or 100% compatible
IBM VGA or 100% compatible (EGA mode)
Tseng EVA
Tecmar Graphics Master
Hercules Monochrome or 100% compatible
TeleVideo AT
TeleVideo HRCGB
Sigma Color 400
AT & T 6300
Corona PC
Corona PC400
Corona ATP
H.P. Vectra
T. I. Professional
Genoa SuperEGA HiRes

NOTE: VGA operates in EGA mode.

1.9.3 Supported IEEE-488 Interfaces

The computer must be equipped with a suitable IEEE-488 interface so that it can communicate with the Models 230-1, 590, and 595. Table 1-4 summarizes IEEE-488 interfaces supported by Model 82-DOS.

Table 1-4. IEEE-488 Interfaces Supported by Model 82-DOS

Interface	Manufacturer
GP488/GP488A/ Power488	IOtech
PC II, PC IIA, or PC III	National Instruments
PC-488 and 4-488-CEC	Keithley Instruments
GPIB	IBM
GP488/2*	IOtech

*For PS/2 computers

1.9.4 Recommended Printers and Plotters

In order to obtain hard copy plots of your curves, it will be necessary for you to connect a suitable printer or plotter to the serial or parallel port of your computer. Table 1-5 summarizes recommended printers, and Table 1-6 summarizes recommended plotters. Note that the plotters must support HPGL graphics language.

Table 1-5. Recommended Printers

Printer
NEC 8023, 8025, C. Itoh Prowriter Cannon BJ80, Epson FX, RX Okidata 92, 93 Smith Corona D100, Epson MX, IBM Graphics Tektronix 4695/6 C. Itoh 24LQ, Toshiba 24 pin Epson LQ1500, HP Laser Jet+* Okidata 192+ HP Think Jet NEC Pinwriter

*Compatible HP laser printers may also be used.

Table 1-6. Recommended Plotters

Plotter
Hewlett-Packard 7470, 7475, 7440 Watanabe Digi-Plot Houston DMP-XX Roland DXY-800 Epson HI-80

NOTE: All plotters must support HPGL graphics language.

Additional plotter and printer requirements, including how to configure the software for the plotter and printer type, and maximum resolutions are discussed in paragraph 2.4.8.

1.9.5 System Software Requirements

As summarized in Table 1-7, the required installed system software includes MS-DOS or PC-DOS (version 3.2 or higher). IOtech Driver488 is supplied with Model 82-DOS. Microsoft BASIC 7.1 (not supplied) is required only if you intend to modify the software in some way.

Additional information on software installation is covered in paragraph 2.4.

Table 1-7. System Software Requirements

Software	Comments
MS-DOS or PC-DOS, Version 3.2 or higher Microsoft BASIC, Version 7.1* IOtech Driver488** or Driver488/2	Operating system Compile/link source code IEEE-488 interface driver

*BASIC 7.1 is not supplied and is required only for those who wish to modify one of the programs.

**Driver488 is supplied with Model 82-DOS.

1.10 SERVICE AND CALIBRATION

Service and calibration information on the Models 590, 595, and 230-1 can be found in their respective manuals. The Model 5951 Remote Input Coupler cannot be calibrated or repaired by the user, so it must be returned to the factory or authorized service center for repair or calibration. If the Model 5951 is to be returned, proceed as follows:

1. Complete the service form at the back of the manual and include it with the unit.
2. Carefully pack the unit in the original packing carton or its equivalent.
3. Write ATTENTION REPAIR DEPARTMENT on the shipping label.

1.11 OPTIONAL ACCESSORIES

1.11.1 Connecting Cables

Model 4801 Low-noise Cable: Low-noise coaxial cable, 1.2m (48 in.) in length, with a male BNC connector on each end.

Model 4803 Low-noise Kit: Includes 15m (50 ft.) of low-noise coaxial cable, 10 male BNC connectors, and five female chassis-mount BNC connectors.

Model 7007 Shielded IEEE-488 Cables: Shielded IEEE-488 cables with a shielded connector on each end

(metric). Available as Model 7007-1 (1m, 3.3 ft. long), and Model 7007-2 (2m, 6.6 ft. long).

Model 7051 BNC to BNC Cables: 50 Ω (RG-58C) BNC to BNC coaxial cables, available as Model 7051-2 (0.6m, 2 ft. long), Model 7051-5 (1.5m, 5 ft. long), and Model 7051-10 (3m, 10 ft. long).

1.11.2 Rack Mount Kits

Model 1019A-2 Fixed Rack Mount Kit: Mounts the Models 230-1 and 595 side by side in a standard 19-inch rack or equipment cabinet.

Model 2288 Fixed Rack Mount Kit: Mounts the Model 590 in a standard 19 inch rack or equipment cabinet.

Model 8000-14 Equipment Cabinet: A standard 14-inch high, 19 inch wide equipment cabinet, which can be used to enclose the Model 82-DOS instruments. Rack mount kits (above) are also required.

1.11.3 Software Utilities

The Model 5958 C-V Software Utilities add BTS (bias temperature stress) and Zerst (C-t measurement and analysis) capabilities to the Model 82-DOS. A user-supplied Temptronic 0315B Thermochuck is required for the BTS utility.

SECTION 2

Getting Started

2.1 INTRODUCTION

Section 2 contains introductory information to help you get your system up and running as quickly as possible. Section 3 contains more detailed information on using the Model 82-DOS system.

Section 2 contains:

- 2.2 **Hardware Configuration:** Details system hardware configuration, cable connections, and remote input coupler mounting.
- 2.3 **System Power Up:** Covers the power up procedure for the system, environmental conditions, and warm up periods.
- 2.4 **Computer Hardware and Software Installation:** Outlines methods for installation of the computer software and hardware.
- 2.5 **Software Overview:** Describes the purpose and overall configuration of the Model 82-DOS software.
- 2.6 **System Checkout:** Gives the procedure for checking out the system to ensure that everything is working properly.

2.2 HARDWARE CONFIGURATION

The system block diagram and connection procedure are covered in the following paragraphs.

2.2.1 System Block Diagram

An overall block diagram of the Model 82-DOS system is shown in Figure 2-1. The function of each instrument is as follows:

Model 230-1 Voltage Source: Supplies a DC offset voltage of up to $\pm 100\text{V}$, and also controls operating frequency of the Model 5951 Remote Input Coupler.

Model 590 C-V Analyzer: Supplies a 100kHz or 1MHz test signal and measures capacitance and conductance when making high-frequency or simultaneous C-V measurements.

Model 595 C-V Meter: Measures low-frequency (quasi-static) capacitance and Q/t , and also supplies the stepped bias waveform ($\pm 20\text{V}$ maximum) for simultaneous low- and high-frequency C-V measurement sweeps.

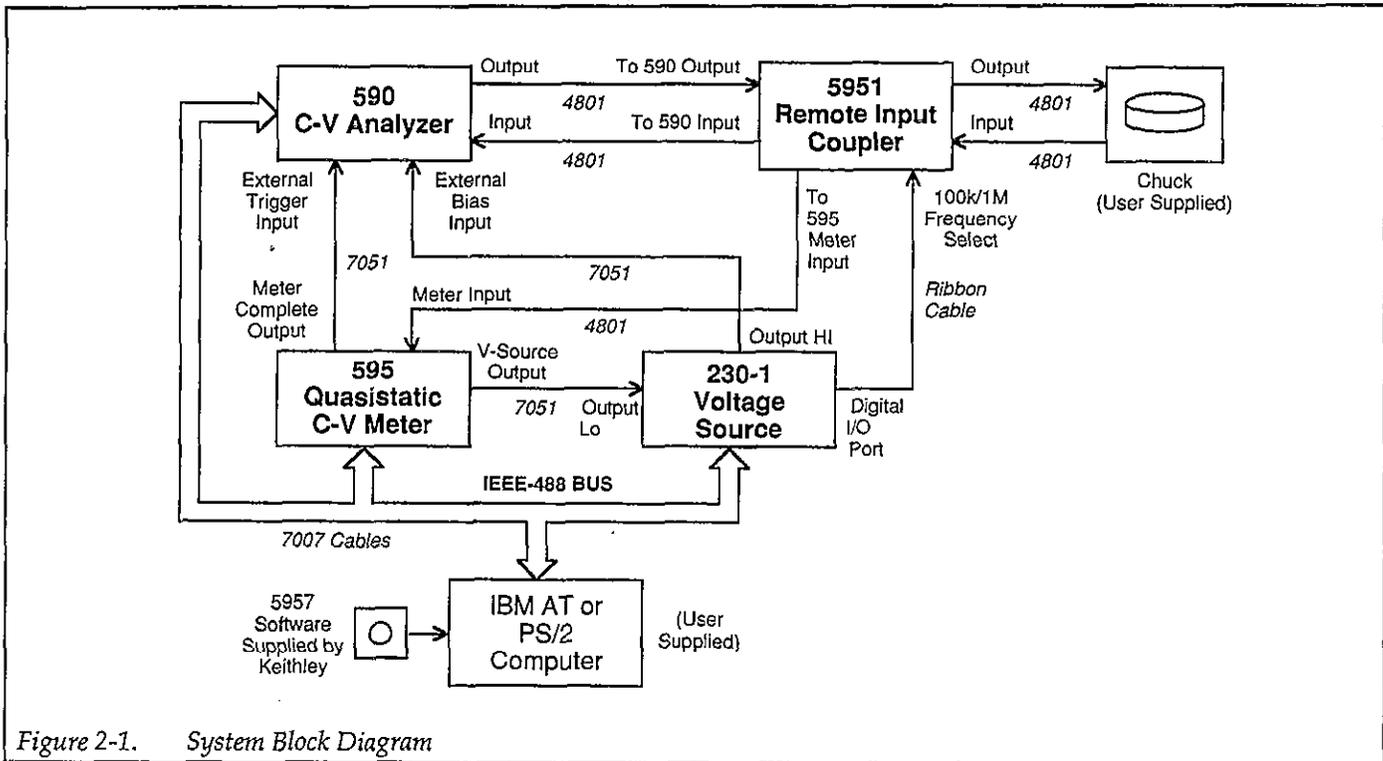

Figure 2-1. System Block Diagram

Model 5951 Remote Input Coupler: Connects the Model 590 and 595 inputs to the device under test. The input coupler contains tuned circuits to minimize interaction between low- and high-frequency measurements.

Computer (IBM AT or PS/2): Provides the user interface to the system and controls all instruments over the IEEE-488 bus, processes data, and allows graphing of results.

Model 5909 Calibration Set: Provides capacitance reference sources for cable correcting the system to the test fixture.

2.2.2 Remote Input Coupler

The Model 5951 Remote Coupler is the link between the test fixture (which contains the wafer under test) and the

measuring instruments, the Models 590 and 595. The unit not only simplifies system connections, but also contains the circuitry necessary to ensure minimal interaction between the low-frequency measurements made by the Model 595, and the high-frequency measurements made by the Model 590.

The front and rear panels of the Model 5951 are shown in Figure 2-2 and Figure 2-3 respectively. The front panel includes input and output jacks for connections to the device under test, as well as indicators that show the selected test frequency (100kHz or 1MHz) for high-frequency measurements. The rear panel includes a binding post for chassis ground, BNC jacks for connections to the Models 590 and 595, a ribbon cable connector (which connects to the Model 230-1 digital I/O port), and a digital I/O port edge connector providing one TTL output, four TTL inputs, digital common, and +5V DC.

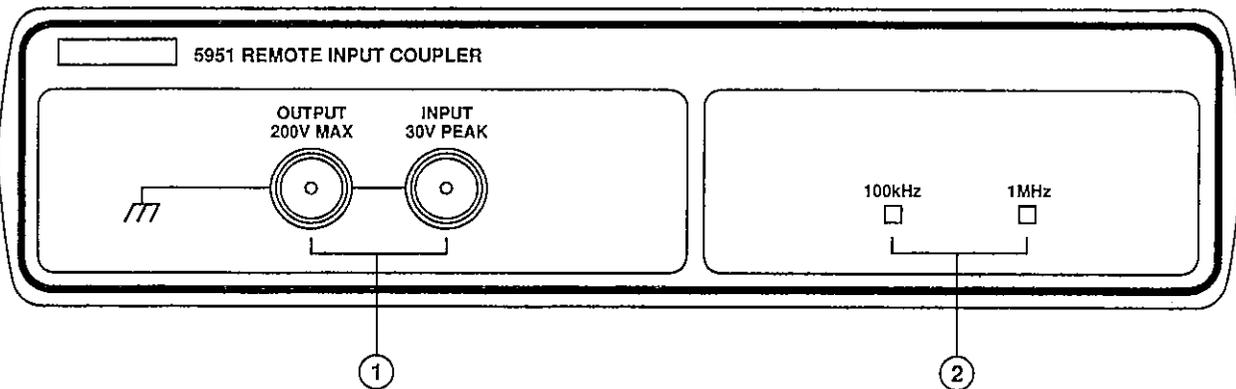

- ① OUTPUT and INPUT — BNC jacks used to connect the Model 5951 to the test fixture containing the device under test.
- ② Frequency indicators (100kHz and 1MHz) — Shows the selected test frequency for high-frequency C-V measurements.

WARNING
Maximum voltage between the outer shell of the BNC jacks and earth ground is 30V RMS. Maximum OUTPUT voltage is 200V; maximum INPUT voltage is 30V peak. Exceeding these values will create a shock hazard.

Figure 2-2. Model 5951 Front Panel

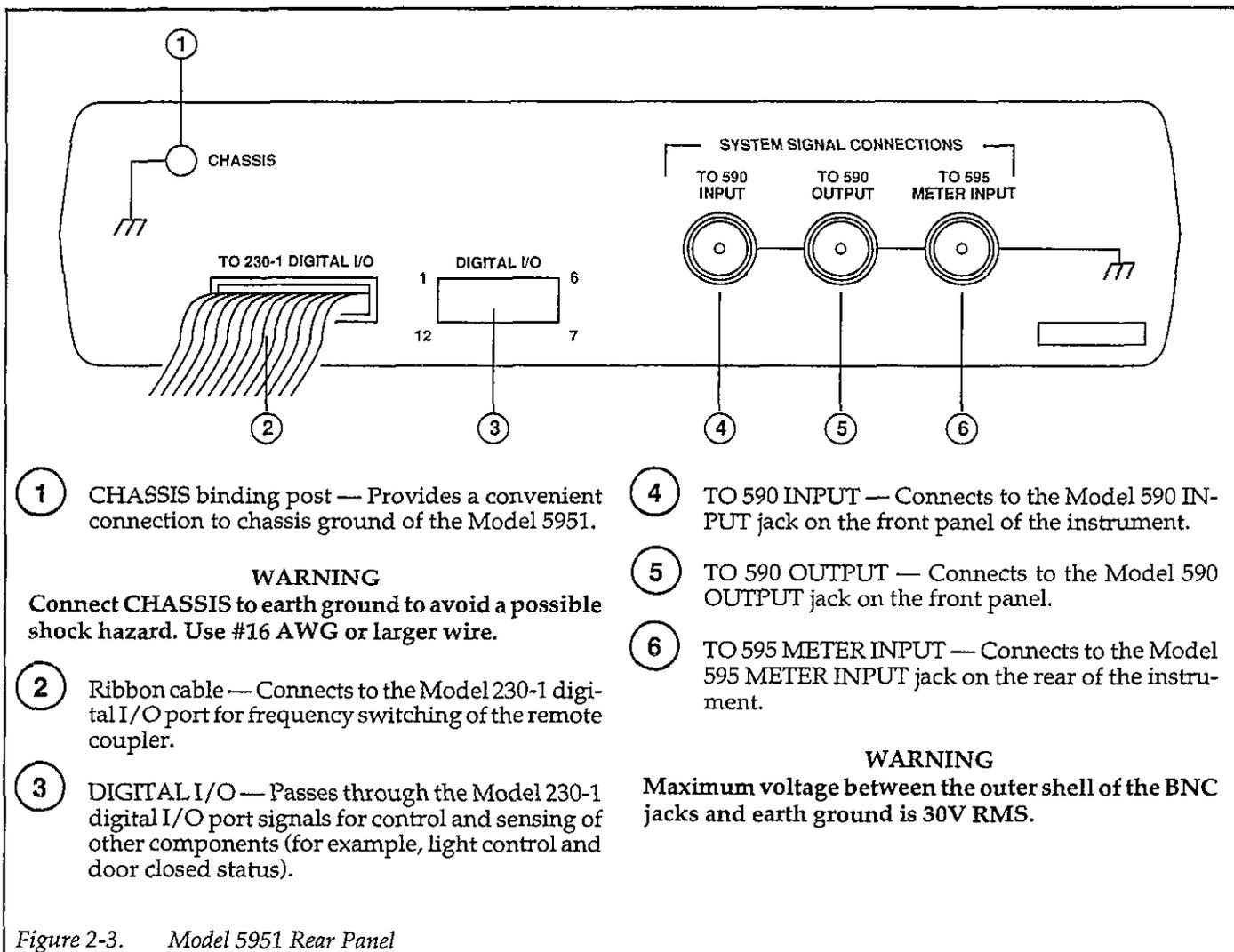

Figure 2-3. Model 5951 Rear Panel

2.2.3 System Connections

Supplied Cables

Table 2-1 summarizes the cables supplied with the Model 82-DOS system along with the application for each cable. Note that low-noise cables are provided for making connections between the chuck and the C-V measurement instruments. The Model 4801 cables are each four feet long. Be careful not to use the Model 7051 BNC cables in place of the low-noise cables (Model 4801), as doing so will have detrimental effects on your measurements.

Connection Procedure

Use Figure 2-4 and Figure 2-5 as a guide and connect the equipment together as follows. Note that the stacked ar-

angement shown in the figures is recommended, but other setups can be used, if desired.

NOTE

All equipment should be turned off when making connections.

1. Connect a Model 4801 cable between the Model 590 INPUT jack and the TO 590 INPUT jack of the Model 5951 Remote Input Coupler. Connect a second Model 4801 between the Model 590 OUTPUT jack and the TO 590 OUT jack of the Model 5951.
2. Connect the Model 5951 INPUT and OUTPUT jacks to the chuck test fixture using Model 4801 cables.

NOTE

OUTPUT should be connected to the substrate contact, and INPUT should be connected to the gate metallization contact. This arrangement will minimize reading noise.

Table 2-1. Supplied Cables

Quantity	Model	Description	Application
5	4801	4' BNC Low Noise	590, 595, 5951
3	7051-2	2' BNC (RG-58)	230-1, 590, 595
2	7007-1	1m shielded IEEE-488	IEEE-488 instrument bus
1	7007-2	2m shielded IEEE-488	Computer to instruments
1	*	Ribbon cable	5951 to 230-1

*Supplied with Model 5951 (Part No. CA-91)

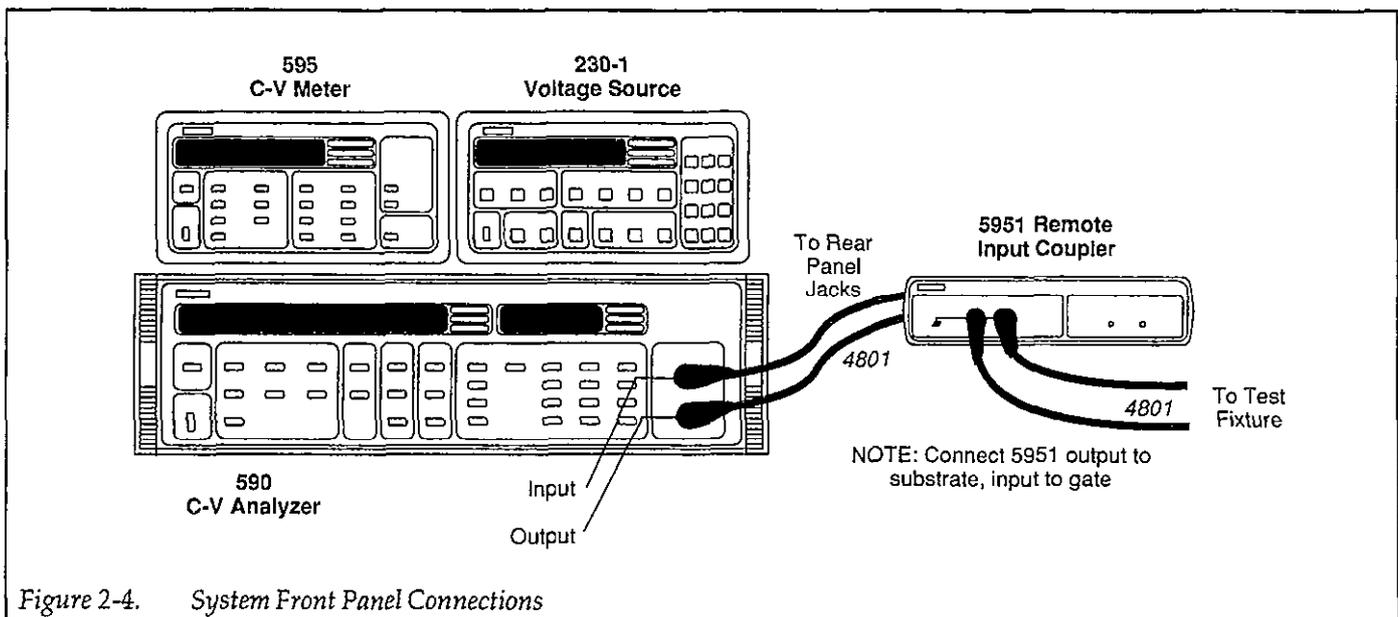

Figure 2-4. System Front Panel Connections

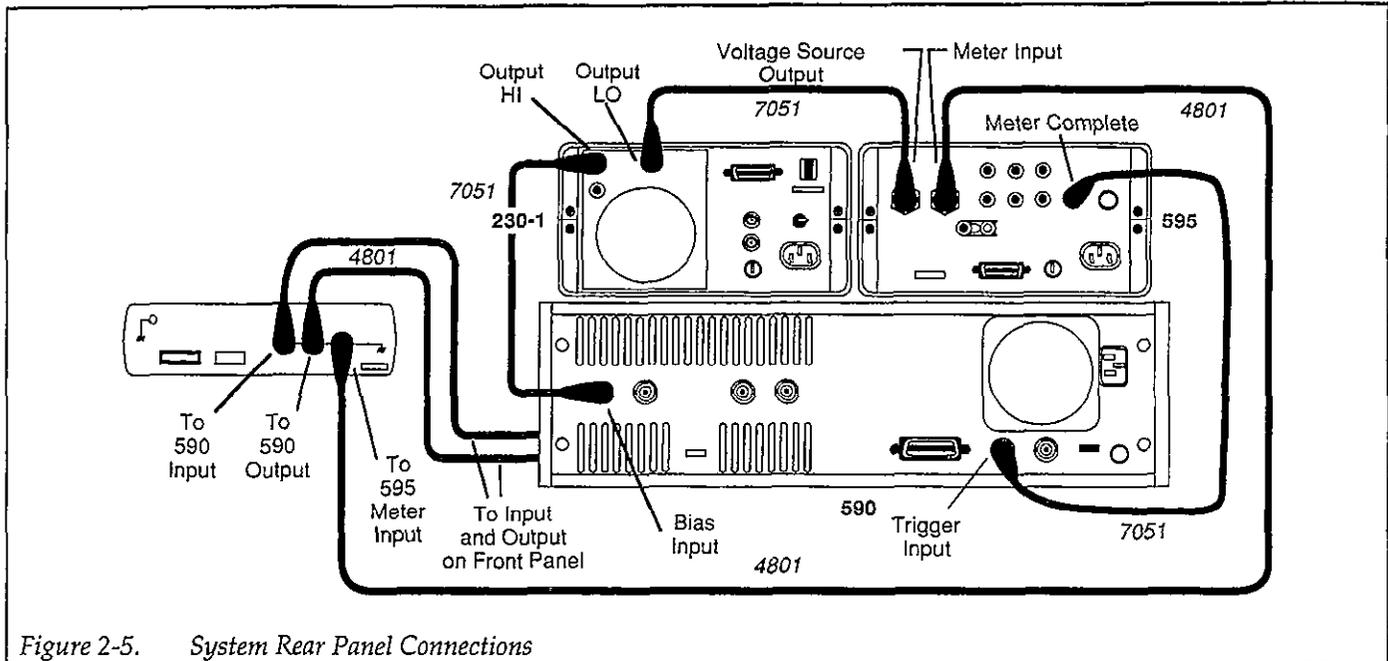

Figure 2-5. System Rear Panel Connections

3. Connect the Model 5951 TO 595 METER INPUT jack to the Model 595 METER INPUT jack using a Model 4801 cable.
4. Connect the ribbon cable to the Model 5951, and then connect the opposite end of the cable to the digital I/O port of the Model 230-1. Both connectors are keyed so that they can be installed only in one direction.
5. Using a Model 7051 cable, connect the Model 595 METER COMPLETE OUTPUT to the EXTERNAL TRIGGER INPUT jack of the Model 590.
6. Using a second Model 7051 BNC cable, connect the Model 595 VOLTAGE SOURCE OUTPUT to the OUTPUT LO of the Model 230-1 Voltage Source. In a similar manner, use a Model 7051 BNC cable to connect the Model 230-1 OUTPUT HI to the EXTERNAL BIAS INPUT of the Model 590 C-V Analyzer.
7. Connect the Model 5951 chassis ground post to earth ground using heavy copper wire.

WARNING

The Model 5951 must be connected to earth ground using #16 AWG or larger wire.

2.2.4 IEEE-488 Bus Connections

In order to use the system, the instruments must be connected to one another and the computer using the sup-

plied IEEE-488 cables. Typically the shorter cables will be used to connect the instruments together, while the longer cable connects the instruments group to the computer. Figure 2-6 shows a typical arrangement for IEEE-488 bus connections. See paragraph 2.4 for a description of IEEE-488 interfaces for the IBM computer.

2.2.5 Remote Coupler Mounting

In many cases, the wafer prober will be located inside a faraday cage to minimize noise. In these situations, the remote coupler itself can also be placed inside the cage for convenience and to minimize cable lengths, assuming of course, there is sufficient room.

The coupler can be permanently mounted to the sides or top of the faraday cage by removing the rubber feet and using the threaded holes in the bottom case for mounting. Appropriate mating holes can be drilled in the faraday cage, and the coupler should be secured to the cage with #6-32 screws of sufficient length.

CAUTION

Be sure that the mounting screws do not extend more than 1/4" inside the Model 5951 case, or they may contact the circuit board inside.

Figure 2-7 shows a typical installation for coupler mounting, including suggested cable routing. Note that the Model 5951 chassis should be grounded to the faraday

cage by connecting a grounding strap or wire between the cage and the coupler chassis ground binding post.

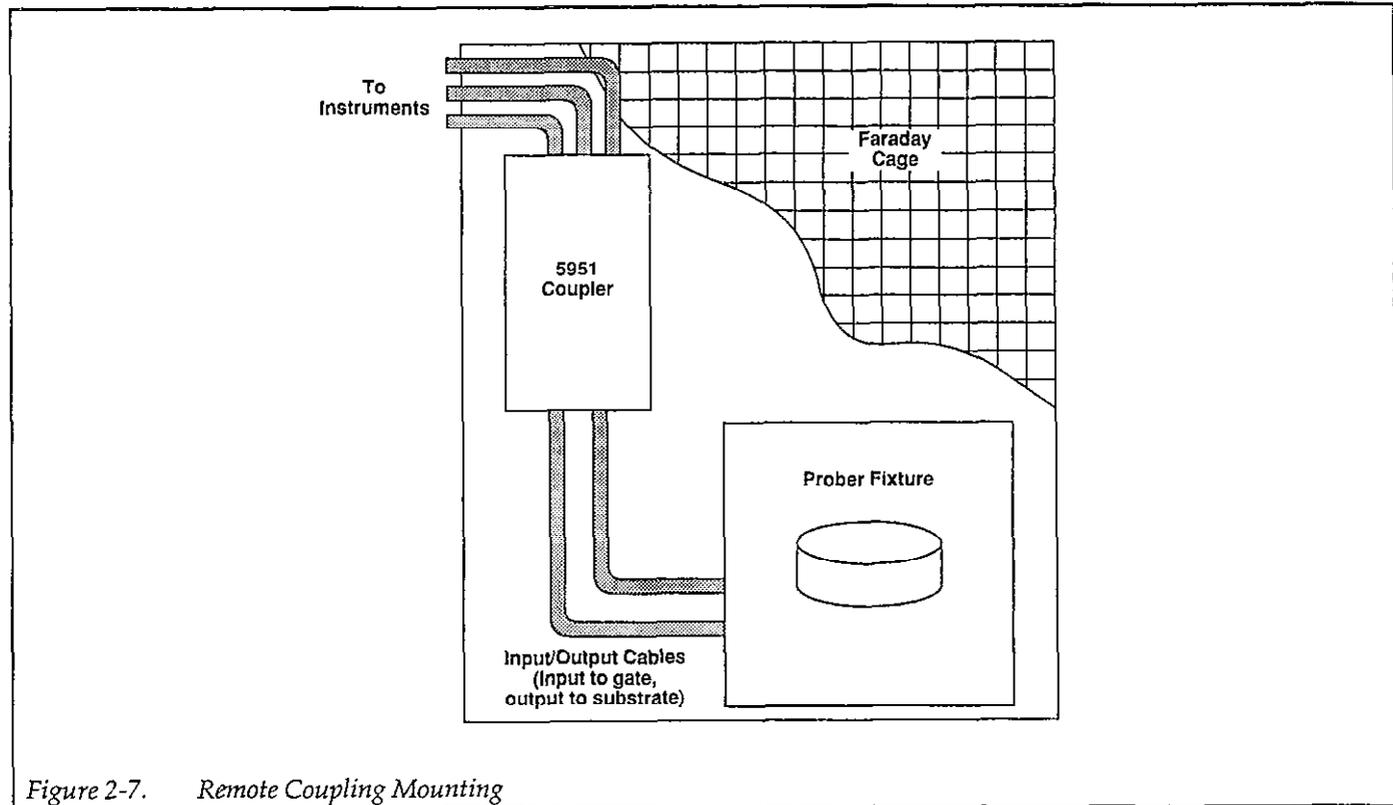
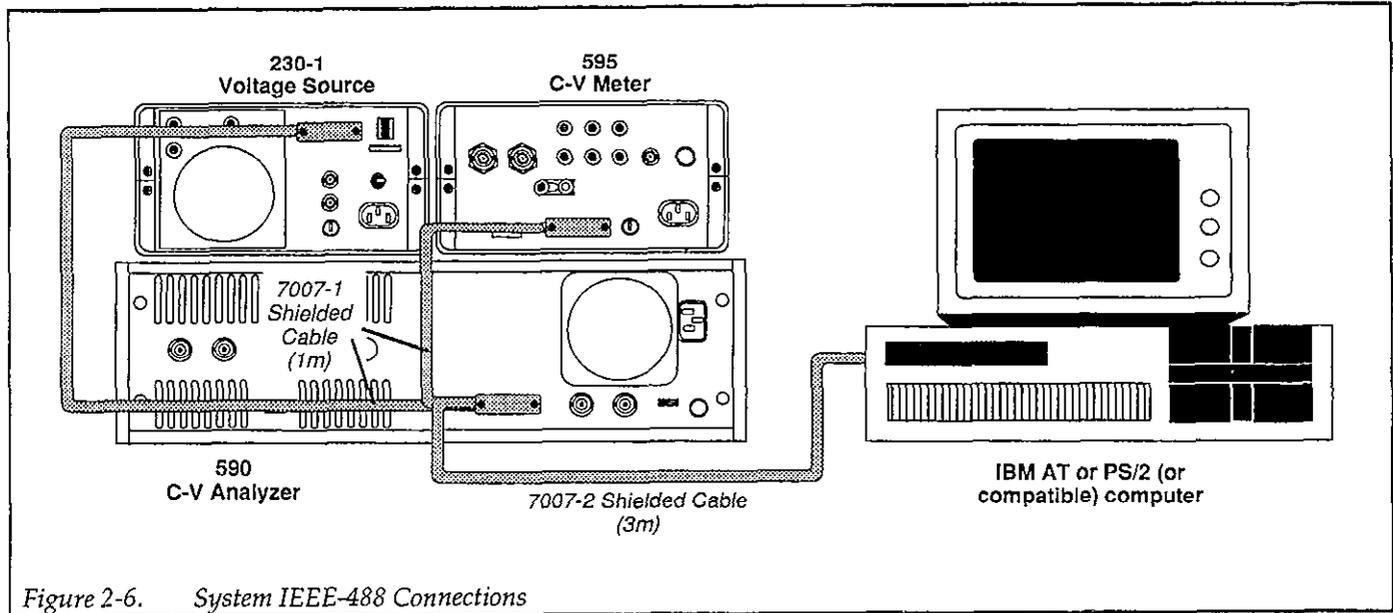

2.3 SYSTEM POWER UP

Line voltage selection, power connections, environmental conditions, and instrument warm-up periods are covered in the following paragraphs.

2.3.1 Instrument Power Requirements

The Model 230-1, 590 and 595 are designed to operate from 105-125V or 210-250V, 50 or 60Hz AC power sources (special transformers can be factory installed for 90-110V and 195-235V AC voltage ranges). The factory setting for each instrument is marked on the rear panel of that particular instrument. The operating voltage for each instrument is either internally or externally selectable; see the appropriate instruction manual for details.

CAUTION

Do not attempt to operate an instrument on a supply voltage outside the allowed range, or instrument damage may occur.

2.3.2 Power Connections

Each instrument should be connected to a grounded AC outlet using the supplied AC power cord or the equivalent.

WARNING

Each instrument must be connected to a grounded outlet using the supplied power cord in order to ensure continued protection from possible electric shock. Failure to use a grounded outlet and a 3-wire power cord may result in personal injury or death because of electric shock.

2.3.3 Environmental Conditions

For maximum measurement accuracy, all instruments and the remote coupler must be operated at an ambient temperature between 0 and 40°C at a relative humidity less than 70%, and within $\pm 5^\circ\text{C}$ of the cable correction temperature.

2.3.4 Warm Up Period

The system can be used immediately when all instruments are first turned on; however, to achieve rated system accuracy, all instruments should be turned on and allowed to warm up for at least two hours before use.

2.3.5 Power Up Procedure

Follow the general procedure below to power up the Model 82-DOS system.

1. Connect the instruments together as outlined in paragraph 2.2.3.
2. Connect the instruments to the IEEE-488 bus of the host computer following the procedure given in paragraph 2.2.4.
3. Turn on the computer and boot up its operating system in the usual manner. Refer to the computer documentation for complete details for your particular system.
4. Turn on each instrument by pressing in its front panel power switch. Verify that each instrument goes through its normal power up routine, as described below.

Model 230-1

1. The instrument first turns on all LEDs and segments.
2. The software revision level is then displayed as in this example:
B13
3. The unit then displays the primary address:
IE 13
Verify the primary address is 13; set it to that value if not.
4. The unit begins normal display.

Model 590

1. The Model 590 first displays the software revision level as in this example:
590 REV D13
2. The instrument then displays the programmed primary address:
IEEE ADDRESS 15
Verify the address is 15; program it for that value if not.

3. Finally, the unit begins displaying normal readings.

Model 595

1. The instrument first displays the ROM self-test message:
r.o.
2. The unit then displays normal readings.
3. Press MENU and verify the primary address is 28; set it to that value if not.

2.3.6 Line Frequency

The Models 230-1 and 590 can be operated from either 50 or 60Hz power sources with no further adjustments. However, for the Model 595 to meet its stated noise specifications, the unit must be programmed for the line frequency being used. To set or check the Model 595 line frequency, proceed as follows:

1. Turn off the Model 595 if it is presently turned on.
2. Press and hold the MENU button and then turn on the power. Release the MENU button after the display blanks on power up.
3. Press the MENU button and note that the frequency selection prompt is displayed:

Fr = 50

or,

Fr = 60

4. Use the ADJUST keys to toggle the unit to the desired frequency.
5. Press SHIFT EXIT to return to normal operation. Note that the frequency selection prompt will remain in the menu until power is removed.

2.4 COMPUTER HARDWARE AND SOFTWARE INSTALLATION

The following paragraphs discuss interface installation and installation of the supplied Model 82-DOS software. Required installation steps include:

- IEEE-488 interface card installation
- Model 82 software installation
- IEEE-488 driver software installation
- CONFIG.SYS file modification.

2.4.1 Interface Card Installation

Model 82-DOS can be used with the following IEEE-488 interfaces:

- IOtech GP488, GP488A, or Power488
- National Instruments PCII, PCIIA, and PCIII
- Keithley Instruments PC-488-CEC and 4-488-CEC
- Capitol Equipment Corp. PC-488 and 4-488
- IBM GPIB
- IOtech GP488/2 (for PS/2)

Note that all the above cards except the GP488/2 can use the Driver488 bus driver supplied with Model 82-DOS.

Before installation, note the following interface board settings so that you can properly configure the bus driver software during driver software installation:

- I/O port address
- DMA status
- Interrupts
- System controller

After noting these settings, install the interface card in the computer. Refer to the documentation supplied with the card for detailed installation procedures.

2.4.2 Software backup

Before installing the software on your hard disk, it is strongly recommended that you make backup copies of each of the disks supplied with Model 82-DOS. Use the DOS DISKCOPY command to make copies. For two-floppy disk systems, the general command syntax is:

```
DISKCOPY A: B: <Enter>
```

Here, the source disk is assumed to be in drive A, and the target (copy) disk is in drive B.

Similarly, the command for single-floppy drive systems is:

```
DISKCOPY A: A: <Enter>
```

After copying all supplied disks, put the original disks away for safekeeping.

2.4.3 Memory and Hard Disk Considerations

In order to use the Model 82-DOS software, you should have at least 500KB free RAM before running the program. A minimum of 4MB of free hard disk space is also recommended. Of course, the amount of space required depends on how many data and parameter files you intend to save.

2.4.4 Model 82-DOS Software Installation

Follow the appropriate procedure below to install the Model 82-DOS software on your hard disk. The following paragraphs discuss using INSTALL.EXE to install the software.

NOTE

INSTALL.EXE can also be used to reconfigure the software after installation. Select the reconfigure option to change an existing software configuration. Also, you can run EQUIP.EXE to change only graphics cards, printers, or plotters settings once installation is complete.

1. Place the installation disk in drive A: or B:, then type:
 A: <Enter>
 or
 B: <Enter>
2. Type the following to start the installation process:
 INSTALL <Enter>
3. Follow the prompts on the screen to select the directories for the various Model 82-DOS files and programs. You can select installation defaults, which are summarized in Table 2-2, or your own directory names, as desired.
4. Continue the installation process by selecting appropriate graphics cards, printers, and plotters at the appropriate prompts. Table 2-3 summarizes graphics cards, and Table 2-4 lists supported printers and plotters. Also, refer to paragraph 2.4.8 below for certain plotter and printer considerations.

NOTE

Model 82-DOS will run properly on most VGA, Super VGA, and 8514 monitor computer systems in the EGA mode. To use Model 82-DOS with any of these graphics systems, select the EGA graphics mode at the appropriate prompt.

Table 2-2. Default Directories

Sub-directory	Contents
C:\KTHLY_CV C:\KTHLY_CV\MODEL82	.EXE, configuration file, config.gpc .FNT or other files needed by .EXE cable calibration file, CABLECAL.EXE; file merge, FILEMRG.EXE
C:\KTHLY_CV\MODEL82\DAT	Data files, *.DAT
C:\KTHLY_CV\MODEL82\PAR	Test files, *.PAR
C:\KTHLY_CV\MODEL82\SRC	Source code, library, and utilities to re-build
C:\IEEE488	IOtech DRIVER488 GPIB board driver software.

NOTE: C:\IEEE488 is not created by Model 82-DOS installation program. Refer to bus driver installation instructions.

Table 2-3. Graphics Cards Supported by Model 82-DOS

Graphics Board	Mode	Resolution (pixels)
IBM color board	monochrome	640 × 200
Tseng EVA		640 × 480
Tecmar Graphics Master	monochrome	720 × 700
	16 color	640 × 400
Hercules Monochrome	monochrome	720 × 348
Enhanced Graphics	16 color	640 × 350
Adapter (EGA)	monochrome	
TeleVideo AT	monochrome	640 × 400
TeleVideo HRCGB	16 color	640 × 400
Sigma Color 400	16 color	640 × 400
AT & T 6300	native graphics	640 × 400
Corona PC	native graphics	640 × 325
Corona PC400	native graphics IBM	640 × 400
	emulation	640 × 200
Corona ATP	monochrome	640 × 400
H.P. Vectra	monochrome	640 × 400
T. I Professional	monochrome	720 × 300
Genoa SuperEGA HiRes	16 color	800 × 600
IBM VGA or compatible	16 color	640 × 480
	monochrome	640 × 480

Table 2-4. Supported Printers and Plotters

Printer/Plotter
C. Itoh Prowriter; NEC 8023; 8025
Epson FX, RX; Cannon BJ80
Okidata 92, 93
IBM Graphic or Professional; Epson MX
Tektronix 4695 ink jet printer
Toshiba P321 and P351 (with unidirectional printing)
Corona Laser printer - REQUIRES AN EXTRA 128k OF MEMORY
Houston DMP-xx plotters
Hewlett-Packard HP-GL plotters
C. Itoh 24LQ
Watanabe Digi-Plot plotter
Epson LQ1500
Smith Corona D100
Epson HI-80 plotter
Hewlett Packard LaserJet+ (or compatible)
Micro Peripherals 150, 180
Okidata 192+ (eight bit graphics)
CALCOMP ColorMaster (BEING TESTED)
Toshiba 1340 (No unidirectional)
HP ThinkJet (SW5 up) (6.5 x 8.5 in.)
Roland DXY-800 Plotter
Toshiba P351C with color ribbon
NEC Pinwriter P series
Quadram QuadLaser (with vector software)
NEC Pinwriter P series with color ribbon

2.4.5 IEEE-488 Driver Software Installation

The driver software for the IEEE-488 interface card should be installed per manufacturer's recommendations. Refer to the IEEE-488 driver software documentation for complete details. Use the supplied Driver488 for all cards except PS/2 cards. Use Driver488/2 for PS/2 cards.

2.4.6 CONFIG.SYS Modification

For most computer configurations, you should assign at least 20 buffers and files in CONFIG.SYS. Use a text editor to modify or add the following lines:

FILES = 20
BUFFERS = 20

NOTE

After modifying CONFIG.SYS, reboot the computer (press Ctrl-Alt-Del) to place the changes into effect.

2.4.7 Installation Verification

Before running the C-V software, it is recommended that you perform the procedure below to make sure that the IEEE-488 interface and software were installed properly.

1. With the power off, connect the instruments to the IEEE-488 interface of the computer.
2. Turn on the instruments, and make sure that their primary addresses are set to the default values (230-1=13, 590=15, 595=28). If not, program or set the primary address(es) accordingly.
3. Turn on the computer, and allow it to boot up DOS in the usual manner.
4. Load interpretive BASIC (BASICA or GW-BASIC) into the computer.
5. Type the lines of the test program below into the computer.
6. RUN the program, then verify that a reading from each instrument appears on the computer CRT, and that each instrument is programmed as follows:

230-1: 10V should be programmed on its display.

590: the unit should display "MODEL 82-DOS" on front panel

595: the instrument should be in the current mode.

If a single instrument fails to respond, check to see that it is programmed for the correct primary address, and that it is connected properly to the IEEE-488 bus. If none of the instruments respond, verify that the interface board and software were properly installed.

TEST PROGRAM

```

10 OPEN "\DEV \ IEEEOUT" FOR OUTPUT AS #1
20 IOCTL#1,"BREAK"
30 PRINT#1,"RESET"
40 OPEN "\ DEV \ IEEEIN" FOR INPUT AS #2
50 PRINT#1,"CLEAR"
60 PRINT #1,"OUTPUT 15;T0,0X"
70 PRINT#1,"ENTER 15"
80 LINE INPUT#2,R$
90 PRINT "MODEL 590 READING: ";R$
100 PRINT#1,"ENTER 28"
110 LINE INPUT#2,R$
120 PRINT "MODEL 595 READING: ";R$
130 PRINT#1,"ENTER 13"
140 LINE INPUT#2,R$
150 PRINT "MODEL 230-1 DATA: ";R$
160 PRINT#1,"OUTPUT 15;DMODEL*82-DOSX"
170 PRINT#1,"OUTPUT 28;F1X"
180 PRINT#1,"OUTPUT 13;V10X"
190 END

```

2.4.8 Plotter and Printer Considerations**Printer Hardcopy Resolution**

Selecting a plotting option on the graphics menu generates a half-page plot with low resolution. To control the size and resolution from the graphics menu, type in one of the following letters:

```

"m"  half page, low resolution
"M"  half page, high resolution
"l"  full page, low resolution
"L"  full page, high resolution

```

Selecting one of these options automatically generates the corresponding plot.

Section 4 discusses analysis in detail.

Plotter Support

Model 82-DOS supports Hewlett-Packard, Watanabe, Houston, and Epson pen Plotters that use the HPGL

graphics language. For HP plotters not listed, first try one of the listed plotters (use 7475A for 7470A).

Those who are using Hewlett-Packard serial plotters should select eight data bits and one stop bit for serial parameters.

Serial Printer and Plotter Support

Model 82-DOS will drive printers or plotters connected to either the serial or parallel port of your computer. If you are using the serial port, you must initialize the port by selecting the proper parameters for your particular serial connection during installation or reconfiguration.

The graphics routines that support hardcopy use polling to send characters to the serial port. Polling means that a character is sent and a check is made to see if the printer is busy. If so, the routine waits until the device is ready to accept another character. However, if the device connected to the serial port sends back any character other than busy, the transmission protocol will be interrupted. For that reason, be sure to set your printer or plotter to its least intelligent mode (turn off handshaking and status reports). Also, be sure to use the proper serial cable, as the interrupt used requires that all signal lines be present.

Laser Printer Support

Model 82-DOS supports a Hewlett-Packard LaserJet + (or compatible) printer with full-page 300dpi resolution. However, the printer must be equipped with at least 1.5Mb of memory to support this resolution. In addition, some computer configurations may have insufficient memory for the required large bit map. In those cases, an "m" (300dpi, 1/2 page) or "l" (150dpi, full page) plot can be performed.

 GPIB (IEEE-488) Bus Plotter Support

A GPIB plotter can be used with Model 82-DOS by selecting the appropriate device(s) from the menu (select the "output to Driver 488 plotter" option). The plotter must, of course, be connected to the IEEE-488 bus of the computer. The plotter must be set for the addressable mode using a primary address of 5.

2.4.9 Running the Software

The following paragraphs discuss the basic procedures for running a Model 82-DOS C-V program. Basically, you can start a C-V program in one of three ways:

- From the main menu.
- From the manual measurement menu, automatically loading a test parameter file.
- From the analysis menu, automatically loading a data file.

Starting the Program at the Main Menu

To execute the program from the main menu, simply type in one of the program names below while in the \KTHLY_CV\MODEL82 subdirectory. C-V programs supplied with Model 82-DOS include:

KI82CV.EXE	This program is the simultaneous C-V program that controls the Models 230-1, 590, and 595 to make simultaneous C-V measurements and perform analysis.
KI590CV.EXE	This program controls the Model 590 alone for high-frequency C-V measurements (see Appendix E).
KI595CV.EXE	This program controls only the Model 595 for quasistatic C-V measurements (see Appendix E).

Note that you need not type in the .EXE extension to execute a program from the DOS prompt. For example, to load and run KI82CV.EXE from the DOS prompt, simply type:

```
KI82CV <Enter>
```

NOTE

The program to be executed must be located in the current default directory to run.

Starting the Program at the Manual Measurement Menu

You can execute the program starting at the manual measurement menu and automatically load a specified test parameter file by including the test parameter file name with the execution command, for example:

```
KI82CV Filename.PAR <Enter>
```

Note that you must specify the .PAR extension to invoke this option. To load parameter file that is not located in the default parameter (.PAR) directory, include the complete path with the file name. If the file is not located in the specified directory, an error message will be displayed and the program will execute from the main menu instead.

Starting the Program at the Analysis Menu

In a similar manner, you can execute the program beginning at the analysis menu and automatically load a specified data file by including the data file name on the command line, for example:

```
KI82CV Filename.DAT <Enter>
```

Note that you must include the .DAT extension to use this option. To load a data file that is not located in the default data (.DAT) directory, include the complete path with the file name (for example, C:\MOREDATA\filename.DAT). If the specified data file is not located in the indicated directory, an error message will be displayed, and the program will begin execution at the main menu.

Default Paths

Normally, the Model 82-DOS software uses the default paths specified during installation for parameter and data files (see Table 2-2). If you specify a new path when loading or saving files, the new path will become the default path for the current session. The default path specified during installation will be restored the next time the C-V program is run.

Run Time Considerations

In order to use Model 82-DOS programs properly, it may be necessary to remove software drivers (such as GPIB print or mouse drivers) from your computer configuration to free up enough memory or to avoid conflicts. Use EDLIN or other text editor to remove the driver installation statements from CONFIG.SYS or AUTOEXEC.BAT as required. Reboot your computer after making modifications before running the Model 82-DOS software.

Also, be careful not to touch front panel buttons on instruments while a program is running. Doing so may change instrument settings and lead to erroneous results.

Navigating Menus

To select a given menu item, simply type the indicated number, and press the <Enter> key. To move up to a previous menu level, simply choose the return menu selection, or press the <Esc> key. At the highest menu level, you will be prompted to select whether or not you wish to return to DOS.

2.4.10 Default Material Constants

As shipped, Model 82-DOS is designed to work with devices with a silicon substrate, a silicon dioxide insulator, and aluminum gate material. You can modify the software for use with other types of materials, if desired. Refer to Appendix A for details.

2.5 SOFTWARE OVERVIEW

The main sections of the Model 82-DOS software are briefly discussed in the following paragraphs. These descriptions follow the order of the main menu shown in Figure 2-8. For detailed information on using the software to make measurements and analyze data, refer to Sections 3 and 4.

2.5.1 System Reset

By selecting option 1 on the main menu, you can easily reset the instruments and the software to default conditions. SDC and IFC commands are sent over the bus to return the instruments to their power-on states and remove any talkers or listeners from the bus. Cable calibration constants are also reloaded by this option.

2.5.2 System Characterization

Option 2 on the main menu allows you to perform a "probes up" characterization of the complete system from the measuring instruments, through the connecting cables and remote coupler, down to the prober level. Characterization is necessary to null out (C_Q , C_H , or G), or remedy leakage currents, resistances, and stray capaci-

tance present in the system that could affect measurement accuracy; the procedure also allows you to verify connection problems.

There are two important aspects to system characterization:

1. Quasistatic capacitance (C_Q), high-frequency capacitance (C_H), conductance (G), and Q/t (current) are measured at a specified bias voltage to determine system contribution of these factors. C_Q , C_H , and G can be suppressed in order to assure maximum accuracy. If abnormally large error terms are noted, the system should be checked for poor connections or other factors that could lead to large errors.
2. Q/t vs. V sweeps can be performed to determine the presence of leakage resistance and external leakage current sources. C vs. V sweeps can be done to test for the presence of voltage dependent capacitance in the system.

See Section 3 for details.

System checkout should be performed whenever the configuration, step V , or delay time is changed. Probes-up suppression should precede every measurement to achieve rated accuracy.

2.5.3 Compensating for Series Resistance and Determining Device Parameters

Option 3 on the main menu allows you to determine optimum parameters for measuring the device under test. Key areas of this process are:

1. A C-V sweep is performed and graphed to determine accumulation and inversion voltages.
2. The device is biased in accumulation to determine R_{SERIES} and C_{OX} .
3. The device is biased in inversion to determine C_{MIN} and equilibrium delay time. A user-supplied light can be controlled to help achieve equilibrium more rapidly.

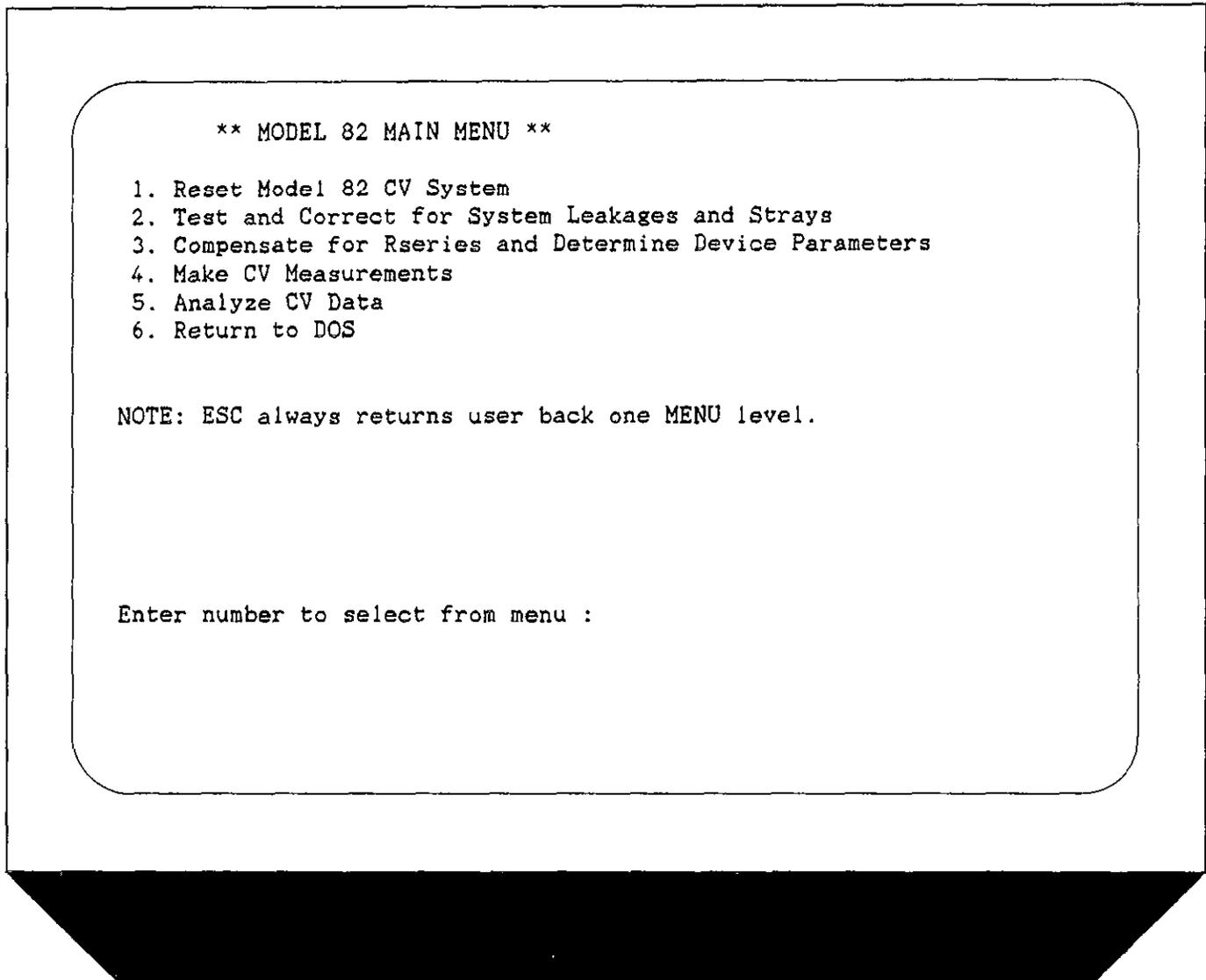

Figure 2-8. Main Menu

2.5.4 Device Measurement

Option 4 on the main menu allows you to perform a simultaneous C-V sweep on the device under test. As parameters are measured, the data are stored within an array for plotting or additional analysis, as required.

The two general types of sweeps that can be performed include:

1. Accumulation to inversion: Initially, the device is biased in accumulation, and the bias voltage is held

static until Q/t reaches the system leakage level. The sweep is then performed and the data are stored in the array.

2. Inversion to accumulation: In this case, the device is first biased in inversion, and the sweep is paused until equilibrium is reached (when Q/t equals the system leakage level). A submenu option allows you to control a light within the test fixture (using the Model 5951 digital I/O port) as an aid in attaining the equilibrium point. The sweep is then completed and the data are stored in an array for further analysis.

2.5.5 Data Analysis and Plotting

Option 5 on the main menu provides a window to a number of analysis and graphing tools. Key options here include printing out parameters, graphing array data on the CRT or plotter, graphical analysis, and loading or storing array data on disk. Note that this option can also be directly selected from menus providing sweep measurements without having to go through the main menu.

2.5.6 Returning to DOS

Selecting option 6 returns you to DOS. IFC and SDC are sent to the instruments before exiting the program.

2.6 SYSTEM CHECKOUT

Use the basic procedure below to check out Model 82-DOS to determine if the system is operational. The procedure requires the use of the Model 5909 Calibration Sources, which are supplied with Model 82-DOS. Note that this procedure is not intended as an accuracy check, but is included to show that all instruments and the system are functioning normally. Before performing this procedure, you should verify that the IEEE-488 interface and software are properly installed (see paragraph 2.4).

2.6.1 Checkout Procedure

1. Connect the system together, as discussed in paragraph 2.2.

2. Power up the system using the procedure given in paragraph 2.3, and boot up the computer.
3. Run KI82CV.EXE.
4. Select option 2 on the main menu, and then option 2 on the subsequent menu. Connect the 1.8nF capacitor and verify that C_Q is within 1% of the 1kHz capacitor value, and that Q/t is $<1pA$. Correct any cabling problems before proceeding.
5. Run the CABLECAL.EXE utility and perform cable correction (see Appendix G).
6. Follow the prompts and connect the Model 5909 Calibration Sources to the Model 5951 INPUT and OUTPUT cables using the BNC adapters supplied with the Model 5909.
7. After correction, return to KI82CV.EXE main menu selection 2, then select option 2 on the submenu. Connect the 1.8nF capacitor; verify that C_Q is within 1% of the 1kHz capacitance, and the C_H is within 1% of the 100kHz of 1MHz value (depending on the selected frequency).
8. Select option 3 on the leakage and strays menu.
9. Start the sweep, and observe the Model 590 voltage display. Verify that the bias voltage readings step through the range of $-2V$ to $+2V$ in 20mV increments.

2.6.2 System Troubleshooting

Troubleshoot any system problems using the basic procedure shown in Table 2-5. For information on troubleshooting individual instruments, refer to the respective instruction manual(s).

Table 2-5. System Troubleshooting Summary

Symptom	Possible Cause(s)
No instrument responds over bus. One instrument fails to respond. Improper low-frequency measurements. Improper high-frequency measurements. 5951 does not change frequency.	Units not connected to controller, controller defective. Unit not connected to bus, improper primary address, unit defective. 595 not connected properly, 595 defective. 590 not connected properly, ribbon cable not connected, 590 defective. Ribbon cable not connected, 5951 or 230-1 defective, loose ribbon cable connection.
No DC bias applied to device. Excessive leakage current. Erratic readings. 590 readings not triggered. Probes up Q/t vs. V improper. Probes up C vs. V improper. Cable correction impossible. Reading dynamic range insufficient.	595 or 230-1 not connected properly, 595 or 230-1 defective. Wrong cables used, dirty jacks, test fixture contamination. EMI interference, poor connections. 595 to 590 trigger cable not connected. External leakage current present. External voltage-dependent capacitance present. Wrong cables used, 590 defective. Connecting cables too long, excessive fixture capacitance.

SECTION 3

Measurement

3.1 INTRODUCTION

This section gives detailed information on using Model 82-DOS Software to acquire C-V data and is organized as follows:

- 3.2 **Measurement Sequence:** Outlines the basic measurement sequence that should be followed to ensure accurate measurements and analysis.
- 3.3 **System Reset:** Describes how to reset the instruments in the system.
- 3.4 **Testing and Correcting for System Leakages and Strays:** Describes the procedure to test the complete system for the presence of unwanted characteristics such as leakage resistance, current, and capacitance.
- 3.5 **Correcting for Cabling Effects:** Details cable correction that must be used in order to ensure accuracy of high-frequency C-V measurements.
- 3.6 **Characterizing Device Parameters:** Covers the procedures necessary to determine R_{SERIES} , C_{MIN} , C_{OX} , and optimum delay time to attain device equilibrium.
- 3.7 **Making C-V Measurements:** Describes in detail the procedures necessary to measure the device under test and store the resulting data in arrays.
- 3.8 **Light Connections:** Discusses connection of a light to the system as an aid in attaining device equilibrium.
- 3.9 **Measurement Considerations:** Outlines numerous factors that should be taken into account in order to maximize measurement accuracy and minimize errors in analysis.

3.2 MEASUREMENT SEQUENCE

The measurements should be carried out in the proper sequence in order to ensure that the system is optimized and error terms are minimized. The basic sequence is outlined below; Figure 3-1 is a flowchart of the sequence.

Step 1: Test and Correct for System Leakage and Strays

Initially, you should test your system to determine if any problems such as excess leakage current or unwanted capacitance are present. You should correct any problems before continuing. Note that the system need be tested only when you change some aspect of its configuration (such as connecting cables or test fixture).

Suppression, which is also available under this menu option, should be performed before each measurement for optimum accuracy. Note that suppression can also be performed from a measurement menu by pressing "Z".

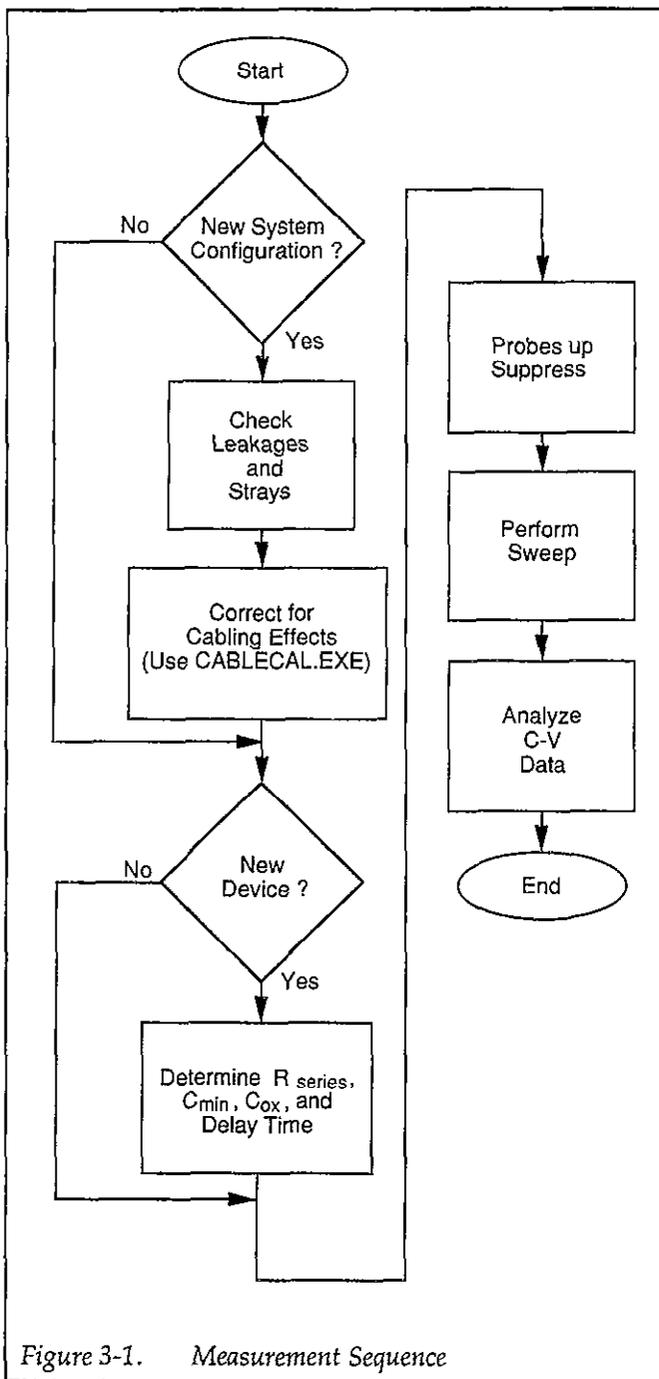

Figure 3-1. Measurement Sequence

Step 2: Correct for Cabling Effects

Cable correction is necessary to compensate for transmission line effects through the connecting cables and remote input coupler, which are more significant at higher frequencies and with longer cables or switches in the system. Failure to perform cable correction will result in substantially reduced accuracy of high-frequency C-V measurements. In order to perform correction, it will be necessary for you to connect the Model 5909 calibration capacitors and use the CABLECAL.EXE utility program. Cable correction must be performed the first time you use your system, and it need be performed only if the system configuration is changed in some manner, or if the ambient temperature changes by more than 5°C.

Step 3: Determine Device Parameters

Each device must be tested to determine optimum accumulation and inversion voltages. Once those voltages values are determined, the device should be biased in accumulation to determine C_{OX} , T_{OX} , and/or gate area, as well as R_{SERIES} . The device under test should then be biased in inversion to determine C_{MIN} and to determine optimum delay time necessary to maintain device equilibrium.

Step 4: Make C-V Measurements

Now that all the "housekeeping", so to speak, is out of the way, a sweep can be performed to determine how such device parameters as capacitance change with applied DC bias voltage. First, of course, it will be necessary for you to select such parameters as range, frequency, and bias voltage values. As the sweep is performed, measured values are stored in arrays for later retrieval and analysis.

Step 5: Analyze C-V Data

Once a sweep has been performed, and the results are stored safely in computer arrays, you can apply any one of a number of different analysis techniques to the data. Raw data plotting (hard copy) or graphing (CRT) of such parameters as low and high frequency capacitance vs. V can be performed. Analysis features including doping profile, flatband calculations, and interface trap density are also provided. See Section 4 for analysis details.

3.3 SYSTEM RESET

Option 1 on the main menu (Figure 3-2) allows you to reset your Model 82-DOS System and return the instruments to their default conditions. When this option is executed, the IEEE-488 IFC (Interface Clear) and SDC (Selective Device Clear) commands are sent over the bus, and you will then be returned to the main menu after a two-second pause. During this period, the computer will display the following message:

Outputting IFC and SDC to reset system.....

The IFC command removes any talkers and listeners from the bus, and the SDC command returns instruments to their default conditions. The Models 230-1 and 595 will always return to the same default state, but the default conditions for the Model 590 are determined by SAVE 0. See the appropriate instruction manuals for details. Note that the instruments are automatically reset when the program is first run and immediately prior to exiting the program.

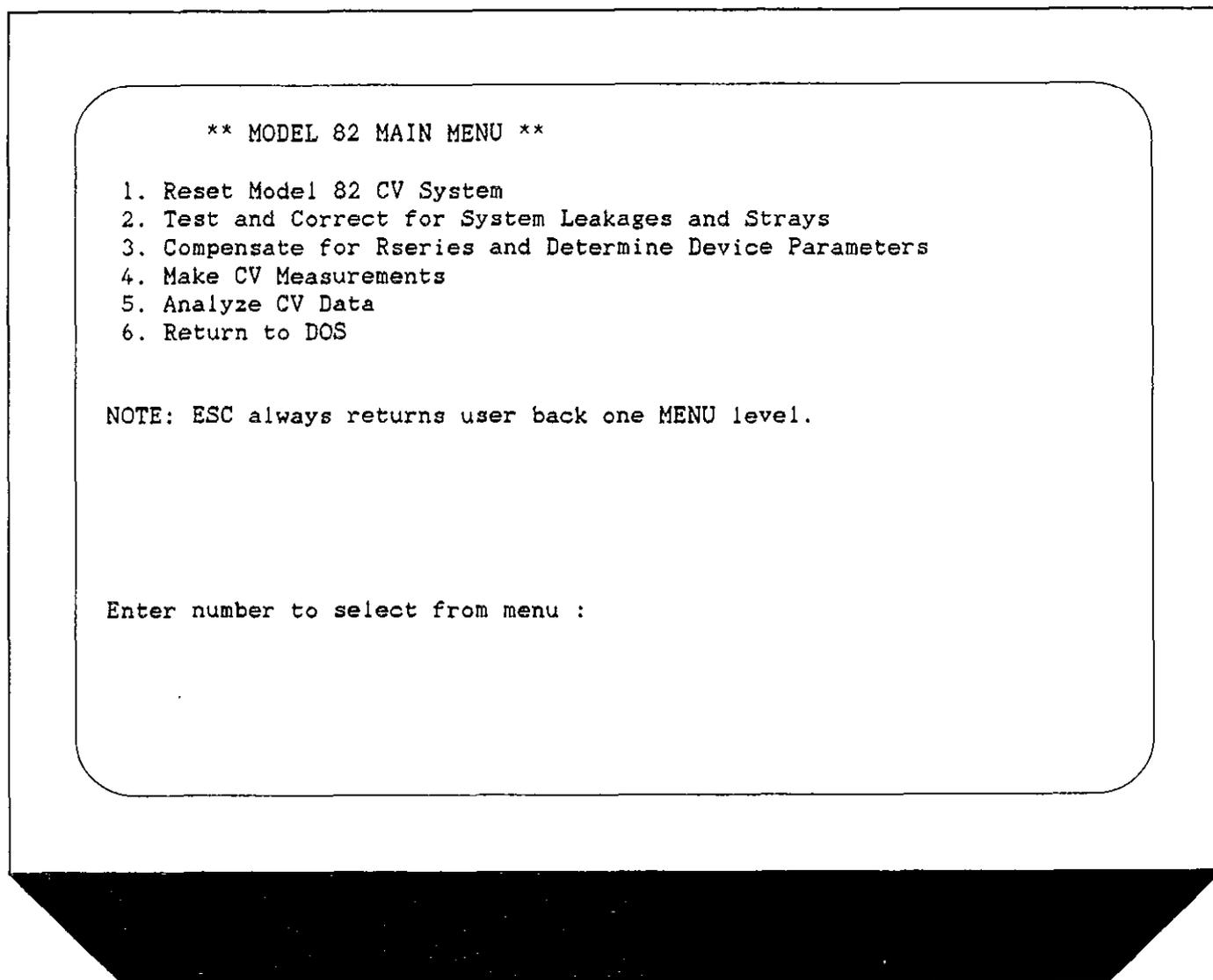

Figure 3-2. Model 82 Main Menu

3.4 TESTING AND CORRECTING FOR SYSTEM LEAKAGES AND STRAYS

The system should be tested with the probes up to determine if any sources of large errors such as defective cables are present. The following paragraphs give an overview of the process, discuss menus, and detail the procedure for testing your particular system.

Suppression should be performed prior to each measurement for optimum accuracy.

3.4.1 Test and Correction Menu

To test your system, select main menu option 2, Test and Correct for System Leakages and Strays.

Figure 3-3 shows the overall test and correction menu for Model 82-DOS software. Through this menu, you can select measurement parameters, monitor leakage levels, perform a probes-up sweep, analyze the results, and suppress offsets. These aspects are covered in the following paragraphs.

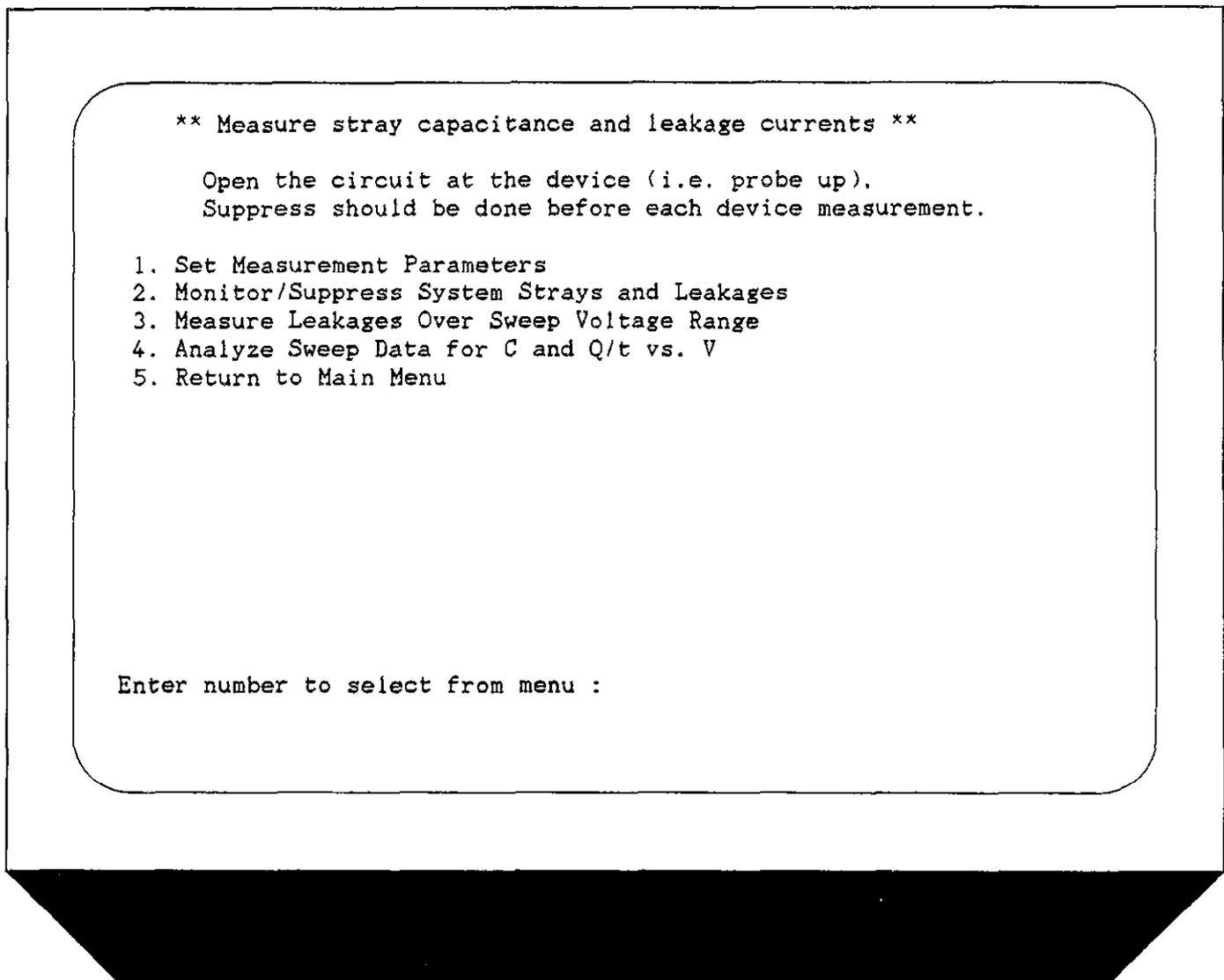

Figure 3-3. Stray Capacitance and Leakage Current Menu

3.4.2 Parameter Selection

Menu Selections

By selecting option 1 on the system testing menu, you can access the parameter selection menu shown in Figure 3-4. You can also access this menu by pressing "M" from measurement menus. This menu allows you to program the following parameters:

1. Range for both quasistatic and high-frequency measurements (200pF or 2nF). The measurement

ranges of both the Models 590 and 595 are set by this parameter.

2. Frequency for high-frequency measurements (100kHz or 1MHz). This parameter sets the operating frequency of the Models 590 and 5951.
3. Model (parallel or series). Model selects whether the device is modeled as a parallel capacitance and conductance, or a series capacitance and resistance. See paragraph 3.9.6.
4. Start V: ($-120 \leq V \leq 120$). Start V is the initial bias voltage setting of a C-V sweep.
5. Stop V: ($-120 \leq V \leq 120$). Stop V is the final bias voltage setting of a C-V sweep.

** Measurement Parameter List **

Range:	2	Enter R1 for 200pF, R2 for 2nF
Freq :	2	Enter F1 for 100KHZ, F2 for 1MHZ
Model:	1	Enter M1 for parallel, M2 for series
Start V:	2.00 V.	Enter An, $-120 \leq n \leq 120$
Stop V:	-2.00 V.	Enter On, $-120 \leq n \leq 120$
Bias V:	0.00 V.	Enter Bn, $-120 \leq n \leq 120$
TDelay:	0.07 sec.	Enter Tn, $0.07 \leq n \leq 199.99$
Step V:	20 mV.	Enter S10, S20, S50 or S100
CCap:	1	Enter C1 for leakage correction off, C2 for on
Filter:	2	Enter I1 for filter off, I2 for on

Number of samples = 93 Sweep will take = 0.4 minutes.

NOTE: 1) Keep start V and stop V within 40 volts of each other.
2) Keep number of samples within 4 and 1000 points with filter off.
3) Keep number of samples within 50 and 1000 points with filter on.

Enter changes one change at a time. Enter E when done, * for files.

Enter selection :

Figure 3-4. Parameter Selection Menu

6. Bias V: Bias V is a static DC level used when static monitoring the system (for example, when testing for leakages and strays), and is the voltage level assumed when a sweep is completed.
7. T delay: ($0.07 \leq T \leq 199.99$ sec). Note that the time delay must be properly set to maintain device equilibrium.
8. Step V: (10mV, 20mV, 50mV or 100mV): Step V is the incremental change in voltage of the bias staircase waveform sweep.
9. C-Cap: (Corrected capacitance): Uses the corrected capacitance program of the Model 595 when enabled. C-Cap should be used only when testing leaky devices.
10. Filter: Sets the Model 595 to Filter 2 when on, Filter 0 (off) when off. NOTE: Turning off the filter will increase the noise by 2.5 times. Note that the parameter does not affect the Model 590 filter, which is always on.
11. Number of Samples: Displayed at bottom of menu.
12. Sweep length: Indicates how long the sweep will take.

Programming Parameters

To program a parameter, type in the indicated menu letter followed by the pertinent parameter. The examples below will help to demonstrate this process.

Example 1: Select 1MHz High-frequency Operation

To select high frequency operation, simply type in F2 at the command prompt, and press the ENTER key.

Example 2: Program a +15V Bias V

Type in B15, and press the ENTER key.

Example 3: Select 0.1sec Delay Time

Type in T0.1, and press the ENTER key.

Example 4: Program a 20mV Step Voltage

Type in S20, and press the ENTER key.

Programming Considerations

When selecting parameters, there are a few points to keep in mind, including:

1. The maximum difference between the programmed Start V and Stop V is 40V. Exceeding this value will generate an error message.
2. The number of points must be between 4 and 1000 with the filter off, or between 50 and 1000 with the filter on to avoid curve distortion.
3. Bias voltage polarity is specified at the gate with respect to the substrate. For example, with a positive voltage, the gate will be biased positive relative to the substrate. Thus, an n-type material must be biased positive to be in the accumulation region.

NOTE

The voltage displayed on the front panel of the Model 590 is of the opposite polarity from the voltage displayed by the Model 82-DOS software because of the gate-to-substrate voltage convention used. As described in Section 2, INPUT should be connected to the gate terminal, and OUTPUT should be connected to the substrate terminal.

Saving/Recalling Parameters

By pressing the "*" key, you can save or load parameters to or from diskette. The menu for these operations is shown in Figure 3-5. Press "S" (save) or "L" (load) to carry out the desired operation. You will then be prompted to type in the filename to be saved or loaded. An error message will be given if a file cannot be found or will be overwritten.

NOTE

Do not add the .PAR extension to the filename.

When the save option is selected, the parameter values currently in effect will be saved under the selected filename. Parameters loaded from an existing file will overwrite existing parameters.

NOTE

To load or save parameters to a different drive or a directory other than PAR, specify the complete path in the filename (for example, A:MYFILE, or C:\PATH\MYFILE).

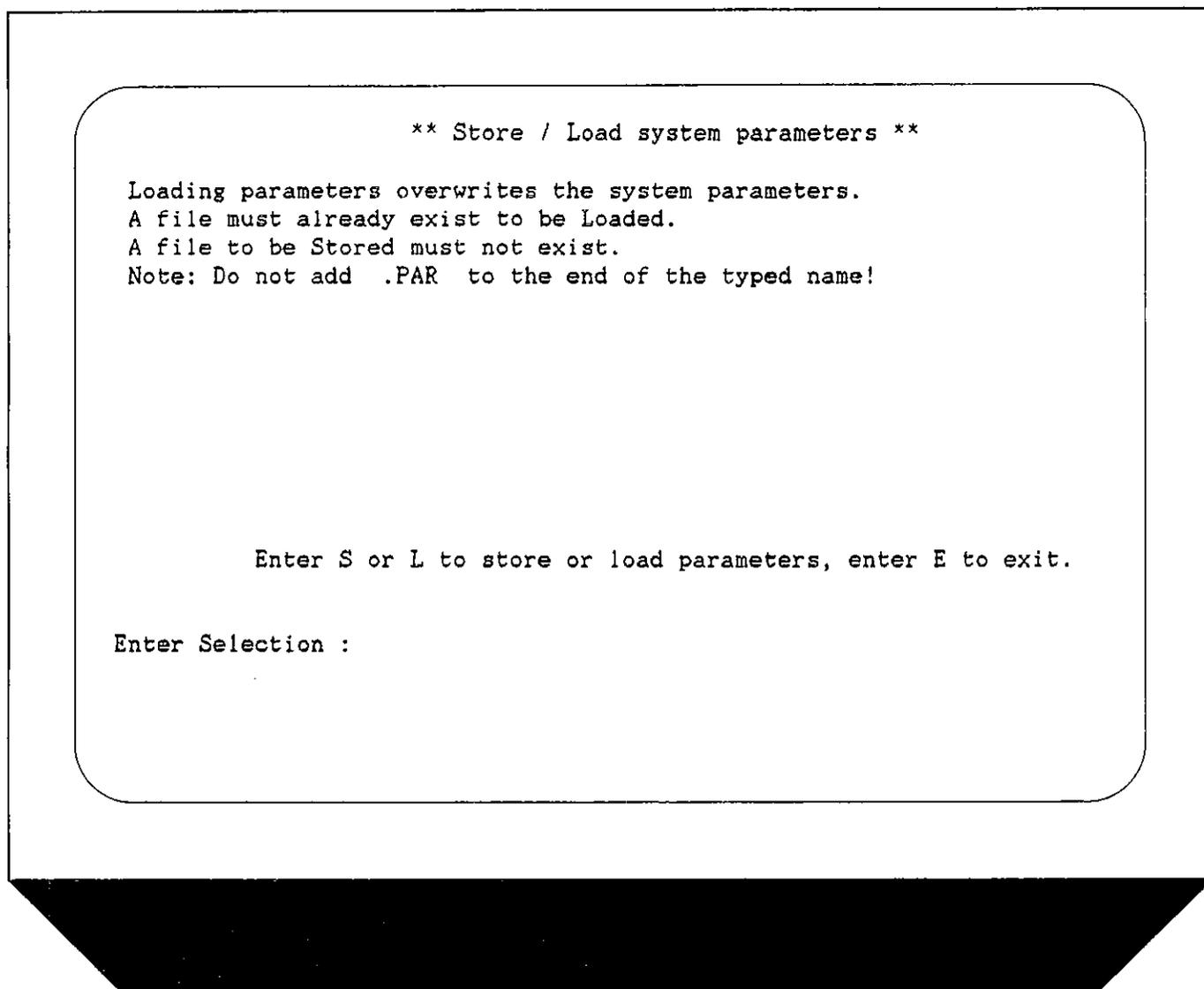

Figure 3-5. Save/Load Parameter Menu

Returning to Previous Menu

After all parameters have been programmed (or loaded from disk), press "E or ESC" to return to the system leakage testing menu.

Loading Parameters at Run Time

A parameter file can be automatically loaded, when the

program is first run by specifying the parameter test filename at run time. See paragraph 2.4.9 for details.

Saving and Loading from a Floppy Disk

To save or load to a floppy disk, simply include the drive designation before the filename. (For example: A: SAMPLE will load or save SAMPLE to drive A:.)

3.4.3 Viewing Leakage Levels

Description

Before performing a test sweep, you should observe system leakage current and capacitance and fix any problems before continuing. Once system leakage levels have been reduced, proceed to paragraph 3.4.4 to perform a probes-up sweep of the system. Paragraph 3.9 discusses these factors in more detail.

Procedure

1. Select option 2 on the main menu followed by option 1 (Set Measurement Parameters) on the following menu. Program the following:

Range: 200pF

Frequency: 100kHz or 1MHz as required

Model: Parallel

Bias V: 0.00V

T Delay: 0.07sec

Step V: 50mV

C-cap: Off

Filter: On

Press "E" then ENTER when parameters have been programmed, then select option 2, Monitor/Suppress System Strays and Leakages.

2. Disconnect the device from the system; in other words, place the probes in the up position. Close the shield on the test fixture.
3. If necessary, press "R" to turn off suppress and display "raw" readings.
4. You will then see a display similar to the one shown in Figure 3-6. The values shown are representative of what to expect in a typical system, but your values may be somewhat different. Note that uncompensated readings are displayed (readings not compensated for series resistance, or gain or offset values).
5. Note the quasistatic and high-frequency capacitance and the leakage (Q/t) level. These values should be as small as possible. Ideally, stray capacitance

should be less than 1% of the capacitance you expect to measure for optimum accuracy. Also, leakage current should be as low as possible.

6. If desired, press "Z" to suppress C_Q , C_H , and G.
7. Press "Q" to exit the menu.

Analyzing the Results

There are two key items to note when performing the above procedure: (1) excessive leakage current (Q/t), and (2) too much stray capacitance. If excessive leakage current is noted, you should check the following:

1. Make sure the proper cables are installed in the correct places. Be certain you have not interchanged Model 4801 (low-noise) cables with the Model 7051 (50Ω) cables.
2. Make sure all connecting jacks and connectors are free of contamination. Clean any dirty connectors with methanol, and allow them to dry thoroughly before use.
3. Be certain that you are, in fact, making a "probes-up" measurement.
4. Check to see that no leakage paths are present in the test fixture.
5. If necessary, tie down cables to avoid noise currents caused by cable flexing. Also, avoid vibration during testing.

Things to check for excessive stray capacitance include:

1. Verify that all cables are of the proper type and not of excessive length.
2. Verify the integrity of all cable shields and that the shield connections are carried through to the connectors.
3. Again, make sure the procedure is being performed in the "probes-up" configuration.
4. Use a test fixture of good, low-capacitance design.
5. Make certain the test fixture shield is in place when characterizing the system. The same precaution holds true when characterizing or measuring a device.

** Monitor/Suppress System Strays and Leakages at Bias V **

Open the circuit at the device (i.e probe up).

press 'M' to set measurement parameters

press 'Z' to suppress Cq, Ch, G (probe up).

press 'R' to remove suppress.

press 'Q' to Quit.

(note: Keyboard response time is affected by delay time)

Suppress is OFF.

UNCOMPENSATED READINGS

Quasistatic :	Cq (pF)	Q/t (pA)	
	+0.5	+0.000	
High freq :	Ch (pF)	G (uS)	Bias Vgs
	-0.3	-2.0000E+00	+0.000

Figure 3-6. Monitor Leakage Menu

3.4.4 System Leakage Test Sweep

Description

This aspect of system leakage testing allows you to determine if there are any voltage-dependent leakages in the system. Basically there are two important points here: (1) how the leakage current varies as the bias voltage changes, and (2) apparent quasistatic capacitance variation with changes in voltage. These considerations are discussed more completely in paragraph 3.9.

Procedure

1. Select option 2 on the main menu, then option 1, Set Measurement Parameters, and program the following parameters.

Range: 200pF

Frequency: 100kHz or 1MHz, as required

Model: Parallel

Start V: Most negative voltage generally used.

Stop V: Most positive voltage usually used.

Bias V: 0.00V

T delay: 0.07sec

Step V: 100mV

C-Cap: Off

Press "E" then ENTER to exit. Select option 3, Measure Leakages Over Sweep Voltage Range.

2. Place the probes in the up position to disconnect the device from the system.
3. Make sure the test fixture shield is in place before starting the procedure.
4. Press "R" to display "raw" readings. The computer display will show leakage levels, as shown in Figure 3-7. Note that uncompensated readings are displayed (reading not compensated for series resistance, or gain and offset values).
5. Press "S" to initiate the sweep. During the sweep, the computer will display the following:

Sweep in progress

Also, the sweep length and voltages will be displayed.

6. At the end of the sweep, select option 4, Analyze Sweep Data, and note the following menu is displayed.
 1. Graph both C_Q and C_H vs. Gate Voltage.
 2. Graph Q/t Current vs. Gate Voltage.
 3. Graph Conductance vs. Gate Voltage.
 4. Return to Previous Menu.
7. Select options 1 and 2 on the menu to graph both quasistatic and high-frequency capacitance vs. gate voltage, and Q/t current vs. gate voltage.

**** Manual Start Sweep Measurement ****

Open the circuit at the device (ie. probe up).
press 'M' to set measurement parameters
press 'Z' to suppress Cq, Ch, G (probe up).
press 'R' to remove suppress.
press 'S' to start the sweep
press 'Q' to Quit.

(note: Keyboard response time is affected by delay time)

Suppress is OFF.

Sweep will take = 0.4 minutes.

UNCOMPENSATED READINGS			
Quasistatic :	Cq (pF)	Q/t (pA)	
	+0.3	+0.000	
High freq :	Ch (pF)	G (uS)	Start Vgs
	-0.3	-3.0000E+00	+1.960

Figure 3-7. Diagnostic Sweep Menu

Analyzing the Results

The leakage current you may observe during testing could be from two main sources: (1) constant leakage currents due to such sources as cables, and (2) voltage-dependent leakage currents caused by leakage resistances. A typical constant leakage current curve is shown in Figure 3-8, while a Q/t curve due to leakage resistance is shown in Figure 3-9. In the first case, note that the current is constant and does not depend on the applied voltage. For the case of the curve dependent on leakage resistance, however, the current is directly proportional to the voltage, as is the case with any common resistor. The resistance, incidentally, is simply the reciprocal of the slope of the line.

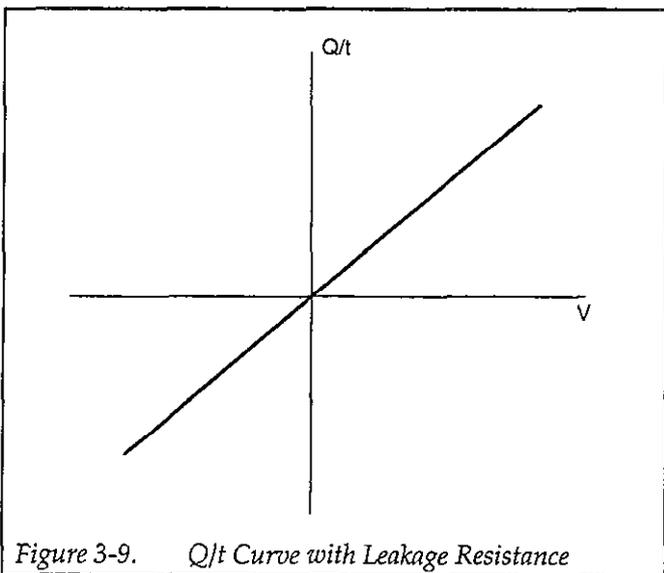
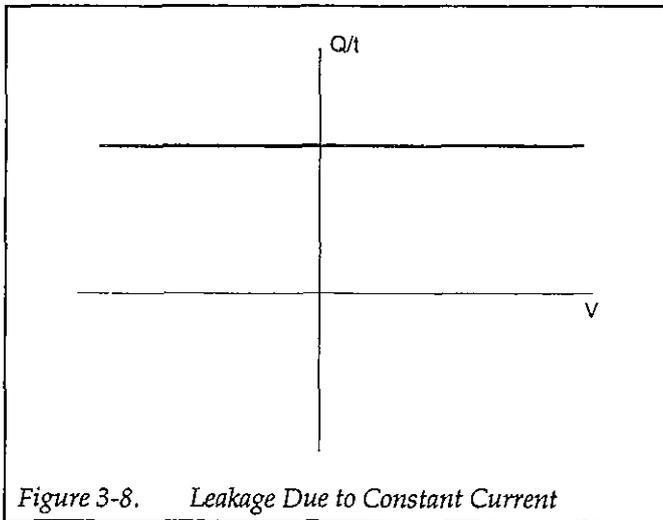

Since quasistatic capacitance is determined by integrating the current, the presence of unwanted leakage current will skew your quasistatic $C-V$ curves. Figure 3-10 shows the effects of constant leakage current. Here, the normal parasitic capacitance, C_p , is skewed upwards with an additional "phantom" capacitance added to the normal parasitic capacitance. The same type of curve skew will also occur with normal measurements, but its effect will usually be less noticeable because of the larger capacitance levels involved.

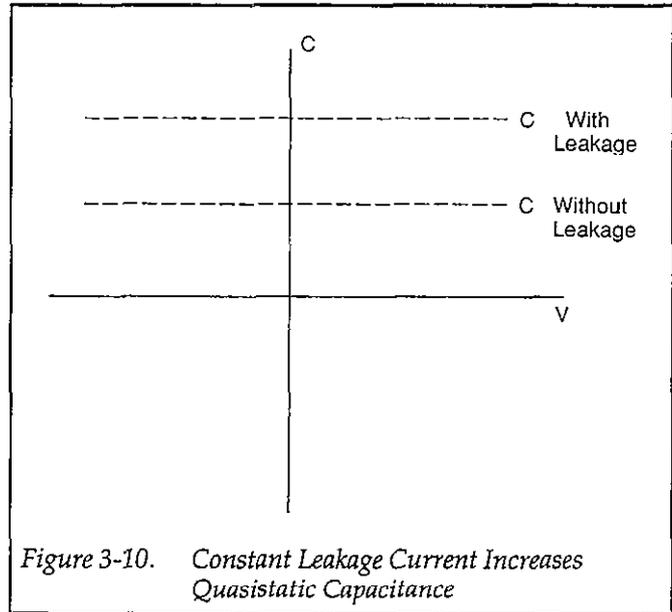

A more serious situation is present in the case of the varying current, as shown in Figure 3-11. Now, the usually flat capacitance curve has been tilted, resulting in what is essentially a voltage-dependent capacitance. Again, the same curve-tilting effects can be expected for normal measurements, although usually to a lesser degree.

The high-frequency capacitance curves will not generally show any voltage-variability, and will show mainly parasitic capacitance at the frequency of interest. Such curves can also provide a good frame of reference for the quasistatic curves, as both quasistatic and high-frequency curves should be flat and very similar as long as leakage currents are sufficiently low.

The G vs. V curve shows AC loss at the selected measurement frequency (100kHz or 1MHz). The high-frequency conductance value may represent a leakage resistance that is AC coupled into the test fixture.

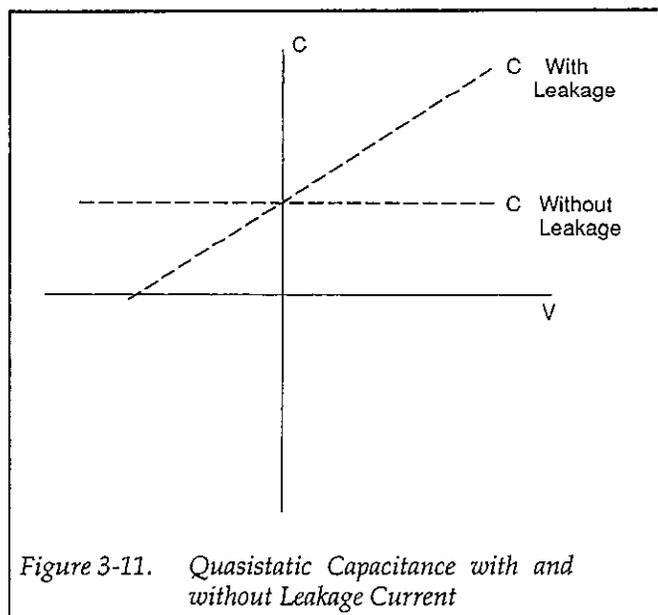

Figure 3-11. Quasistatic Capacitance with and without Leakage Current

3.4.5 Offset Suppression

Description

By selecting option 2 on the system leakage test menu, you can monitor the parameters listed below at a fixed bias voltage. This feature will give you an opportunity to suppress these leakage values to maximize accuracy. This suppression procedure should be carried out before each verified or performed measurement for optimum accuracy.

NOTE

Large leakage capacitances and conductances should not be suppressed. Determine the source of the problem and correct it before using your system if large offsets are noted.

Monitored parameters include:

- C_Q (quasistatic capacitance)
- Q/t (leakage current)
- C_H (high frequency capacitance)
- G (conductance)
- V_{GS} (gate bias voltage)

Suppressed parameters include C_Q , C_H , and G . Note that Q/t is not suppressed. Note that suppress on/off can be

controlled from a measurement menu by pressing "Z" (suppress on) or "R" (suppress off).

Procedure

1. Disconnect the device from the system; in other words, place the probes in the up position. Close the shield on the probe fixture.
2. Select option 2, Monitor/Suppress System Strays and Leakages. You will then see a display similar to the one shown in Figure 3-6. The values shown here are representative of what to expect in a typical system, but yours could be somewhat different.
3. Press "Z" to suppress the leakage values. The Model 590 will be drift corrected, and its zero mode will be enabled to suppress C_H and G . Suppress on the Model 595 will also be enabled to suppress C_Q after a 15-second pause for setting. The status of suppress (on) will be displayed on the screen.
4. Press "Q" to return to the previous menu once suppression is complete.

Disabling Suppress

To disable suppress and display raw readings, simply press "R" at the command prompt. Note that current suppress values will be lost when suppress is disabled.

3.5 CORRECTING FOR CABLING EFFECTS

Cable correction is necessary to optimize accuracy of high-frequency C-V measurements, and to align C_Q and C_H for D_{IT} measurements. The process uses the CABLECAL.EXE utility and involves connecting calibration capacitors with precisely known values to the connecting cables in place of the test fixture.

The following paragraphs discuss required calibration sources as well as the overall cable correction procedure.

3.5.1 When to Perform Cable Correction

Cable correction must be performed the first time you use your system. Thereafter, for optimum accuracy, it is recommended that you cable correct your system whenever the ambient temperature changes by more than 5°C from the previous correction temperature. You can cable correct your system daily, if desired, but doing so is not absolutely essential.

NOTE

Cable correction parameters and source values are stored on disk in the "PKG82CAL.CAL" file. These correction parameters are automatically retrieved during program initialization. This file must be in the default directory when running the program.

3.5.2 Recommended Sources

Table 3-1 summarizes the recommended calibration capacitors, which are part of the Model 5909 calibration set supplied with Model 82-DOS. The values shown are nominal; you must use the 1kHz, 100kHz, and 1MHz values marked on the sources when correcting your system. Space has been provided in Table 3-1 for you to enter the actual values of your sources.

NOTE

The first time you cable correct your system, it will be necessary for you to enter your actual source values while running CABLECAL.EXE. See paragraph 3.5.4.

Table 3-1. Cable Correction Sources

Nominal Value*	1kHz Value**	100kHz Value**	1MHz Value**
47pF			
180pF			
470pF			
1.8nF			

*Nominal values included with Model 5909 Calibration Source
**Enter values from sources where indicated.

3.5.3 Source Connections

In order to correct your system, it will be necessary for you to disconnect your test fixture and connect each cali-

bration capacitor in its place when prompted to do so, as shown in Figure 3-12. Use the supplied female-to-female BNC adapters to connect the sources to the cables.

When using the sources, be sure not to handle them excessively, as the resulting temperature rise will change the source values due to temperature coefficients. This temperature change will degrade the accuracy of the correction process.

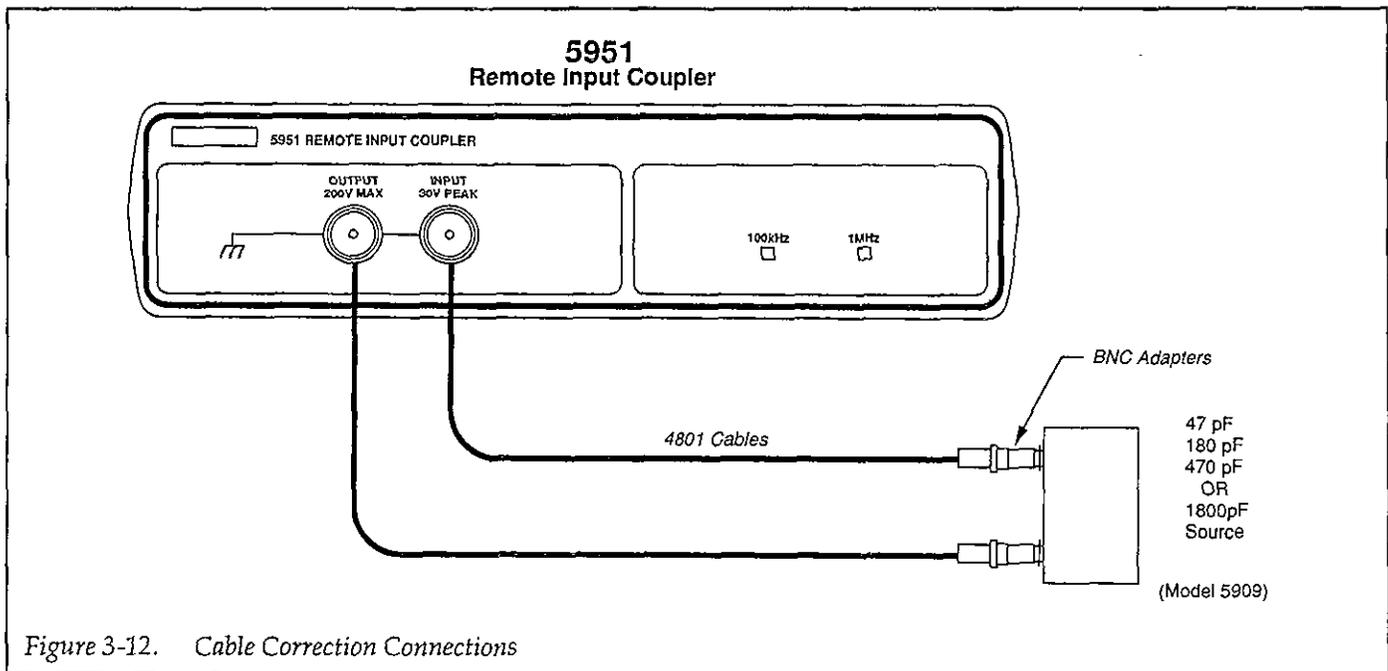

Figure 3-12. Cable Correction Connections

3.5.4 Correction Procedure

As noted earlier, the following procedure must be performed the first time you use your system, and it should also be performed when the ambient temperature changes by more than 5°C from the correction point.

NOTE

This correction procedure uses the CABLECAL.EXE utility, which is described in more detail in Appendix G.

Proceed as follows:

1. While in the \KTHLY_CV\MODEL82 directory, type in the following to run the cable calibration utility:

```
CABLECAL <enter>
```

2. To load an existing PKG82CAL.CAL calibration constants file, press Alt-F, then select Load on the menu. Select the existing PKG82CAL.CAL file, or type in the name of the file (PKG82CAL.CAL).
3. Press Alt-E, then select Cable Cal Model 82 to calibrate the Model 82-DOS system.
4. If you are cable correcting your system for the first time, enter the nominal, 1kHz, 100kHz, and 1MHz values where indicated (use the <Tab> key to move around selections). Capacitor #1 is the smaller of two values, and Capacitor #2 is the large capacitor value for a given range (see Table 3-1). Select OK after entering source values to begin the calibration process.
5. Choose the CALIBRATE selection to perform the cable calibration procedure.
6. Follow the prompts on the screen to complete the calibration process. During calibration, you will be prompted to connect calibration capacitors, or to leave the terminals open in some cases. If any errors occur, you will be notified by suitable messages on the screen.
7. After calibration is complete, you must save the new calibration constants to the PKG82CAL.CAL file in order for the Model 82-DOS main program to find them at run time. To do so, Press Alt-F, the select

Save or Save As as required. If you use Save As, be sure to specify the PKG82CAL.CAL filename.

3.5.5 Optimizing Correction Accuracy to Probe Tips

To correct as close as possible to the probe tips, construct two BNC cables (50Ω, low noise if possible) equal in length to the distance from the last BNC connectors to the probe tips. Connect these substitute cables in place of the last cables with prober, and perform the correction procedure outlined in paragraph 3.5.4. After correction, replace the original cables.

3.6 CHARACTERIZING DEVICE PARAMETERS

Before device measurement, it is necessary to determine sweep parameters to make certain the device is properly biased in inversion and accumulation during the sweep. Also, optimum delay time, t_{DELAY} , must be determined to ensure that the device remains in equilibrium. In addition, it is often desirable to verify C_{OX} , C_{MIN} , and R_{SERIES} . The following paragraphs discuss the procedures for characterizing these device parameters.

3.6.1 Device Characterization Menu

To characterize device parameters, select option 3, Compensate for Rseries and Determine Device Parameters on the Model 82-DOS main menu. The menu shown in Figure 3-13 will be displayed. By selecting appropriate options, you can perform the following:

1. Program measurement parameters as required.
2. Perform a diagnostic C-V sweep.
3. Graph the results of the diagnostics C-V sweep in order to check for proper accumulation and inversion voltages, as well as to verify device type.
4. Bias the device in accumulation to determine R_{SERIES} , C_{OX} , T_{OX} , and/or gate area.
5. Bias the device in inversion and determine C_{MIN} and equilibrium delay time.

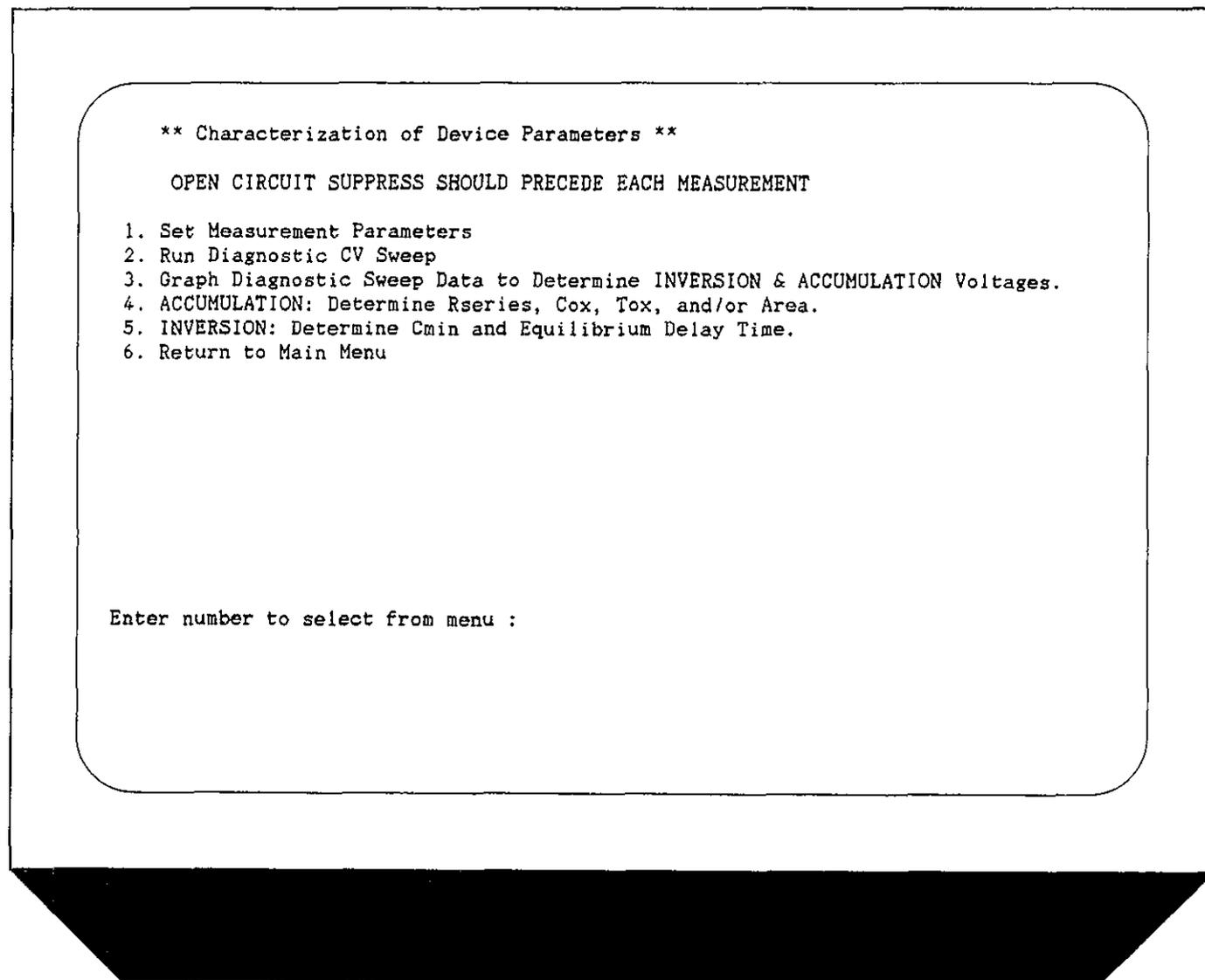

Figure 3-13. Device Characterization Menu

3.6.2 Running and Analyzing a Diagnostic C-V Sweep

Before testing for other device parameters, you should run a diagnostic sweep on the device to check to see that proper start and stop voltages have been programmed for the accumulation and inversion of the curve.

Procedure

1. Before running a sweep, verify connections and suppress if necessary, as outlined in paragraph 3.4.5.
2. Select menu option 1, Set Measurement Parameters, and program the following:

Range: 200pF or 2nF depending on expected capacitance

Frequency: 100kHz or 1MHz, as required.

Model: Parallel

Start V: As required to bias the device in accumulation.

Stop V: As required to bias the device in inversion

T delay: 0.07sec

Step V: 50mV

C-Cap: Off

Filter: On

When programming voltage parameters, remember that the voltage polarity is at the gate with respect to the substrate. Thus, to begin the sweep in inversion on an n-type material, Start V would be negative and Stop V would be positive.

3. Return to the characterization menu by pressing "E" then ENTER.
4. Select option 2, Run Diagnostic C-V Sweep, on the menu, then press "Z" to enable suppress if C_Q , C_H , or G offsets are >1% of anticipated measured values for the DUT you are testing.
5. Place the probes down on the contact points for the device to be tested and close the fixture shield.
6. Press "S" to initiate the sweep after Q/t settles to the system leakage level. You can abort the sweep, by pressing any key, if desired.

7. After you are prompted that the sweep is completed, press any key to return to the characterization menu.
8. Select option 3, Graph Diagnostic Sweep Data. See the discussion below for interpretation of the C-V graph and recommendations. Press ENTER to return to the menu.

Analyzing the Results

The high-frequency curve should be analyzed to ensure that the sweep voltage range is sufficient to bias the device well into both accumulation and inversion. Typical C-V curves are shown in Figure 3-14 and Figure 3-15. It may be necessary to re-program the Start V or the Stop V (or both) to bias the device properly. Re-run the sweep to verify that the new values are appropriate.

The curves can also be used to verify the type of material under test. As shown in Figure 3-14, an n-type material is biased in inversion when the gate voltage is substantially negative, while the device is in accumulation when the gate voltage is positive. Note that the high-frequency capacitance in inversion is much lower than the high-frequency capacitance in accumulation.

The same situation holds true for p-type curves (Figure 3-15) except the polarities are reversed. In this instance, inversion occurs for gate voltages much greater than zero, while the accumulation region occurs when the device is biased negative.

The oxide capacitance, C_{OX} , is simply the maximum high-frequency capacitance when the device is biased in accumulation. Its value can be taken directly from the C-V plot, or more accurate C_{OX} value can be determined using the procedure in the next paragraph.

The minimum high-frequency capacitance, C_{MN} , can also be determined from the graph, or its value can be determined more accurately using the procedure in paragraph 3.6.4.

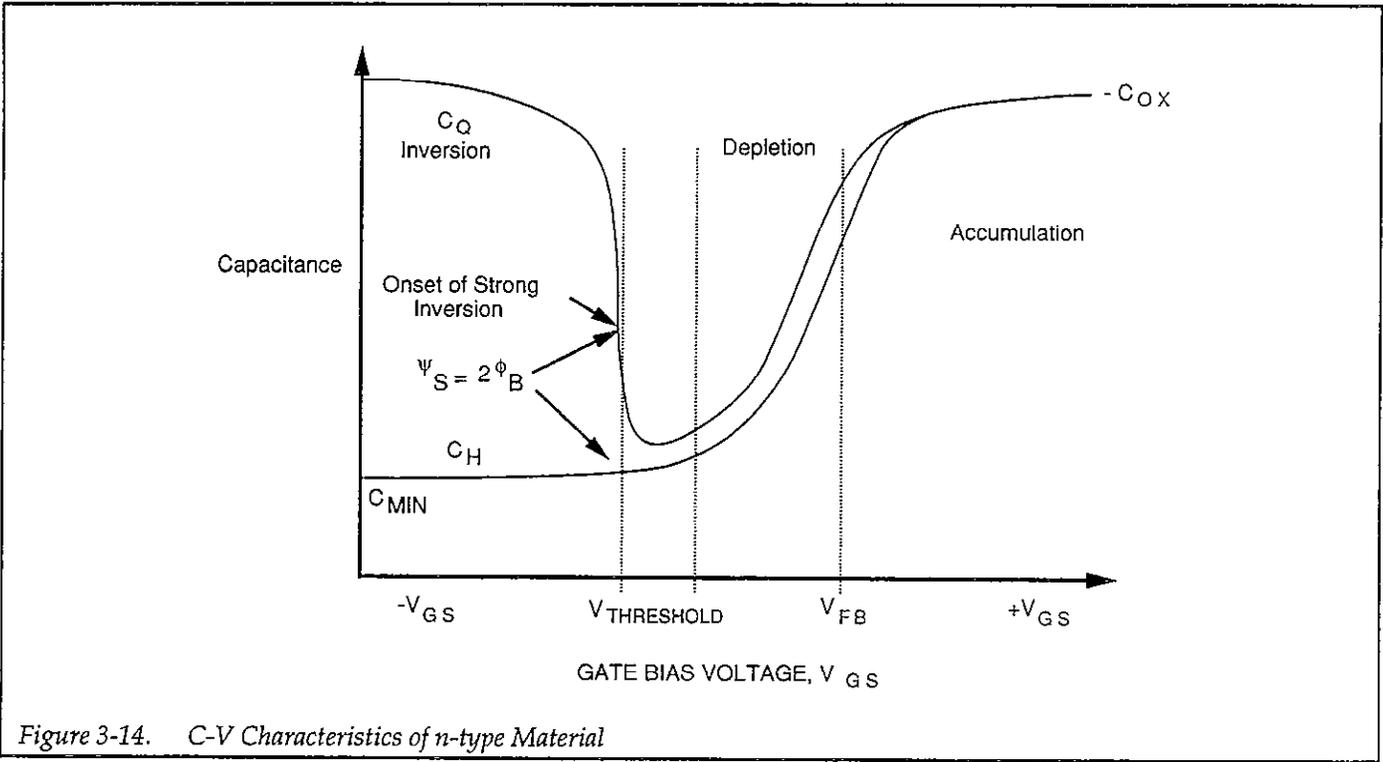

Figure 3-14. C-V Characteristics of n-type Material

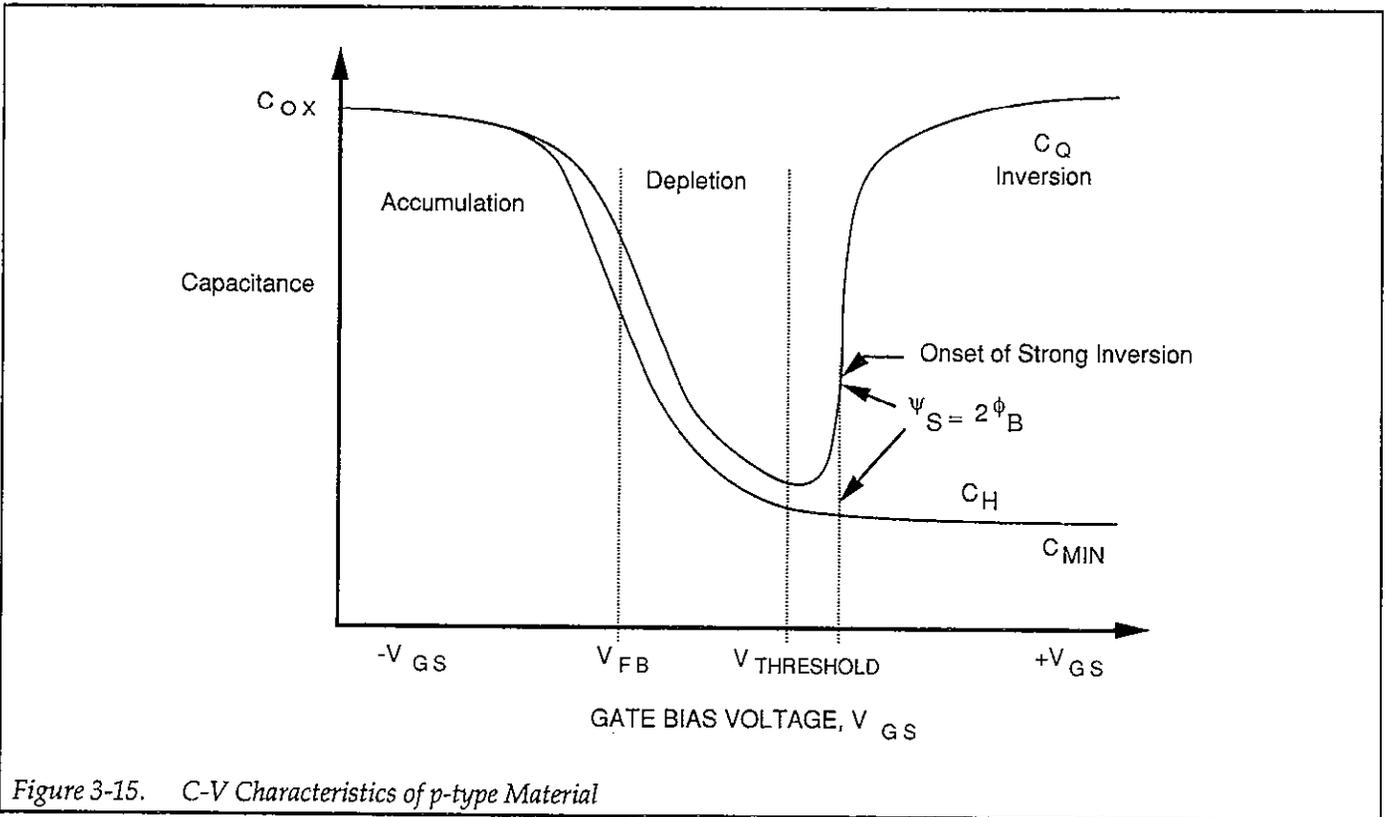

Figure 3-15. C-V Characteristics of p-type Material

3.6.3 Determining Series Resistance, Oxide Capacitance, Oxide Thickness, and Gate Area

Series Resistance

Devices with high series resistance such as those with epitaxial layers or with substrates with low doping can cause measurement and analysis errors unless steps are taken to compensate for this error term. Uncorrected series resistance can result in an erroneously low capacitance and a distorted G-V curve. (See Figure 4-8 and 4-9 for a comparison of uncompensated and compensated G-V curves.)

The Model 82-DOS software uses the three-element model described in paragraph 4.5.2 to compensate for series resistance. The series resistance, R_{SERIES} , is an analysis constant that can be entered as described below. The default value for R_{SERIES} is 0, which means that data will be unaffected if the value is not changed.

The Model 82-DOS software determines the displayed value of R_{SERIES} by converting parallel model data from the Model 590 into series model data. The resistance value corresponding to the maximum high-frequency capacitance in accumulation is defined as R_{SERIES} .

In conjunction with the added series resistance compensation, all displayed readings will be labelled as being either COMPENSATED or UNCOMPENSATED. Certain compensated readings are also compensated for gain and offset values (see below). Capacitance and conductance values used for analysis are also compensated for series resistance.

Oxide Capacitance, Oxide Thickness, and Gate Area

The oxide capacitance, C_{OX} , is determined by biasing the device in accumulation and noting the high-frequency capacitance, which is essentially the oxide capacitance, C_{OX} . Once C_{OX} is known, the oxide thickness (t_{OX}) or area (A) can be calculated. Note that these values are saved with the data and are used for analysis, as discussed in Section 4.

Procedure

1. Select option 4 on the Characterization of Device Parameters menu.
2. Press "M", and program the Bias V parameter necessary to bias the device in strong accumulation. Refer to the diagnostic curves made as outlined in paragraph 3.6.2 to determine optimum accumulation voltage. All other measurement parameters should remain the same as determined in paragraph 3.6.2.

NOTE

The Bias V value must be properly set to bias the device in strong accumulation in order to accurately determine both R_{SERIES} and C_{OX} .

3. Verify that the probes-up uncompensated capacitance is zero, and suppress by pressing "Z" if necessary.
4. Place the probes down on the device contact points, and close the test fixture shield.
5. Note the uncompensated high-frequency capacitance displayed on the computer screen, and verify that it is stable. A typical display, including compensated and uncompensated readings, is shown in Figure 3-16. Note that compensated readings take into account the effects of R_{SERIES} , gain, and offset.
6. To change R_{SERIES} , C_{OX} , t_{OX} , and/or gate area, press "C".
7. The recommended value of R_{SERIES} will be calculated and displayed.
8. Type in the recommended series resistance value, or enter your own value, if desired.
9. The recommended oxide capacitance value will be displayed. At this point, you can type in the recommended value for C_{OX} , or choose your own value, if desired.
10. You can now choose to enter oxide thickness or gate area. Enter the gate area in cm^2 , or enter the oxide thickness in nm. NOTE: To convert nm to \AA , multiply by a factor of 10. For example, $1\text{nm} = 10\text{\AA}$.
11. After these parameters are entered, updated R_{SERIES} , C_{OX} , t_{OX} , and gate area values will be displayed.
12. Press "Q" once data entry is complete to return to the previous menu.

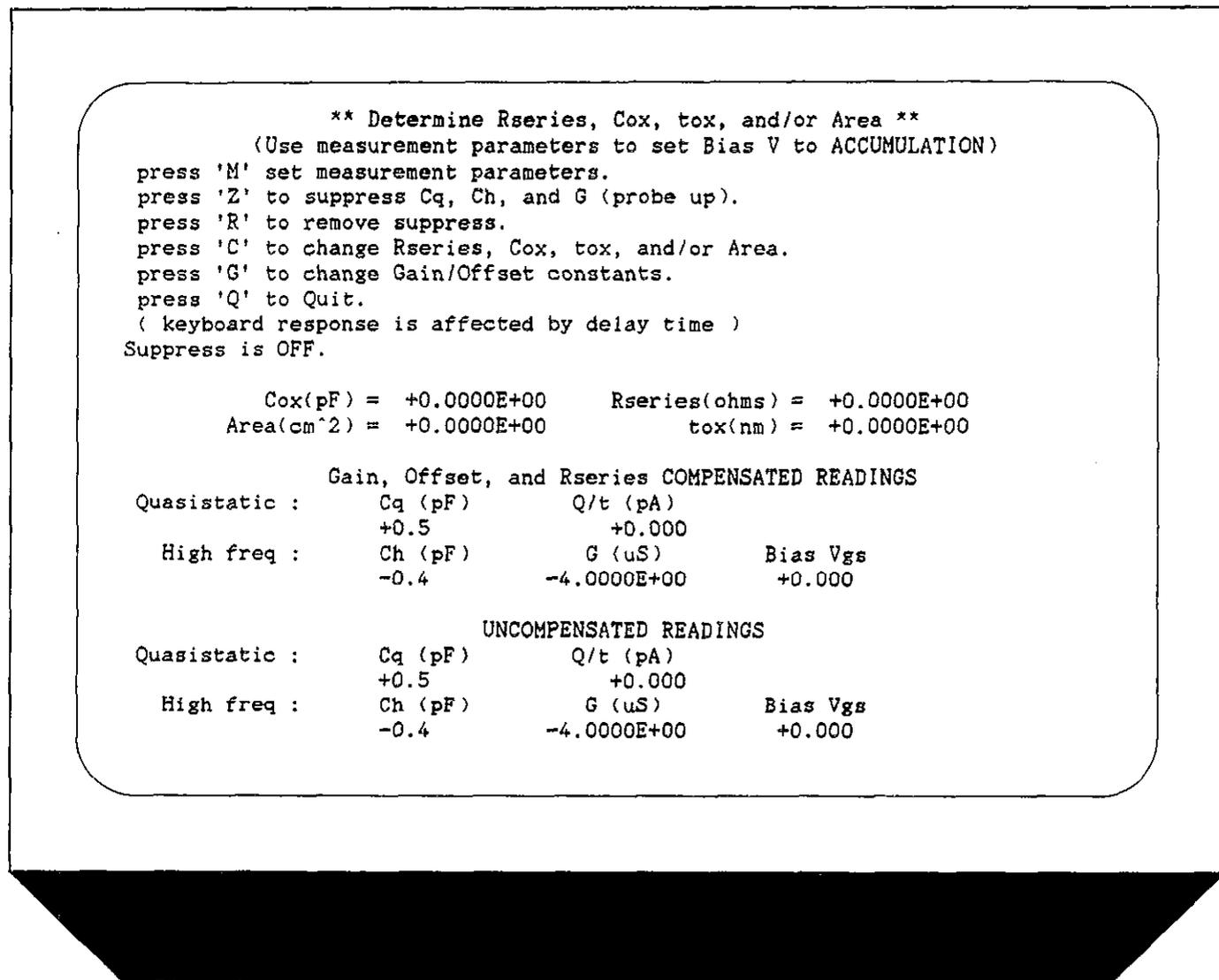

Figure 3-16. Series Resistance and Oxide Capacitance

Setting Gain and Offset Values

Separate gain and offset constants can be applied to both C_Q and C_H to aid in curve alignment or to compensate for measurement errors. Gain and offset constants are applied to capacitance values used for analysis and are also used to display compensated readings. Gain and offset constants can be changed as follows:

2. Press "G" to enter gain and offset constants.
3. Follow the prompts on the screen to enter desired C_Q and C_H gain and offset constants.

NOTE

To disable gain and offset, enter a value of 1 for gain, and enter a value of 0 for offset.

1. Select option 4 on the Characterization of Device Parameters menu.

4. Press "Q" to return to the previous menu.

3.6.4 Determining C_{MIN} and Optimum Delay Time

C_{MIN} Description

The minimum capacitance, C_{MIN} , is an analysis constant used to calculate the average doping concentration, N_{AVG} (paragraph 4.5.10). Basically, C_{MIN} is the high-frequency capacitance measured when the device is biased in strong inversion. The procedure to determine C_{MIN} is covered below.

Delay Time Description

For accurate measurements, the delay time must be carefully chosen to ensure that the device remains in equilibrium in the inversion region during a sweep. The procedure covered in this section discusses methods to find the optimum delay time from Q/t vs. V and C vs. V curves. A test fixture light can be controlled to speed up device equilibrium. Note that the total test time is about 25 times the maximum delay time, T_{MAX} .

Delay Time Filtering

Since the reading signal-to-noise ratio is proportional to the delay time, short delay time readings are filtered using an averaging algorithm in order to increase the signal-to-noise ratio of those readings. Averaging is related to the maximum delay time, T_{max} , as follows:

Delay Time	Number Readings Averaged
$0.01T_{max}$	100
$0.02T_{max}$	50
$0.04T_{max}$	25
$0.06T_{max}$	11
$0.08T_{max}$	6
$\geq 0.10T_{max}$	1

Delay Time Menu

Select option 5, Determine C_{MIN} and Equilibrium Delay Time. The computer will then display the menu shown in Figure 3-17. Through this menu, you can choose the following options.

1. Set Measurement parameters (M).
2. Suppress strays and leakages (Z).
3. Display "raw" readings (R).

4. Toggle light on or off (L). If your test fixture is equipped with a light to shine on the device, you can turn it on to reach the equilibrium point more rapidly. See paragraph 3.8 for information on connecting a light to the system.
5. Enter maximum delay time (D). Keep in mind that the plot will take about 25 times the maximum delay time to complete. For example, if you program a maximum delay time of 10 seconds, the plot will take about 250 seconds to complete.
6. Start measurement (S).
7. Graph data points (G) C_Q and Q/t vs. t_{DELAY} will be plotted by this option.
8. Print data points (P). After the measurement is completed, you can print out the data points on the printer by selecting this option.
9. View data points on CRT (V).
10. Enter C_{MIN} (C).
11. Quit (Q). Pressing "Q" returns you to the previous menu.

Procedure

1. Perform probes-up suppression, by pressing "Z".
2. Press "M", and program the following parameters.

Range: 200pF or 2nF, depending on expected capacitance.

Bias V: As required to bias device in strong inversion (Use value from diagnostic plot).

Step V: Set amplitude to be used when actually testing device (polarity is derived from Start V and Stop V).

C-Cap: Off except for leaky devices (see discussion below).

Filter: On.

3. Place the probes down on the device contact points and close the test fixture shield.
4. Press "D", and enter the desired maximum delay time. For an unknown device start with a time of 30-50sec for easiest interpretation.
5. If a light is connected to your system, press "L" to turn on the light to achieve equilibrium more rapidly. Note that the light status is indicated on the computer CRT.
6. Observe the Q/t readings on the computer CRT. Wait until the Q/t value is reduced to the system leakage level. At this point, the device has reached equilibrium.
7. If you are using a light, turn it off once equilibrium is reached before making the measurement by pressing "L". Again, the status of the light will be indicated on the computer CRT (it may take a few moments for the device to settle after the light is turned off).

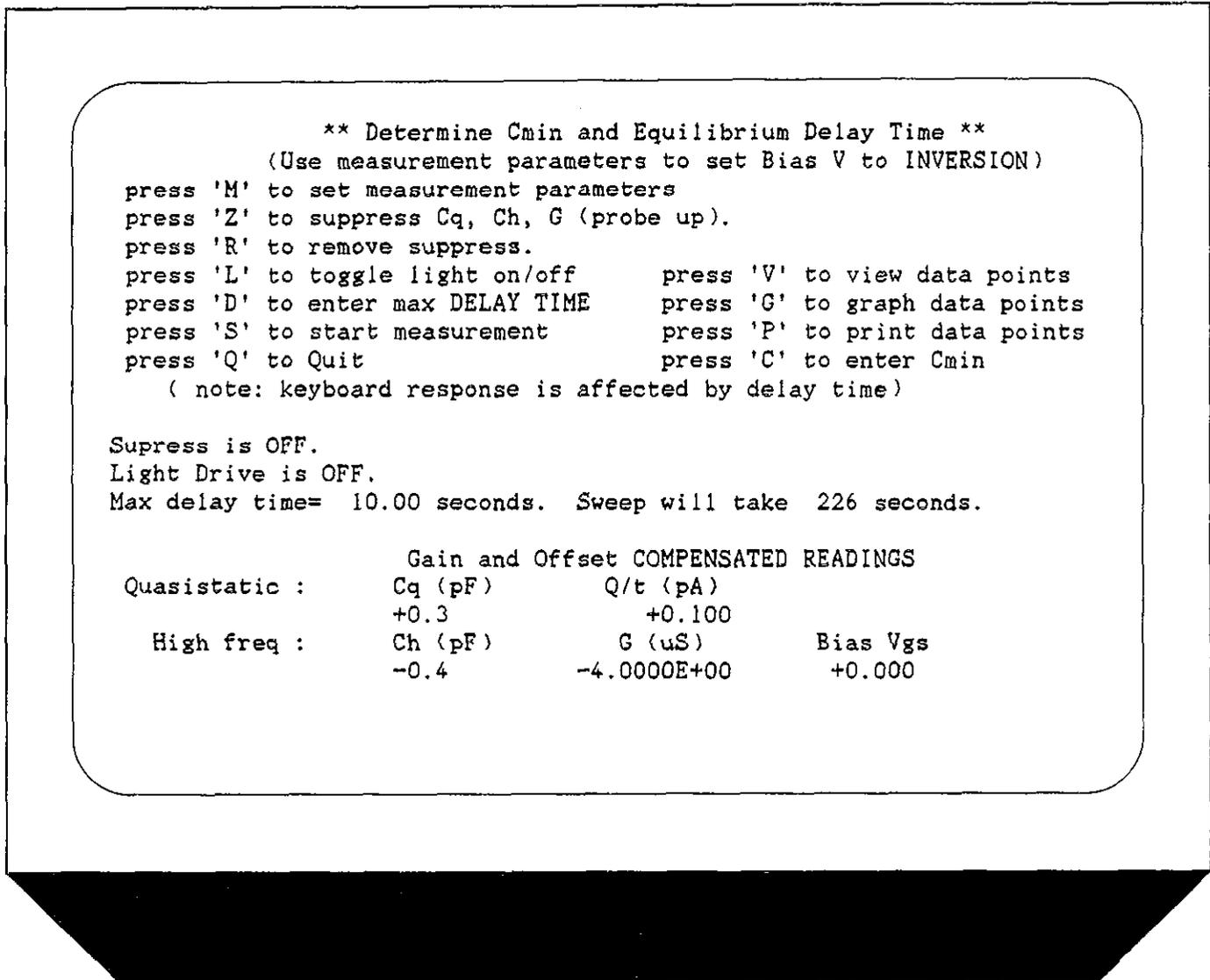

Figure 3-17. C_{MIN} and Delay Time Menu

8. Press "C" to enter C_{MIN}, which is the currently displayed high-frequency capacitance (C_H).
9. Press "S" to begin the delay time measurement. The computer will display the values of C_Q, Q/t, and t_{DELAY} on the CRT, up to a maximum of 11 points.
10. Once all points have been taken, press "G" to generate the Q/t and C_Q vs. t_{DELAY} graph, an example of which is shown in Figure 3-18. Note that both Q/t and C_Q will be automatically scaled along the Y axis of the graph.
11. Once the graph is completed, note both the Q/t and capacitance curves. The optimum delay time occurs when both curves flatten out to a slope of zero. For maximum accuracy, choose the second point on the curves after the curve in question has flattened out (see discussion below for additional considerations).
12. After choosing the optimum delay time, exit the graph submenu. You can now print out or view your data points on the printer by pressing "P" or "V" if desired.
13. Once the optimum delay time has been accurately determined, press "M", and program T Delay with the optimum delay time value determined by this procedure. Use this delay time when testing and measuring the device, as described in paragraph 3.7.

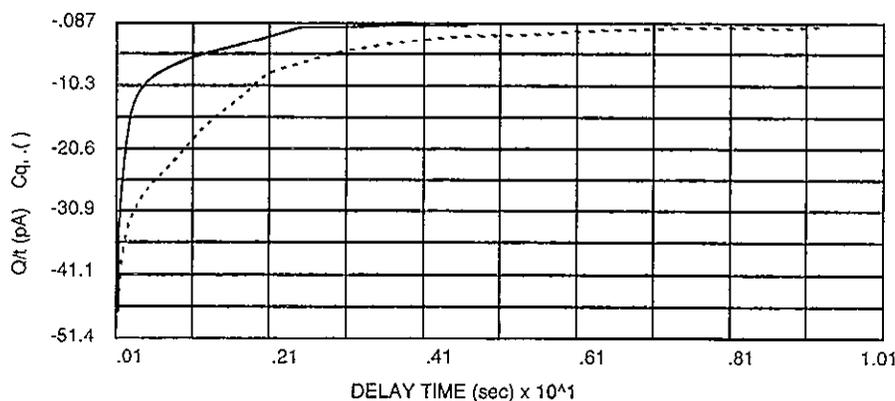

Figure 3-18. Q/t and C_Q vs. Delay Time Example

Analyzing the Results

For best accuracy, you should choose a delay time corresponding to the second point on the flat portion of both the capacitance and Q/t curves, as shown in Figure 3-19. Of course, for long delay times, the measurement process can become inordinately long with some devices. To speed up the test, you might be tempted to use a shorter delay time, one that results in a compromise between speed and accuracy. However, doing so is not recommended since it is difficult to quantify the amount of accuracy degradation in any given situation.

Determining Delay Time with Leaky Devices

When testing for delay time on devices with relatively large leakage currents, it is recommended that you use the corrected capacitance feature, which is designed to compensate for leakage currents. The reason for doing so is illustrated in Figure 3-20. When large leakage currents are present, the capacitance curve will not flatten out in equilibrium, but will instead either continue to rise (positive Q/t) or begin to decay (negative Q/t).

Using corrected capacitance results in the normal flat capacitance curve in equilibrium due to leakage compensa-

tion. Note, however, that the curve taken with corrected capacitance will be distorted in the non-equilibrium region, so data in that region should be considered to be invalid when using corrected capacitance.

NOTE

If it is necessary to use corrected capacitance when determining delay time, it is recommended that you make all measurements on that particular device using corrected capacitance (C-cap on). Return to the set parameters menu to turn on C-cap.

Testing Slow Devices

A decaying noise curve, such as the dotted line shown in Figure 3-19, will result if the maximum delay time is too short for the device being tested. This phenomenon, which is most prevalent with slow devices, occurs because the signal range is too small. To eliminate such erroneous curves, choose a longer maximum delay time. A good starting point for unknown devices is a 30-second maximum delay time, which would result in a five-minute test duration.

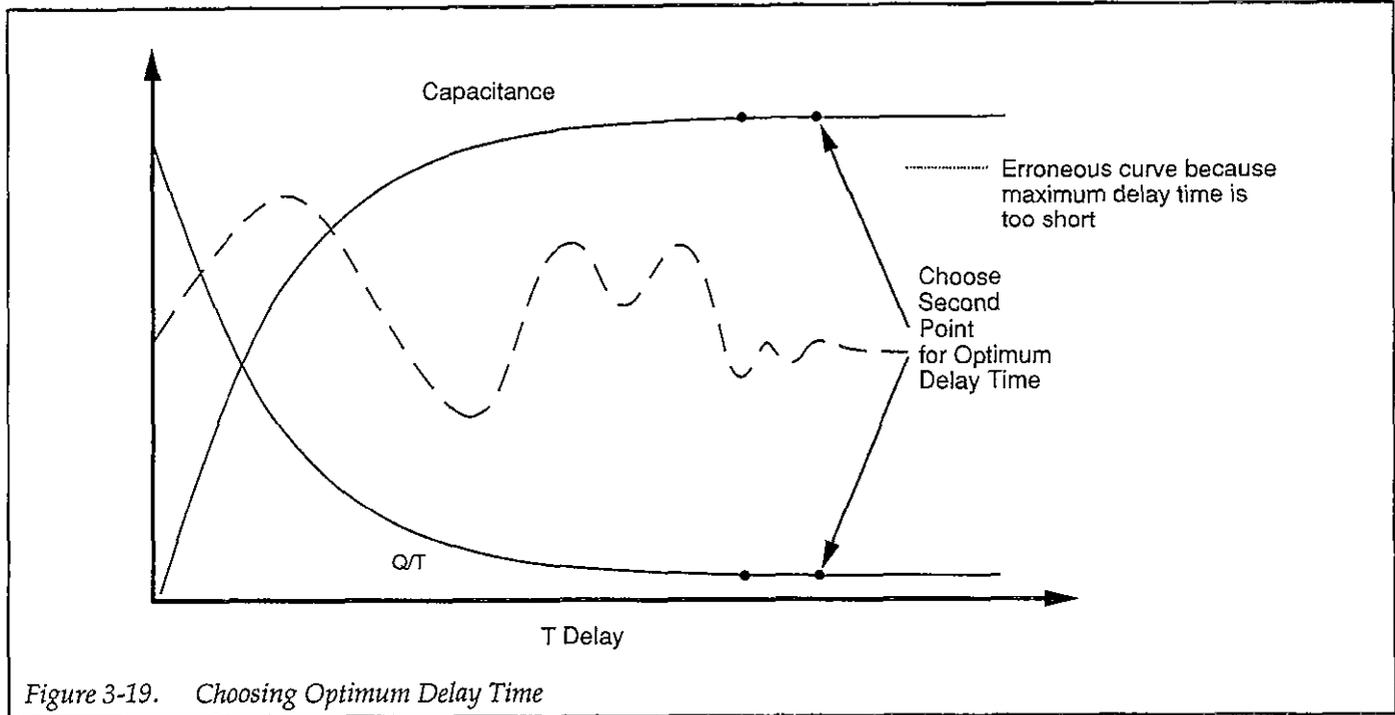

Figure 3-19. Choosing Optimum Delay Time

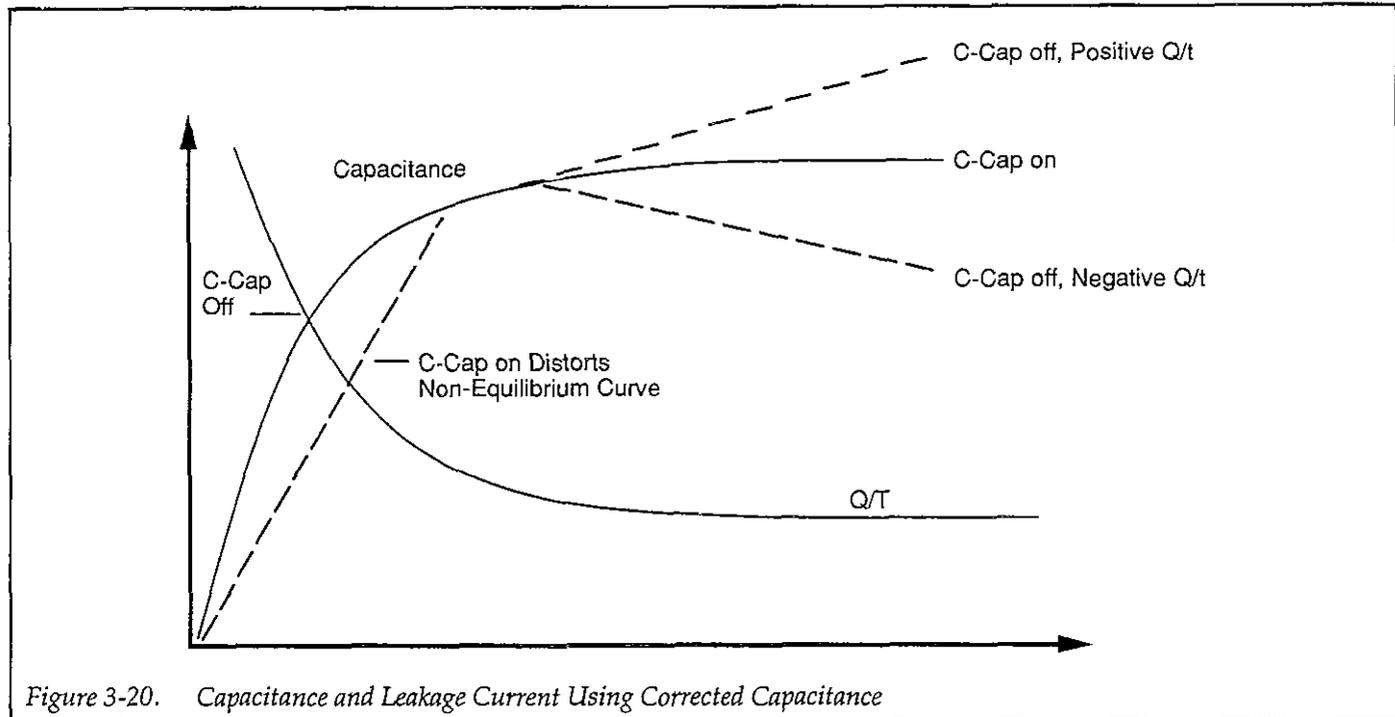

Figure 3-20. Capacitance and Leakage Current Using Corrected Capacitance

3.7 MAKING C-V MEASUREMENTS

The following paragraphs describe procedures for making C-V sweeps both manually, and automatically. During a sweep, the following parameters are stored within an array for later analysis:

1. C_Q (quasistatic capacitance). C_Q is measured by the Model 595.
2. Q/t (current), as measured by the Model 595.
3. C_H (high-frequency capacitance). High-frequency capacitance is measured at 100kHz or 1MHz (depending on the selected test frequency) by the Model 590.
4. G (high-frequency conductance). The Model 590 measures the conductance of the device at 100kHz or 1MHz, depending on the selected test frequency.

NOTE

When using series model, resistance will be stored and displayed instead of conductance.

5. V_{GS} (gate voltage). The gate voltage is measured by the Model 590. Note that the gate voltage as it is used by the computer is opposite in polarity from that displayed on the front panel of the Model 590 because of the gate-to-substrate voltage convention used (gate terminal connected to INPUT; substrate terminal connected to OUTPUT).

3.7.1 C-V Measurement Menu

Figure 3-21 shows the menu for C-V measurements. Various options on this menu allow you to program menu parameters, manually start a C-V sweep, automatically initiate the sweep, and access the analysis functions. These options are discussed below.

3.7.2 Programming Measurement Parameters

Menu Selections

By selecting option 1 on the C-V measurement menu, you can access the parameter selection menu shown in Figure 3-22. (Parameters can also be set from the sweep menu by pressing "M".) This menu allows you to program the following parameters:

1. Range for both quasistatic and high-frequency measurements (200pF or 2nF). The measurement ranges of both the Models 590 and 595 are set by this parameter.
2. Frequency for high-frequency measurements (100kHz or 1MHz). This parameter sets the operating frequency of the Models 590 and 595.
3. Model (parallel or series). Model selects whether the device is modeled as a parallel capacitance and conductance, or a series capacitance and resistance. Model affects only high-frequency capacitance and conductance measurements. See paragraph 3.9.6 for a discussion of series and parallel model.
4. Start V: ($-120 \leq V \leq 120$). Start V is the initial bias voltage setting of a C-V sweep.
5. Stop V: ($-120 \leq V \leq 120$). Stop V is the final bias voltage setting of a C-V sweep.
6. Bias V: Bias V is a static DC level applied to the device during certain static monitoring functions such as leakage level tests and determining device C_{ox} and delay time. Note that the voltage source value returns to the Bias V level after Stop V at the end of the sweep.
7. T delay: ($0.07 \leq T \leq 199.99$ sec). Note that the time delay must be properly programmed to maintain device equilibrium during a sweep, as discussed in paragraph 3.6.
8. Step V: (10mV, 20mV, 50mV or 100mV): Step V is the incremental change of voltage of the bias staircase waveform. The polarity of Step V is automatically set depending on the relative values of Start V and Stop V. If Stop V is more positive than Start V, Step V is positive; if Stop V is more negative than Start V, Step V is negative.
9. C-Cap: (Corrected capacitance). Uses the corrected capacitance program of the Model 595 when enabled. C-Cap should be used only when testing leaky devices. As discussed in paragraph 3.6, C-cap should be used for device measurement if you found it necessary to use C-cap when determining delay time.
10. Filter: Sets the Model 595 to Filter 2 when on, Filter 0 (off) when off. The Model 590 filter is always enabled.

NOTE

The filter may distort the quasistatic C-V curve if there are less than 50 readings in the depletion region of the curve. Turning off the filter will increase reading noise by 2.5 times. See the Model 595 Instruction Manual for complete filter details.

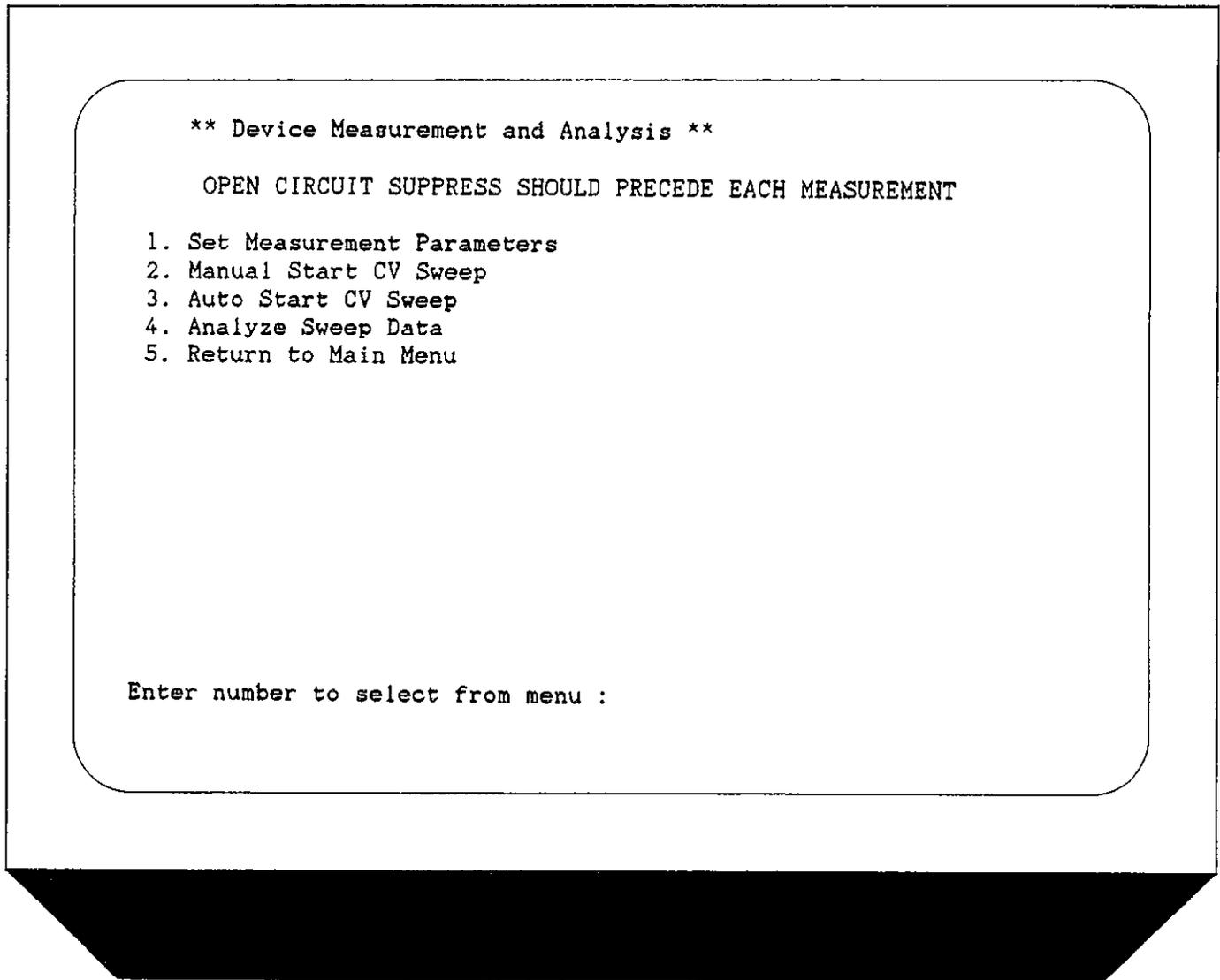

Figure 3-21. Device Measurement and Analysis Menu

** Measurement Parameter List **

Range: 2 Enter R1 for 200pF, R2 for 2nF
Freq : 2 Enter F1 for 100KHZ, F2 for 1MHZ
Model: 1 Enter M1 for parallel, M2 for series
Start V: 2.00 V. Enter An, -120 <= n <= 120
Stop V: -2.00 V. Enter On, -120 <= n <= 120
Bias V: 0.00 V. Enter Bn, -120 <= n <= 120
TDelay: 0.07 sec. Enter Tn, 0.07 <= n <= 199.99
Step V: 20 mV. Enter S10, S20, S50 or S100
CCap: 1 Enter C1 for leakage correction off, C2 for on
Filter: 2 Enter I1 for filter off, I2 for on

Number of samples = 93 Sweep will take = 0.4 minutes.

- NOTE: 1) Keep start V and stop V within 40 volts of each other.
 2) Keep number of samples within 4 and 1000 points with filter off.
 3) Keep number of samples within 50 and 1000 points with filter on.

Enter changes one change at a time. Enter E when done, * for files.

Enter selection :

Figure 3-22. Parameter Selection Menu

Determining the Number of Readings in a Sweep

The number of readings (bias step) in a given sweep is determined by Start V, Stop V, and Step V, as well as whether or not the filter is enabled. The number of readings is determined as follows:

$$R = \text{INT} [(ABS(V_{\text{STOP}} - V_{\text{START}}) / 2V_{\text{STEP}}) - F]$$

Where: R = number of readings in the sweep
INT = take the integer of the expression
ABS = take the absolute value of the expression
V_{STOP} = programmed stop voltage
V_{START} = programmed start voltage
V_{STEP} = programmed step voltage
F = 2 if the filter is off
F = 6 if the filter is on

Example: Assume that Start V and Stop V are +10V and -10V respectively, and that Step V is 100mV. With the filter on, the number of readings is:

$$R = \text{INT} [(ABS(-10-10)/.2) - 6]$$
$$R = 94$$

Sweep Duration Display

The sweep duration will be displayed on the measurement parameters menu. The sweep duration depends on the number of samples and the delay time.

Programming Parameters

To program a parameter, type in the indicated menu letter followed by the pertinent parameter. The examples below will help to demonstrate this process.

Example 1: Select 1MHz High-frequency Operation

To select high frequency operation, simply type in F2 at the command prompt and press the ENTER key.

Example 2: Program a +15V Bias V

Type in B15 and press the ENTER key.

Example 3: Select 0.1sec Delay Time

Type in T0.1 and press the ENTER key.

Example 4: Program a 20mV Step Voltage

Type in S20 and press the ENTER key.

Programming Considerations

When selecting parameters, there are a few points to keep in mind, including:

1. The maximum difference between the programmed Start V and Stop V is 40V. Exceeding this value will generate an error message.
2. Voltage source polarity is specified at the gate with respect to the substrate. For example, with a positive voltage, the gate will be biased positive relative to the substrate. Thus, an n-type material must be biased positive to be in the accumulation region.
3. Time delay must be carefully chosen so that the device remains in equilibrium throughout the sweep. The procedure to determine optimum delay time is covered in paragraph 3.6. Failure to program proper delay time will distort quasistatic and high-frequency C-V curves. See paragraph 3.9 for additional measurement considerations.
4. The filter should be used only when more than 50 readings in the fundamental change area of the curve are taken; see the Model 595 Instruction Manual, paragraph 3.12 for more information. Note that the parameter menu includes a note to remind you of the 50-reading limitation because you will not be able to exit the parameter menu with the filter on and <50 points.

Saving/Recalling Parameters

By pressing the "*" key, you can save or load parameters to or from diskette. Press "S" (save) or "L" (load) to carry out the desired operation. You will then be prompted to type in the filename to be saved or loaded. An error message will be given if a file cannot be found or will be overwritten. Do not include the .PAR extension when specifying the filename.

When the save option is selected, the parameter values currently in effect will be saved under the selected filename. Parameters loaded from an existing file will be updated to conform to the new values.

NOTES

1. You can automatically load a parameter file and start the program at the measurement menu by including the parameter filename with the program run command. See paragraph 2.4.9.
2. To save or load a parameter file in a directory other than the default directory, include the complete path in the filename (for example, A: MYFILE or C:\TESTS\MYFILE).

Returning to Previous Menu

After all parameters have been programmed (or loaded from disk), press "E" to return to the previous menu.

3.7.3 Selecting Optimum C-V Measurement Parameters

When programming C-V measurement parameters, keep the following points in mind. Refer to paragraph 3.9 for a more complete discussion of these and other considerations.

Choosing Optimum Start and Stop Voltages

Most C-V data is derived from the steep transition, or depletion region of the C-V curve (see Figures 3-14 and 3-15). For that reason, start and stop voltages should be chosen so that the depletion region makes up about 1/3 to 2/3 of the voltage range.

The upper flat, or accumulation region of the high-frequency C-V curve defines the oxide capacitance, C_{OX} . Since most analysis relies on the ratio C/C_{OX} , it is important that you choose a start or stop voltage (depending on the sweep direction) to bias the device into strong accumulation at the start or end of the sweep.

See paragraph 3.6.3 for the procedure to determine C_{OX} .

Selecting the Number of Data Points

The relative values of the start, stop, and step voltages determines the number of data points in the sweep. When choosing these parameters, some compromise is in order

between having too few data points in one situation, or too many data points in the other.

The complete doping profile is derived from data taken in the depletion region of the curve by using a derivative calculation. As the data point spacing decreases, the vertical point scaling is increasingly caused by noise rather than changes in the desired signal. Consequently, choosing too many points in the sweep will result in increased noise rather than an increased resolution in measurement of the C-V waveform.

To minimize noise, choose parameters that will yield a capacitance change of approximately ten times the percentage error in the signal. For Model 82-DOS, the optimum step size is about 5-10% change in capacitance value per step.

Sweep Direction

For high-frequency C-V sweeps only, you can sweep either from accumulation to inversion, or from inversion to accumulation. Sweeping from accumulation to inversion will allow you to achieve deep depletion—profiling deeper into the semiconductor than you otherwise would obtain by maintaining equilibrium. When sweeping from inversion to accumulation, you should use a light pulse to achieve equilibrium before the sweep begins.

3.7.4 Manual C-V Sweep

Description

A manual C-V sweep requires that you observe device leakage, and then manually trigger the sweep. When sweeping from inversion to accumulation, you should wait for the device to attain equilibrium. An optional light can be controlled to speed up the equilibrium process.

Procedure

1. Select the Manual Start C-V Sweep Option. The computer will display the options in Figure 3-23. Note that displayed readings are compensated for gain, offset, and series resistance.
2. Verify a zero probes-up capacitance, and suppress if necessary (press "Z").

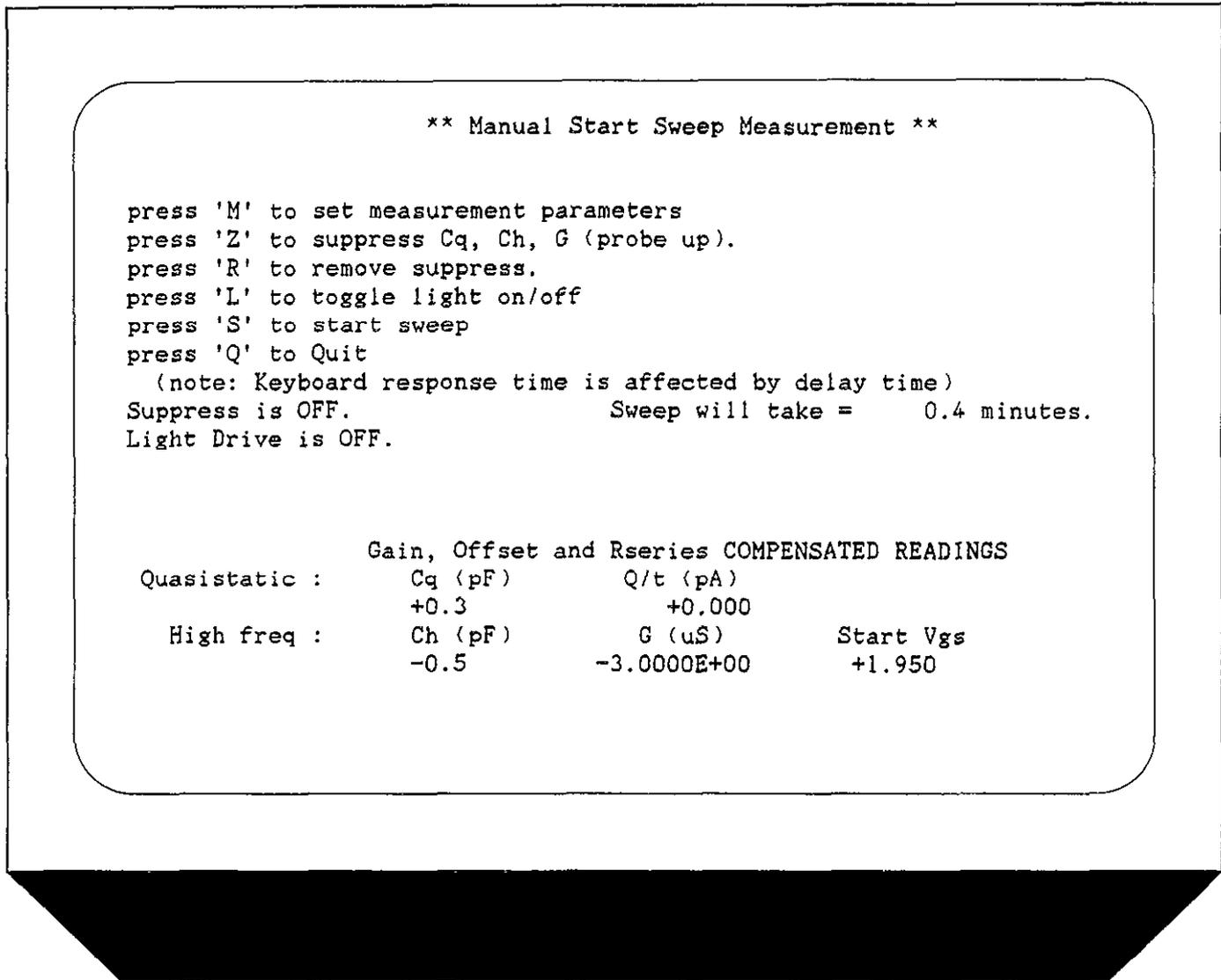

Figure 3-23. Manual Sweep Menu

3. Press "M" and program the following parameters.

Range: As required for the expected capacitance.

Frequency: 100kHz or 1MHz as required.

Model: Parallel or series as required.

Start V: Accumulation or inversion voltage, as determined in paragraph 3.6.

Stop V: Inversion or accumulation voltage, as determined in paragraph 3.6.

T Delay: As required to maintain equilibrium (See paragraph 3.6)

Step V: Same as used when testing device in paragraph 3.6.

C-Cap: Off except for leaky devices (see paragraph 3.6).

Filter: On

4. If sweeping from accumulation to inversion, monitor the current until it reaches the system leakage level, as discussed in paragraph 3.4. When the current reaches the system leakage level, press "S" to trigger the sweep.

5. If sweeping from inversion to accumulation, wait until the device reaches equilibrium (equilibrium occurs when Q/t decays to the system leakage level). If a light is connected to the system, press "L" to turn on the light to speed up equilibrium. Turn off the light once equilibrium is reached prior to initiating the sweep (it may take a few moments for the device to settle after turning off the light). Press "S" to initiate the sweep.
6. The computer will then display a message that the sweep is in progress. During the sweep, you can press any key to abort, if desired.
7. Following the sweep, press any key to return to the previous menu.
8. Select option 4 to view and analyze the data. Refer to Section 4 for complete details on data analysis. Note that C_{ox} , area, and N_{BULK} values, as previously used in analysis may not apply to this measurement, and may require changing before analysis.

3.7.5 Auto C-V Sweep

Description

The auto sweep procedure is similar to that used for manual sweep, except that you can program the current trip point at which the sweep will automatically begin. Otherwise, the procedure is essentially the same, as outlined below.

Procedure

1. Select Auto Start C-V Sweep. The computer will display the options in Figure 3-24. Note that displayed readings are compensated for gain, offset, and series resistance.
2. Verify a zero probes-up capacitance and suppress if necessary, (press "Z").
3. Press "M" and program the following parameters.

Range: As required for the expected capacitance.

Frequency: 100kHz or 1MHz as required.

Model: Parallel or series as required.

Start V: Accumulation or inversion voltage, as determined in paragraph 3.6.

Stop V: Inversion or accumulation voltage, as determined in paragraph 3.6.

T Delay: As required to maintain equilibrium (See paragraph 3.6)

Step V: Same as used when testing device in paragraph 3.6.

C-Cap: Off except for leaky devices.

Filter: On

4. Press "G" and the type in the desired leakage trip point when prompted to do so. Typically, this value will equal the system leakage level, as determined in paragraph 3.4.
5. Press "T" to select above or below trip threshold.
6. If sweeping from inversion to accumulation, you can turn on the light (if so equipped) to speed up equilibrium by pressing "L". Be sure to turn off the light once equilibrium is reached before initiating the sweep (it may take a few moments for the device to settle after turning off the light).
7. Press "A" to arm the sweep. The computer will continue to monitor readings while waiting for the trip point.
8. Once the leakage current reaches the trip point, the sweep will be initiated automatically. During the sweep, you can press any key to abort the process.
9. Once the sweep is completed, press any key to return to the previous menu.
10. Select option 4, Analyze C-V Data, to view or graph the data. Section 4 covers analysis in detail.

3.7.6 Using Corrected Capacitance

When making quasistatic measurements on leaky devices, it is recommended that you use the corrected capacitance function to compensate for leakage. Otherwise, the resulting quasistatic C-V curves will be tilted because of the leakage resistance of the device or test system. When using corrected capacitance, it is very important that the device remain in equilibrium throughout the sweep. Data taken in non-equilibrium with corrected capacitance enabled should be considered to be invalid, and the resulting curve will be distorted in the non-equilibrium region of the curve.

NOTE

If you found it necessary to use corrected capacitance when determining delay time (paragraph 3.6), it is recommended that you also use corrected capacitance when measuring the device.

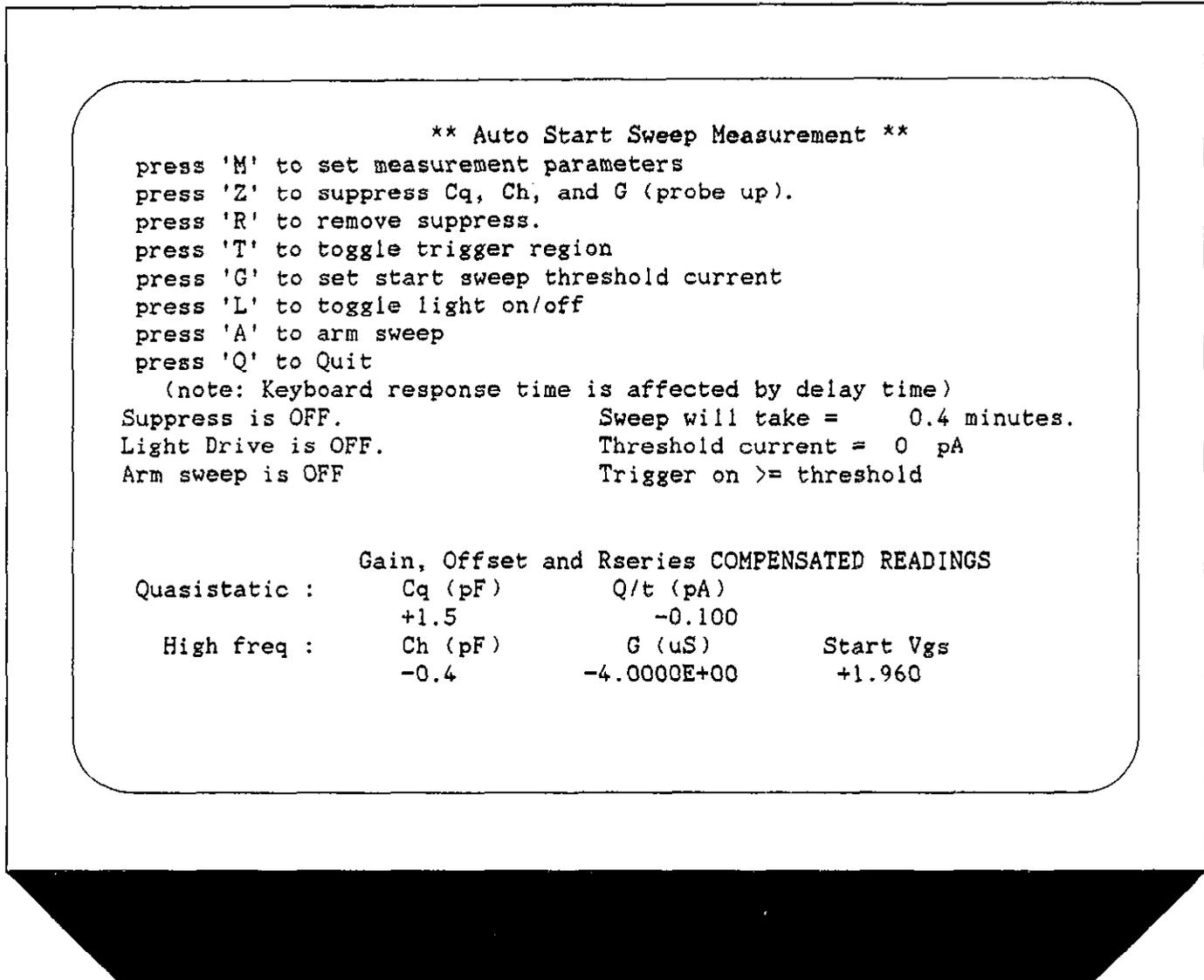

Figure 3-24. Auto Sweep Menu

3.8 LIGHT CONNECTIONS

A user-supplied light can be connected to the system in order to help attain device equilibrium in inversion more rapidly. This light is controlled through appropriate terminals on the DIGITAL I/O port of the Model 5951 Remote Input Coupler. The following paragraphs discuss DIGITAL I/O port terminal assignments along with typical light connections.

3.8.1 Digital I/O Port Terminals

Table 3-2 summarizes the terminal assignments for the DIGITAL I/O port of the Model 5951. Figure 3-25 shows the pinouts for the supplied mating connector. Terminals include:

Table 3-2. Digital I/O Port Terminal Assignments

Terminal	Description
1	+5V Digital*
2	+5V Digital*
3	Digital Input 1**
4	Digital Input 2**
5	Digital Input 3**
6	Digital Input 4**
7	NC
8	NC
9	NC
10	Output***
11	Digital Common
12	Digital Common

*+5V source through internal 33Ω resistor.
 **Digital inputs passed through to Model 230-1
 ***Output controls light: HI=OFF; LO=ON

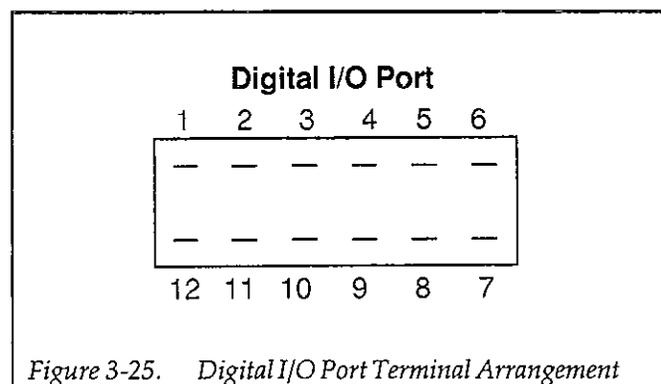

Figure 3-25. Digital I/O Port Terminal Arrangement

+5V Digital (pins 1 and 2): +5V digital is supplied through an internal 33Ω resistor for short-circuit protection. Current draw should be limited to 20mA to avoid supply loading.

Digital Inputs (pins 3-6): These terminals pass through the digital inputs to the Model 230-1. One possible use for these inputs would be to monitor a test fixture closure status switch. Note that the Model 82-DOS software does not presently support reading the input terminals, but it could be modified to do so, if desired. The status of these inputs can be read with the U1 command, as described in the Model 230 Programming Manual.

OUTPUT: OUTPUT is intended for controlling an external light source. Logic convention is such that OUTPUT is LO when the software indicates that the light is ON. Note that OUTPUT is LS-TTL compatible with a guaranteed 8mA current sink capability.

Digital Common: Provides a common connection for external circuits.

3.8.2 LED Connections

The digital output has sufficient drive capability to directly drive LEDs up to 8mA using the connecting method shown in Figure 3-26. The anode of the LED should be connected to +5V, and the cathode should be connected to OUTPUT through a 330Ω current-limiting resistor. Use of LEDs that draw more than 8mA is not recommended.

3.8.3 Relay Control

For larger LEDs, or for small incandescent lamps, an external relay control circuit can be used to switch the larger current. Figure 3-27 shows a typical circuit. With the configuration shown, a normally closed relay contact will be necessary to ensure the light is on at the proper time. Note that an external power supply will be necessary to drive the external circuitry. The value of the base resistor will depend on the current gain of the transistor as well as the power supply voltage and relay coil resistance. For example, with a supply voltage of 5V, a coil resistance of 500Ω, and a current gain of 100, a base resistor value of 10kΩ should be adequate to drive the transistor into saturation.

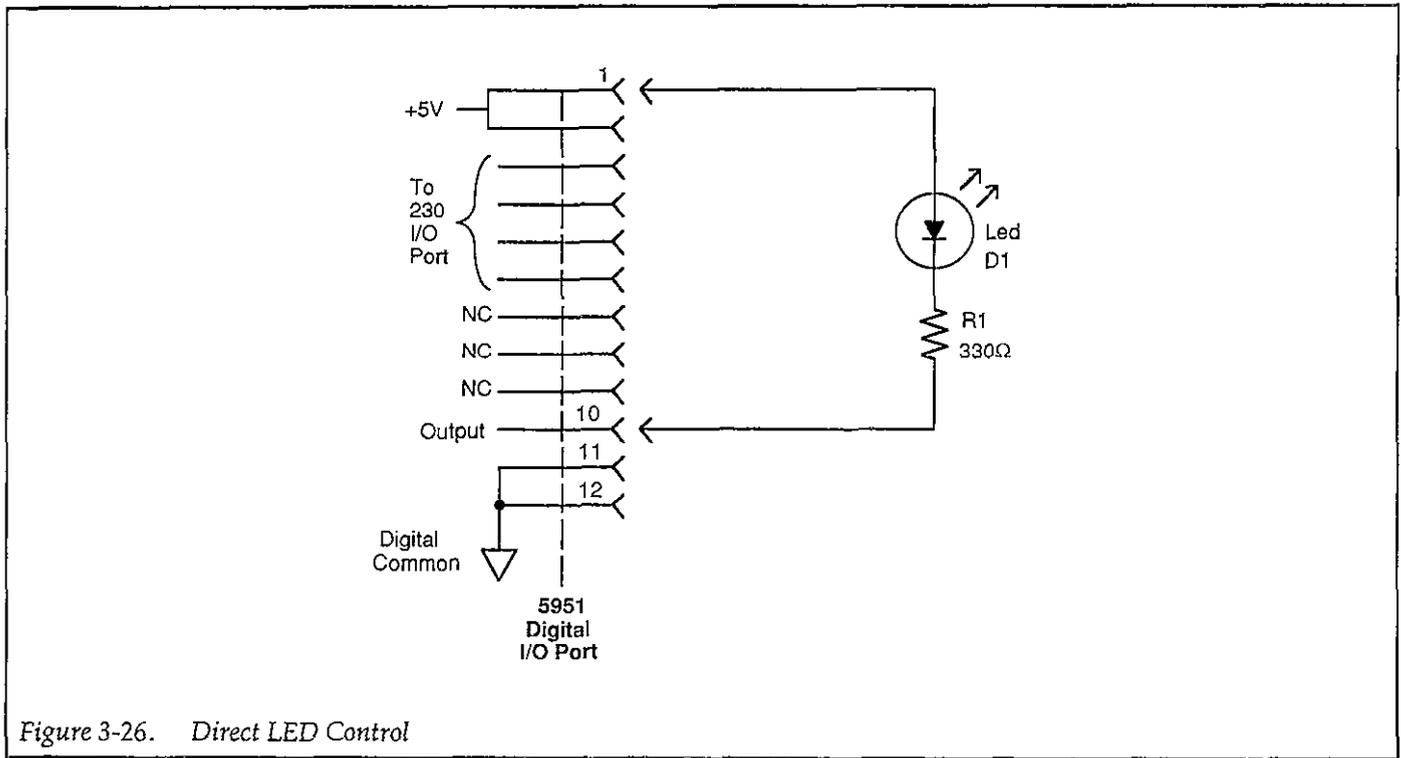

Figure 3-26. Direct LED Control

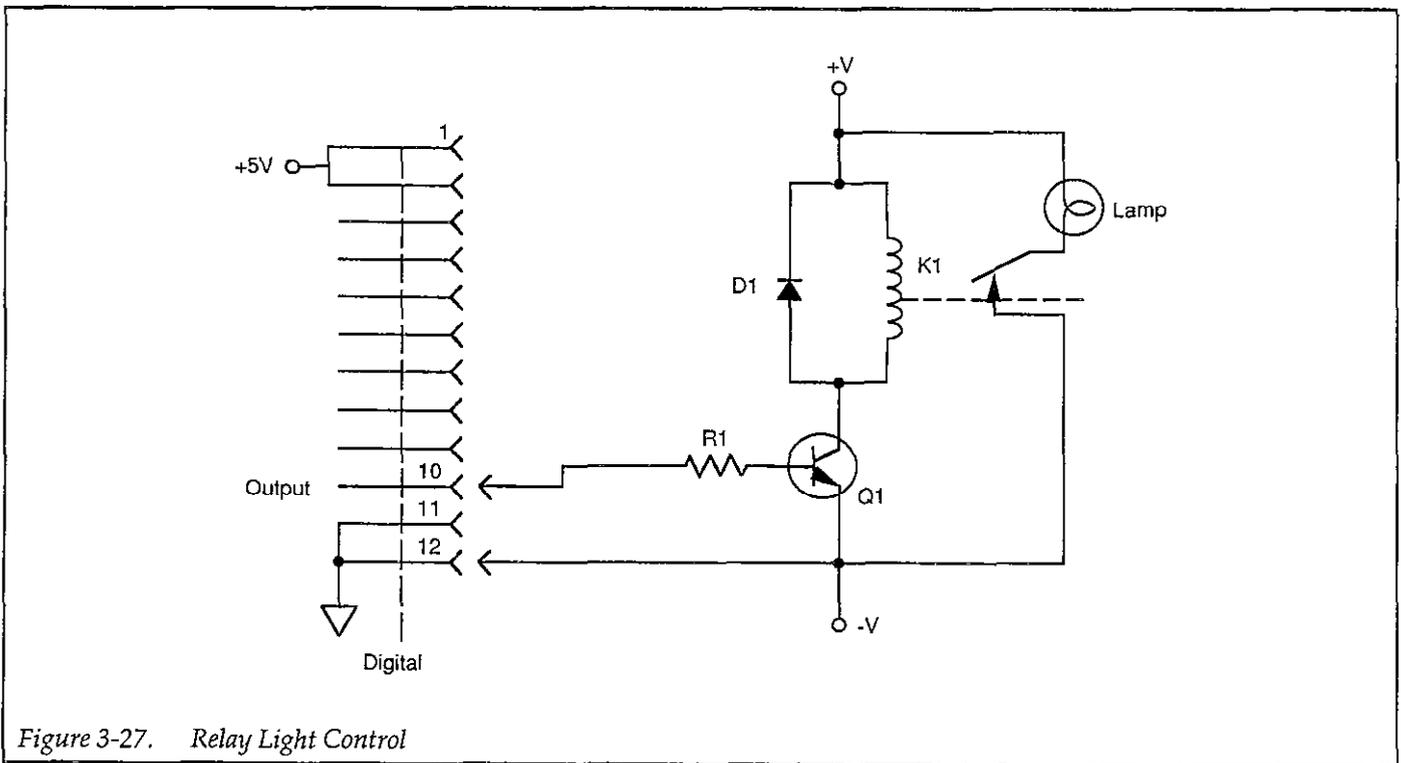

Figure 3-27. Relay Light Control

3.9 MEASUREMENT CONSIDERATIONS

The importance of making careful C-V curve measurements is often underestimated. However, errors in the C-V data will propagate through calculations, resulting in errors in device parameters derived from the curves. These errors can be amplified during calculations by a factor of 10 or more.

With careful attention, the effects of many common error sources can be minimized. In the following paragraphs, we will discuss some common error sources and provide suggested methods for avoiding them.

3.9.1 Potential Error Sources

Theoretically, a capacitance measurement using one of the common techniques would require only that two leads be used to connect the measuring instrument to the device under test (DUT)---the input and output. In practice, however, various parasitic or stray components complicate the measuring circuit.

Stray Capacitances

Regardless of the measurement frequency, stray capacitances present in the circuit are important to consider. Stray capacitances can cause offsets when they are in parallel with the device, can act as a shunt load on the input or output, or can cause coupling between the device and nearby AC signal sources.

When stray capacitance is in parallel with the DUT, it causes a capacitance offset, adding to the capacitance of the device under test (C_{DUT}), as shown in Figure 3-28. Shunt capacitance, on the other hand, often increases the noise gain of the instrumentation amplifiers, increasing capacitance reading noise (Figure 3-29). Shunt capacitance also forms a capacitive divider with C_{DUT} , steering current away from the input to ground. This phenomenon results in capacitance gain error, with the C-V curve results shown in Figure 3-30.

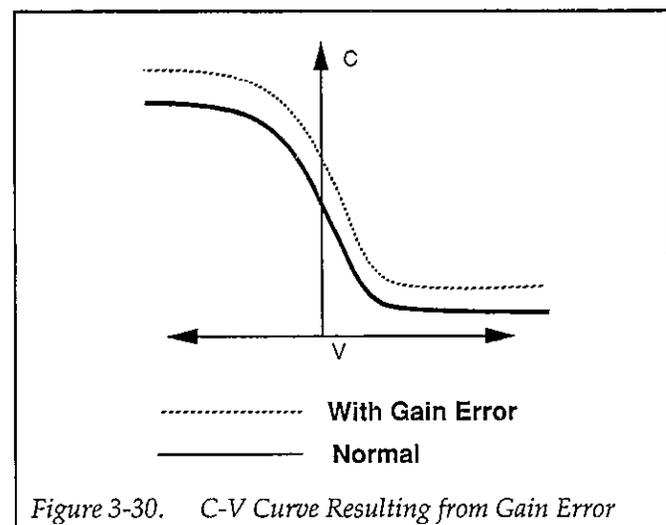
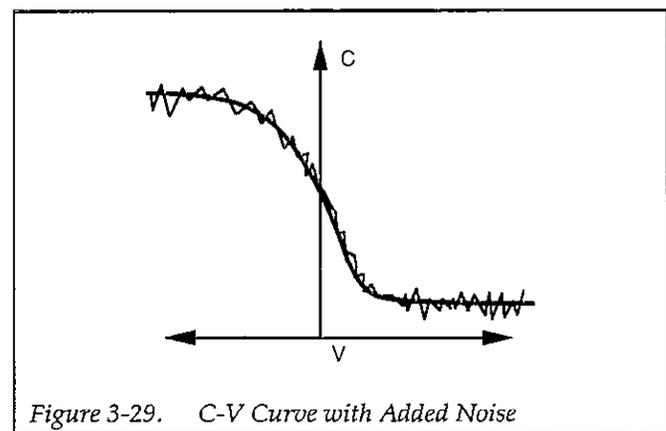
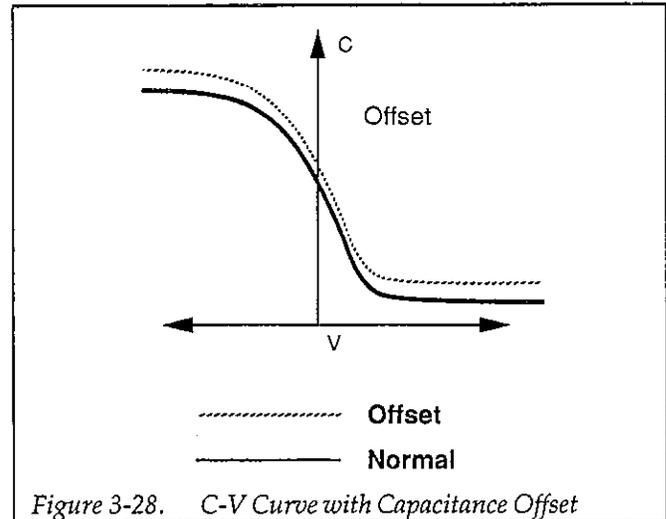

Stray capacitance may also couple current of charge from nearby AC signal sources into the input of the measuring instrument. This noise current adds to the device current and results in noisy, or unrepeatable measurements. For quasistatic measurements, power line frequency and electrostatic coupling are particularly troublesome, while digital and RF signals are the primary cause of noise induced in high-frequency measurements.

Leakage Resistances

Under quasistatic measurement conditions, the impedance of C_{DUT} is almost as large as the insulation resistance in the rest of the measurement circuit. Consequently, even leakage resistances of $10^{12}\Omega$ or more can contribute significant errors if not taken into consideration.

Resistance across the DUT will conduct an error current in addition to the device current. Since this resistive current is directly proportional to the applied bias voltage, and the capacitor current is not, the result is a capacitance offset that is proportional to the applied voltage. The end result shows up as a "tilt" in the quasistatic C-V curve, as shown in Figure 3-31.

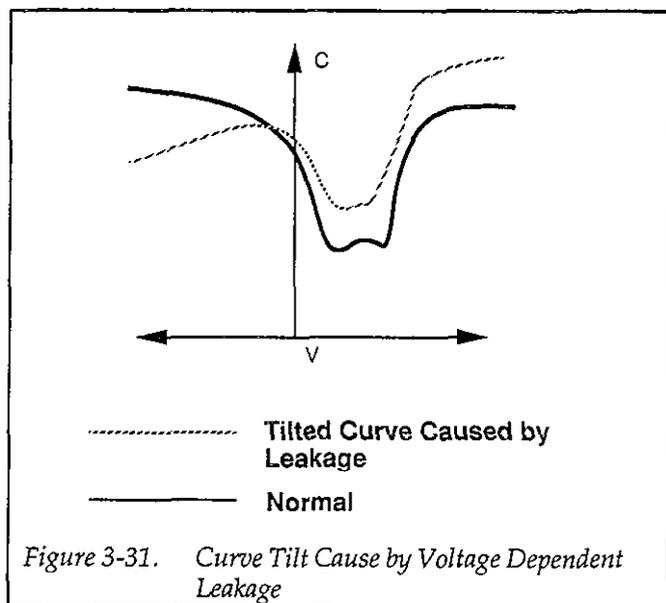

Stray resistance to nearby fixed voltage sources results in a constant (rather than a bias voltage-dependent) leakage current. Other sources of constant leakage currents include instrument input bias currents, and electrochemical currents caused by device or fixture contamination. Such constant leakage currents cause a voltage-independent capacitance offset.

Keep in mind that insulation resistance and leakage current are aggravated by high humidity as well as by contaminants. In order to minimize these effects, always keep devices and test fixtures in clean, dry conditions.

High-frequency Effects

At measurement frequencies of approximately 100kHz and higher, the impedance of C_{DUT} may be so small that any series impedance in the rest of the circuit may cause errors. Whether such series impedance is caused by inductance (such as from leads or probes), or from resistance (as with a high-resistivity substrate), this series impedance causes non-linearity in the measured capacitance. The resulting C-V curve is, of course, affected by such non-linearity, as shown in Figure 3-32. Note that Model 82-DOS compensates for series resistance (see paragraph 3.6.3).

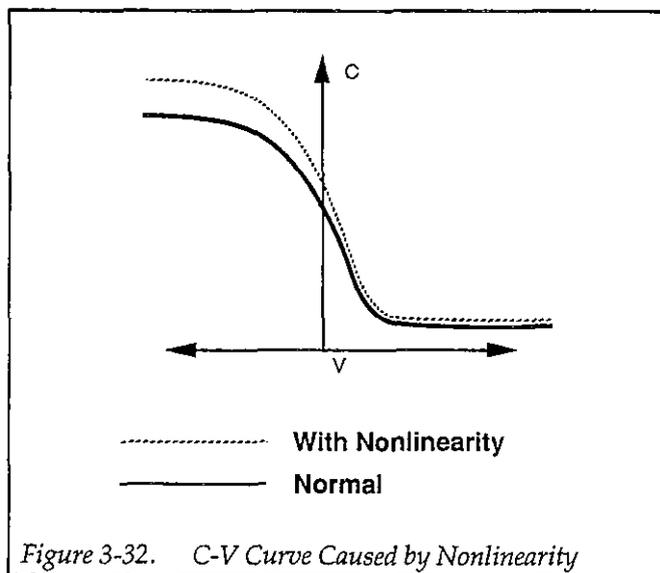

Another high-frequency effect is caused by the AC network formed by the instrumentation, cables, switching circuits, and the test fixtures. Referred to as transmission line error sources, the network essentially transforms the impedance of C_{DUT} when it is referred to the input of the instrument, altering the measured value. Transmission line effects alter the gain and produce non-linearities.

3.9.2 Avoiding Capacitance Errors

The many possible error sources that can affect C-V measurements may seem like a great deal to handle. However, careful attention to a few key details will reduce errors to an acceptable level. Once most of the error sources have been minimized, any residual errors can be further reduced by using the probes-up suppression and corrected capacitance features of the Model 82 software.

Key details that require attention include use of proper cabling and effective shielding. These important aspects are discussed below.

Cabling Considerations

Cables must be used to connect the instruments to the device under test. Ideally, these cables should supply the test voltage to the device unaltered in any way. The test voltage is converted into a current or charge in the DUT, and should be carried back to the instruments undisturbed. Along the way, potential error sources must be minimized.

Coaxial cable is usually used in order to eliminate stray capacitance between the measurement leads. The cable shield is connected to a low-impedance point (guard) that follows the meter input. This technique, known as the three-terminal capacitance measurement, is almost universally used in commercial instrumentation. The shield shunts current away from the input to the guard.

Coaxial cables also serve as smooth transmission lines to carry high-frequency signals without attenuation. For this reason, the cable's characteristic impedance should closely match that of the instrument input and output, which is usually 50Ω. Standard RG-58 cable is adequate for frequencies in the range of 1kHz to more than 10MHz. High-quality BNC connectors with gold-plated center conductors reduce errors from high series contact resistance.

Quasistatic C-V measurements are susceptible to shunt resistance and leakage currents as well as to stray capacitances. Although coaxial cables are still appropriate for these measurements, the cables should be checked to ensure that the insulation resistance is sufficiently high ($>10^{12}\Omega$). Also, when such cables are flexed, the shield rubs against the insulation, generating small currents due to triboelectric effects. These currents can be minimized by using low-noise cable (such as the Model 4801)

that is lubricated with graphite to reduce friction and to dissipate generated charges.

Flex-producing vibration should be eliminated at the source whenever possible. If vibration cannot be entirely eliminated, cables should be securely fastened to prevent flexing.

One final point regarding cable precautions is in order: Cables can only degrade the measurement, not improve it. Thus, cable lengths should be minimized where possible, without straining cables or connections.

Device Connections

Care in properly protecting the signal path should not stop at the cable ends where the connection is made to the DUT fixture. In fact, the device connection is an extremely important aspect of the measurement. For the same reasons given for coaxial cables, it is best to continue the coaxial path as close to the DUT as possible by using coaxial probes. Also, it is important to minimize stray capacitance and maximum insulation resistance in the pathway from the end of the coaxial cable to the DUT.

Most devices have one terminal that is well insulated from other conductors, as in the gate of an MOS test dot. The input should be connected to the gate because it is more susceptible to stray signals than is the output. The output can better tolerate being connected to a terminal with high shunt capacitance, noise, or poor insulation resistance, although these characteristics should still be optimized for best results.

Test Fixture Shielding

At the point where the coaxial cable shielding ends, the sensitive input node is exposed, inviting error sources to interfere. Proper device shielding need not end with the cables or probes, however, if a shielded test fixture is used.

A shielded fixture, sometimes known as a Faraday cage, consists of a metal enclosure that completely surrounds the DUT and leads. In order to be effective, the shield must be electrically connected to the coaxial shield. Typically, bulkhead connectors are mounted to the side of the cage to bring in the signals. Coaxial cables should be continued inside, if possible, or individual input and output leads should be widely spaced in order to maintain input/output isolation.

3.9.3 Correcting Residual Errors

Controlling errors at the source is the best way to optimize C-V measurements, but doing so is not always possible. Remaining residual errors include offset, gain, noise, and voltage-dependent errors. Ways to deal with these error sources are discussed in the following paragraphs.

Offsets

Offset capacitance and conductance caused by the test apparatus can be eliminated by performing a suppression with the probes in the up position. These offsets will then be nulled out when the measurement is made. Whenever the system configuration is changed, the suppression procedure should be repeated. In fact, for maximum accuracy, it is recommended that you perform a probes-up suppression or at least verify prior to every measurement.

Gain and Nonlinearity Errors

Gain errors are difficult to quantify. For that reason, gain correction is applied to every Model 82-DOS measurement. Gain constants are determined by measuring accurate calibration sources during the cable correction process.

Nonlinearity is normally more difficult to correct for than are gain or offset errors. The cable correction utility supplied with Model 82-DOS, however, provides nonlinearity compensation for high-frequency measurements, even for non-ideal configurations such as switching matrices.

Voltage-dependent Offset

Voltage-dependent offset (curve tilt) is the most difficult to correct error associated with quasistatic C-V measurements. It can be eliminated by using the corrected capacitance function of the Model 82-DOS software. In this technique, the current flowing in the device is measured as the capacitance value is measured. The current is known as Q/t because its value is derived from the slope of the charge integrator waveform. Q/t is used to correct capacitance readings for offsets caused by shunt resistance and leakage currents.

Care must be taken when using the corrected capacitance feature, however. When the device is in non-equilibrium, device current adds to any leakage current, with the result that the curve is distorted in the non-equilibrium region. The solution is to keep the device in equilibrium throughout the sweep by carefully choosing the delay time.

Curve Misalignment

At times, quasistatic and high frequency curves may be slightly misaligned due to gain errors or external factors. In such cases, curve gain and offset factors can be applied to the curves to properly align them. This feature is available under the analysis and graphics menus.

Noise

Residual noise on the C-V curve can be minimized by using filtering when taking your data. However, the filter will reduce the sharpness of the curvature in the transition region of the quasistatic curve depending on the number of data points in the region. This change in the curve can cause C_Q to dip below C_H , resulting in erroneous D_{IT} calculations. If this situation occurs, turn off the filter or add more data points.

3.9.4 Interpreting C-V Curves

Even when all the precautions outlined here are followed, there are still some possible obstacles to successfully using C-V curves to analyze semiconductor devices. Semiconductor capacitances are far from ideal, so care must be taken to understand how the device operates. Also, the curves must be generated under well-controlled test conditions that ensure repeatable, analyzable results.

Maintaining Equilibrium

The condition of the device when all internal capacitances are fully charged is referred to as equilibrium. Most quasistatic and high-frequency C-V curve analysis is based on the simplifying assumption that the device is measured in equilibrium. Internal RC time constants limit the rate at which the device bias may be swept while maintaining equilibrium. They also determine the hold time required for device settling after setting the bias voltage to a new value before measuring C_{DUT} .

The two main parameters to be controlled, then, are the bias sweep rate and the hold time. When these parame-

ters are set properly, the normal C-V curves shown in Figure 3-33 result. Once the proper sweep rate and hold time have been determined, it is important that all curves compared with one another be measured under the same test conditions; otherwise, it may be the parameters, not the devices themselves, that cause the compared curves to differ.

Analyzing Curves for Equilibrium

There are three primary indicators that can be used to determine whether a device has remained in equilibrium

during testing. First, as long as a device is in equilibrium, C_{DUT} is settled at all points in the sweep. As a result, it makes no difference whether the sweep goes from accumulation to inversion, or from inversion to accumulation, nor does it matter how rapidly the sweep is performed. Therefore, curves made in both directions will be the same, exhibiting no hysteresis, and any curve made at a slower rate will be the same. Figure 3-34 shows the type of hysteresis that will occur if the sweep rate is too fast, and the device does not remain in equilibrium.

The second equilibrium yardstick requires that the DC current through the device be essentially zero at each

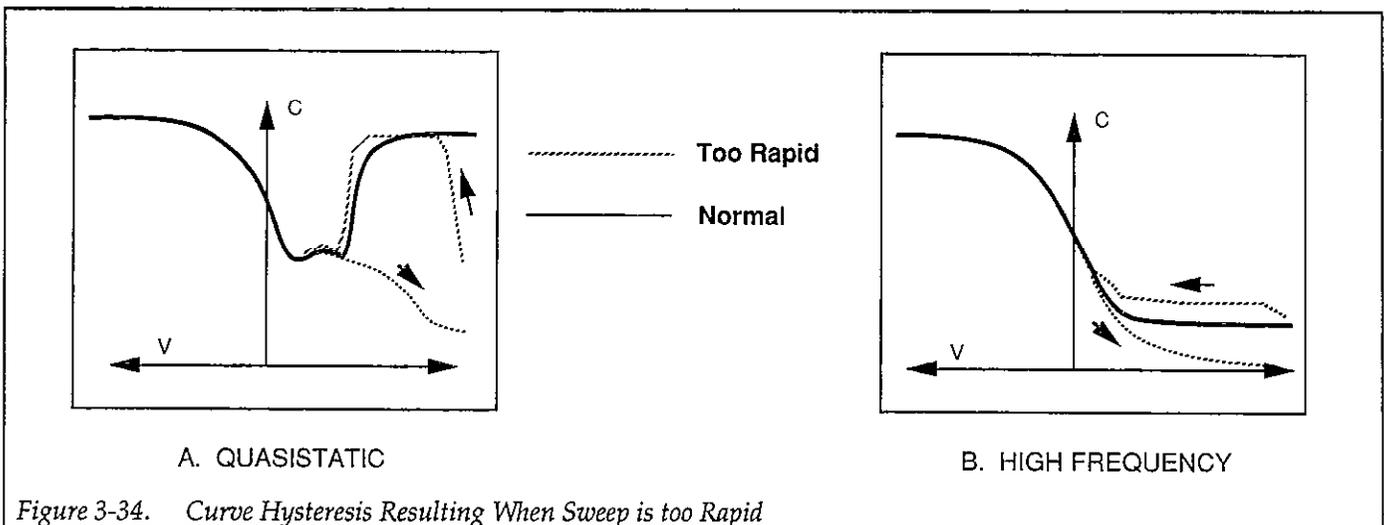
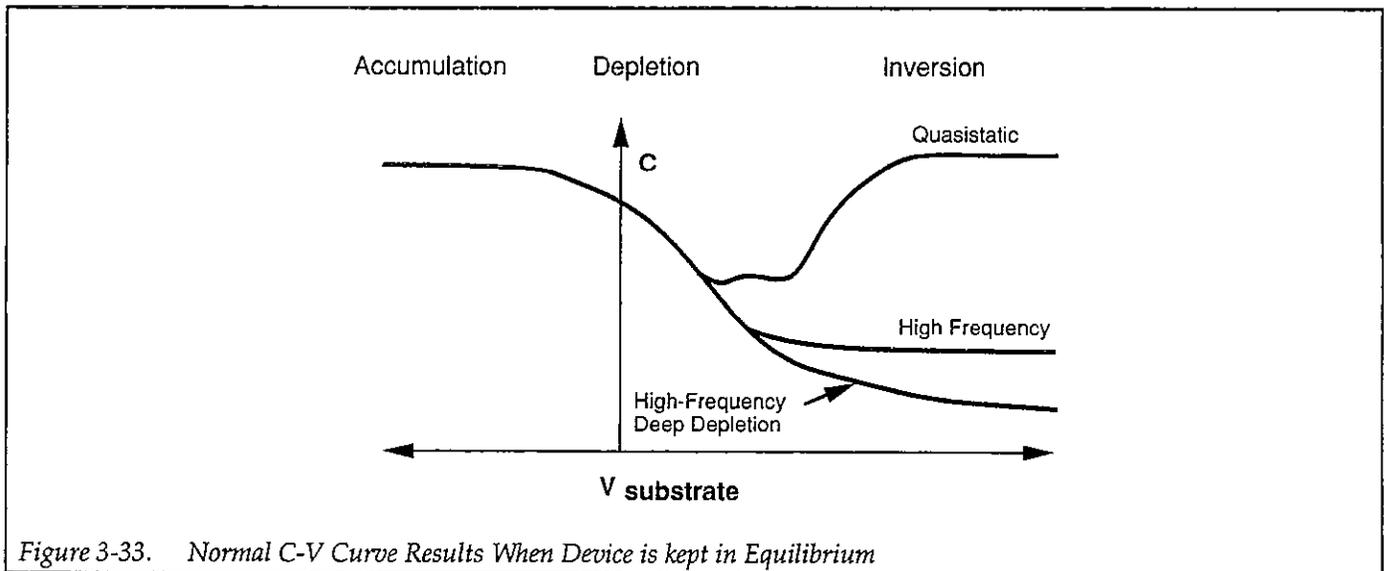

measurement point after device settling. This test can be performed by monitoring Q/t . Thirdly, the curves should exhibit the smooth equilibrium shape. Deviations from the ideal smooth shape indicate a non-equilibrium condition, as in the examples resulting from too short a hold time shown in Figure 3-35. Note that at least two of these indicators should be used together, if possible, because any of the three alone can be misleading at times.

One final quick test to confirm equilibrium is to observe C_Q during a hold time at the end of the C-V sweep from accumulation to inversion. During this final hold time, the capacitance should remain constant. If a curve has been swept too quickly, the capacitance will rise slightly during the final hold time.

Initial Equilibrium

Biasing the device to the starting voltage in the inversion region at the beginning of a C-V measurement creates a non-equilibrium condition that must be allowed to subside before the C-V sweep begins. This recovery to equilibrium can take seconds, minutes, or even tens of minutes to achieve. For that reason, it is generally advantageous to begin the sweep in the accumulation region of the curve whenever possible.

Still, it is often necessary to begin the sweep in the inversion region to check for curve hysteresis. In this case, a light pulse, shone on the device, can be used to quickly generate the minority carriers required by the forming in-

version layer, thus speeding up equilibrium and shortening the hold time.

The best way to ensure equilibrium is initially achieved is to monitor the DC current in the device and wait for it to decay to the DC leakage level of the system. A second indication that equilibrium is reached is that the capacitance level at the initial bias voltage decays to its equilibrium level.

3.9.5 Dynamic Range Considerations

The dynamic range of a suppressed quasistatic or high-frequency measurement will be reduced by the amount suppressed. For example, if, on the 200pF range, you were to suppress a value of 10pF, the dynamic range would be reduced by that amount. Under these conditions, the maximum value the instrument could measure without overflowing would be 190pF.

A similar situation exists when using cable correction with the Model 590. For example, the maximum measurable value on the 2nF range may be reduced to 1.8nF when using cable correction. The degree of reduction will depend on the amount of correction necessary for the particular test setup.

The dynamic range of quasistatic capacitance measurements is reduced with high Q/t . The maximum Q/t value for a given capacitance value depends on both the delay time and the step voltage. See the Model 595 Instruction Manual Specifications for details.

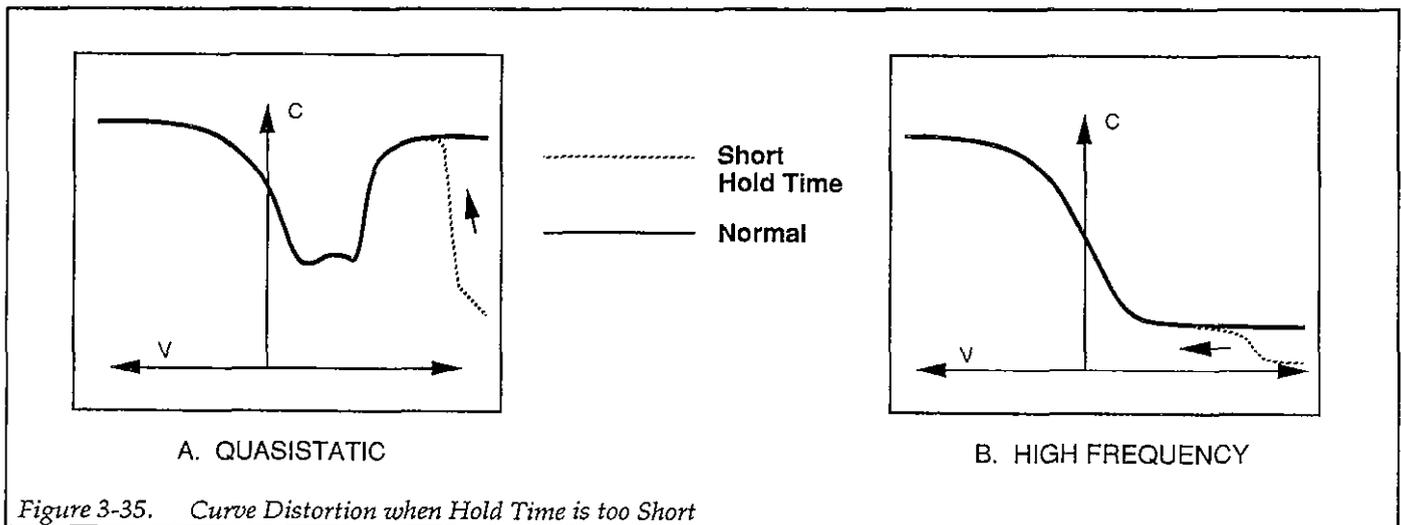
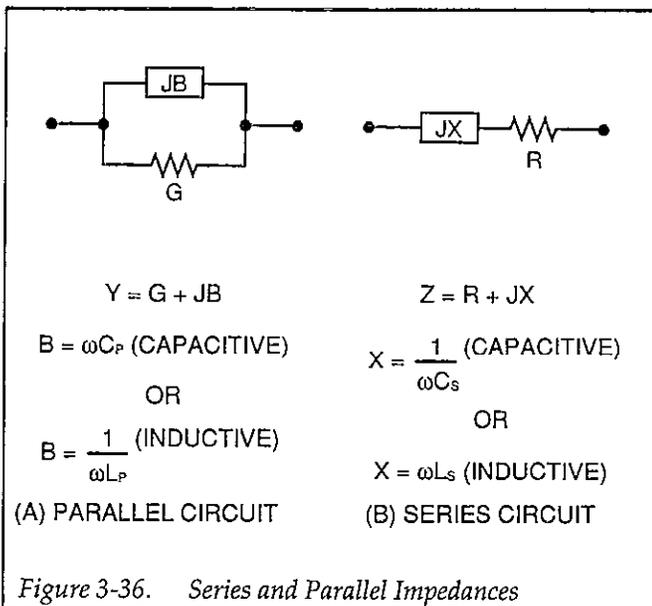

Figure 3-35. Curve Distortion when Hold Time is too Short

3.9.6 Series and Parallel Model Equivalent Circuits

A complex impedance can be represented by a simple series or parallel equivalent circuit made up of a single resistive element and a single reactive element, as shown in Figure 3-36. In the parallel form of (a), the resistive element is represented as the conductance, G , while the reactance is represented by the susceptance, B . The two together mathematically combine to give the admittance, Y , which is simply the reciprocal of the circuit impedance.



In a similar manner, the resistance and reactance of the series form of (b) are represented by R and X , respectively. The impedance of the series circuit is Z .

The net impedances of the equivalent series and parallel circuits at a given frequency are equal. However, the individual components are not. We can demonstrate this relationship mathematically as follows:

$$R + jX = \frac{1}{G + jB}$$

To eliminate the imaginary form in the denominator of the right-hand term, we can multiply both the denomina-

tor and numerator by the conjugate of the denominator as follows:

$$R + jX = \frac{1}{G + jB} \times \frac{G - jB}{G - jB}$$

Performing the multiplication and combining terms, we have:

$$R + jX = \frac{G - jB}{G^2 + B^2}$$

If we assume the reactance is capacitive, we can substitute $-1/\omega C_s$ for the reactance and ωC_p for the susceptance (C_s is the equivalent series capacitance, and C_p is the equivalent parallel capacitance). The above equation then becomes:

$$\frac{R - jX}{\omega C_s} = \frac{G - j\omega C_p}{G^2 + \omega^2 C_p^2}$$

In a lossless circuit (R and G both 0), C_p and C_s would be equal. A practical circuit, however, does have loss because of the finite values of R or G . Thus, C_s and C_p are not equal—the greater the circuit loss, the larger the disparity between these two values.

Series and parallel capacitance values can be converted to their equivalent forms by taking into account a dissipation factor, D . D is simply the reciprocal of the Q of the circuit. For a parallel circuit, the dissipation factor is:

$$D = \frac{1}{Q} = \frac{G}{\omega C_p}$$

For the series circuit, the dissipation factor is defined as:

$$D = \frac{1}{Q} = \omega C_s R$$

By using the dissipation factor along with the formulas summarized in Table 3-3, you can convert from one form to another. Note that C_s and C_p are virtually identical for very small values of D . For example, if D is 0.01 C_s and C_p are within 0.01% of one another.

Example:

Assume that we make a 100kHz measurement on a parallel equivalent circuit and obtain values for C_p and G of

Table 3-3. Converting Series-parallel Equivalent Circuits

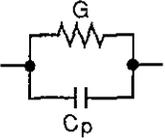
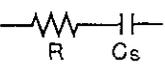
Model	Equivalent Circuit	Dissipation Factor	Capacitance Conversion	Resistance Conductance Conversion
Parallel, C_p, G		$D = \frac{1}{Q} = \frac{G}{\omega C_p}$	$C_s = (1 + D^2) C_p$	$R = \frac{D^2}{(1 + D^2) G}$
Series C_s, R		$D = \frac{1}{Q} = \omega C_s R$	$C_p = \frac{C_s}{1 + D^2}$	$G = \frac{D^2}{(1 + D^2) R}$

160pF and 30μS respectively. From these values, we can calculate the dissipation factor, D , as follows:

$$D = \frac{30 \times 10^{-6}}{2\pi(100 \times 10^3)(160 \times 10^{-12})}$$

$$D = 0.3$$

The equivalent series capacitance is then calculated as follows:

$$C_s = (1 + 0.09) 160\text{pF}$$

$$C_s = 174.4\text{pF}$$

3.9.7 Device Considerations

Series Resistance

Devices with high series resistance can cause measurement and analysis errors unless steps are taken to compensate for this error term. The high dissipation factor caused by series resistance can cause errors in C_{ox} measurement, resulting in errors in analysis functions (such as doping concentration) that use C_{ox} for calculations.

The Model 82-DOS software uses a three-element model to compensate for series resistance (see Figure 4-10). The series resistance, R_{SERIES} , is an analysis constant that can be determined using the procedure covered in paragraph 3.6.3. The default value for R_{SERIES} is 0, which means that data will be unaffected if the value is not changed.

The Model 82-DOS software determines the displayed value of R_{SERIES} by converting parallel model data from the Model 590 into series model data. The resistance value corresponding to the maximum high-frequency capacitance in accumulation is defined as R_{SERIES} . See paragraph 3.9.6 for a detailed discussion of parallel and series model.

Device Structure

The standard analysis used by Model 82-DOS assumes a conventional MIS structure made up of silicon substrate, silicon dioxide insulator, and aluminum gate material. You can change the program for use with other types of materials by modifying the MATERIAL.CON file, as discussed in Appendix A. For compound materials, a weighted average of pertinent material constants is often used. Typical compound materials include silicon nitride and silicon dioxide in a two- or three-layer sandwich.

Device Integrity

In order for analysis to be valid, device integrity should be checked before measurement. Excessive leakage current through the oxide can bleed off the inversion layer, causing the device to remain in nonequilibrium indefinitely. In this situation, the inversion layer would never form completely, and C_{MIN} measurements would be inaccurate.

Device integrity can be verified by monitoring Q/t levels. If Q/t levels are excessive, device integrity is suspect.

3.9.8 Test Equipment Considerations

Light Leaks

High-quality MOS capacitors, which are the subject of C-V analysis, are excellent light detectors. Consequently, care should be taken to ensure that no light leaks into the test fixture or probe station. Typical areas to check include door edges and hinges, tubing entry points, and connectors or connector panels.

Thermal Errors

Accurate temperature control is important for accurate C-V data. For example, the intrinsic carrier concentration, n_i , doubles for every 8°C increase in ambient temperature. In order to minimize the effects of thermal errors, keep the device at a constant temperature during measurement, and repeated measurements should all be made at the same temperature.

If you change the measurement temperature, update the MATERIAL.CON file for correct values for T and n_i (see Appendix A).

SECTION 4

Analysis

4.1 INTRODUCTION

This section covers the various analysis features of the Model 82-DOS software. References and suggested reading are also included at the end of the section.

Information concerning equipment setup and measurement techniques may be found in Sections 2 and 3.

Section 4 information is arranged as follows:

- 4.2 **Constants and Symbols Used for Analysis:** Discusses the numerical constants and mathematical symbols used in this section and by the Model 82-DOS software.
- 4.3 **Obtaining Information from Basic C-V Curves:** Details how to obtain important information such as device type and C_{ox} from C-V curves.
- 4.4 **Analyzing C-V Data:** Discusses loading/saving data and displaying data.
- 4.5 **Analysis Constants:** Covers displaying analysis constants and discusses calculation of constants.

4.6 **Graphical Analysis:** Details graphing of data including measured and calculated data.

4.7 **Mobile Ionic Charge Concentration Measurement:** Discusses two methods to measure the mobile ionic charge concentration in the oxide of an MOS device.

4.8 **References and Bibliography of C-V Measurements and Related Topics:** Lists references used in this section, along with additional texts and papers for suggested reading on C-V measurement and analysis topics.

4.2 CONSTANTS AND SYMBOLS USED FOR ANALYSIS

4.2.1 Default Constants

Constants used by the Model 82-DOS software are defined for silicon substrate, silicon dioxide insulator, and aluminum gate material. These constants are defined in the MATERIAL.CON file, which can be modified for used with other material types (see Appendix A). Default material constants are summarized in Table 4-1.

Table 4-1. Default Material Constants

Symbol	Description	Default Value
q	Electron charge (Coul.)	1.60219×10^{-19} Coul.
k	Boltzmann's constant (J/°K)	1.38066×10^{-23} J/°K
T	Test temperature (°K)	293°K
ϵ_{OX}	Permittivity of oxide (F/cm)	3.4×10^{-13} F/cm
ϵ_S	Semiconductor permittivity (F/cm)	1.04×10^{-12} F/cm
E_G	Semiconductor energy gap (eV)	1.12eV
n_i	Intrinsic carrier concentration (1/cm ³)	1.45×10^{10} cm ⁻³
W_{MS}	Metal work function (V)	4.1V
*	Electron affinity (V)	4.15V

*See MATERIAL.CON file for description (Appendix A).

4.2.2 Raw Data Symbols

The following symbols are used for data measured and sent by the Models 590 and 595. C_Q' is interpolated from C_Q so that C_Q' and C_H are values at the same bias voltage.

C_H	High-frequency capacitance, as measured by the Model 590 at either 100kHz or 1MHz.
C_Q	Quasistatic capacitance measured by the Model 595. C_Q is interpolated from C_Q' so that C_Q' and C_H are values at the same bias voltage
G	High-frequency conductance, as measured by the Model 590 at either 100kHz or 1MHz.
Q/t	Current measured by the Model 595 at the end of each capacitance measurement with the unit in the capacitance function.
V_H	Voltage reading sent by Model 590 with matching C_H and G.

4.2.3 Calculated Data Symbols

Calculated data used by the various analysis algorithms include:

A	Device gate area.
C_{FB}	Flatband capacitance, corresponding to no band bending.
C_{QA}	The quasistatic capacitance that is adjusted according to gain and offset val-

C_Q'	Interpolated value of C_Q set to correspond to the quasistatic capacitance at V.
C_{HA}	The high-frequency capacitance that is adjusted according to gain and offset values. C_{HA} is the value that is actually plotted and printed.
C_{MIN}	Minimum high-frequency capacitance in inversion.
C_{OX}	Oxide capacitance, usually set to the maximum C_H in accumulation.
D_{IT}	Density or concentration of interface states.
E_C	Energy of conduction band edge (valence band is E_V).
E_T	Interface trap energy.
N_A	Bulk doping for p-type (acceptors)
N_D	Bulk doping for n-type (donors)
N_{AVG}	Average doping concentration.
N_{BULK}	Bulk doping concentration.
N_{EFF}	Effective doping concentration.
$N(90\% W_{MAX})$	Doping corresponding to 90% maximum w profile (approximates doping in the bulk).
N_M	Mobile ion concentration in the oxide.
Q_{EFF}	Effective oxide charge
R_{SERIES}	Series resistance
t_{OX}	Oxide thickness.

V_{FB}	Flatband voltage, or the value of V_{GS} that results in C_{FB} .
V_{GS}	Gate voltage. More specifically, the voltage at the gate with respect to the substrate.
$V_{THRESHOLD}$	The point where the surface potential, ψ_s , is equal to twice the bulk potential, ϕ_B .
w	Depletion depth or thickness. Silicon under the gate is depleted of minority carriers in inversion and depletion.
$\Delta(i)$	An intermediate value used in calculations.
ψ_s	Silicon surface potential as a function of V_{GS} . More precisely, this value represents band bending and is related to surface potential via the bulk potential.
ψ_0	Offset in ψ_s due to calculation method and V_0 .
ϕ_B	Silicon bulk potential.
λ	Extrinsic Debye length.

4.3 OBTAINING INFORMATION FROM BASIC C-V CURVES

Much important information about the device under test can be obtained directly from a basic C-V curve. Such information includes device type (p- or n-type material) and C_{ox} (oxide capacitance). These aspects are discussed in the following paragraphs.

4.3.1 Basic C-V Curves

Figure 4-1 and Figure 4-2 show fundamental C-V curves for p-type and n-type materials respectively. Both high-frequency and quasistatic curves are shown in these figures. Note that the high-frequency curves are highly asymmetrical, while the quasistatic curves are almost symmetrical. Accumulation, depletion, and inversion regions are also shown on the curves. The gate-biasing polarity and high-frequency curve shape can be used to determine device type, as discussed below.

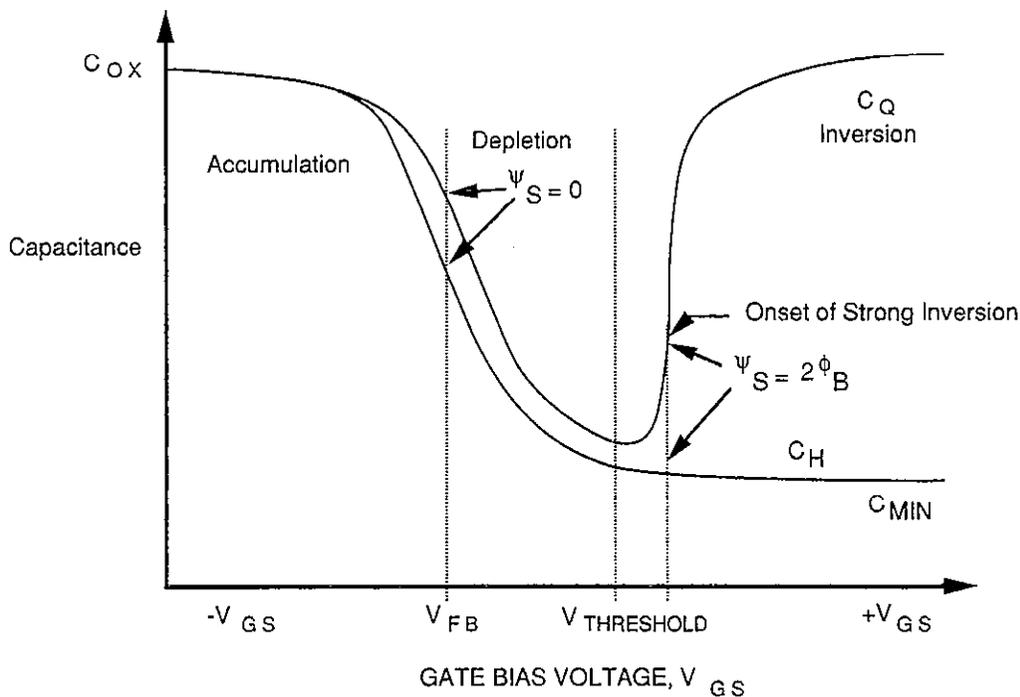

Figure 4-1. C-V Characteristics of p-type Material

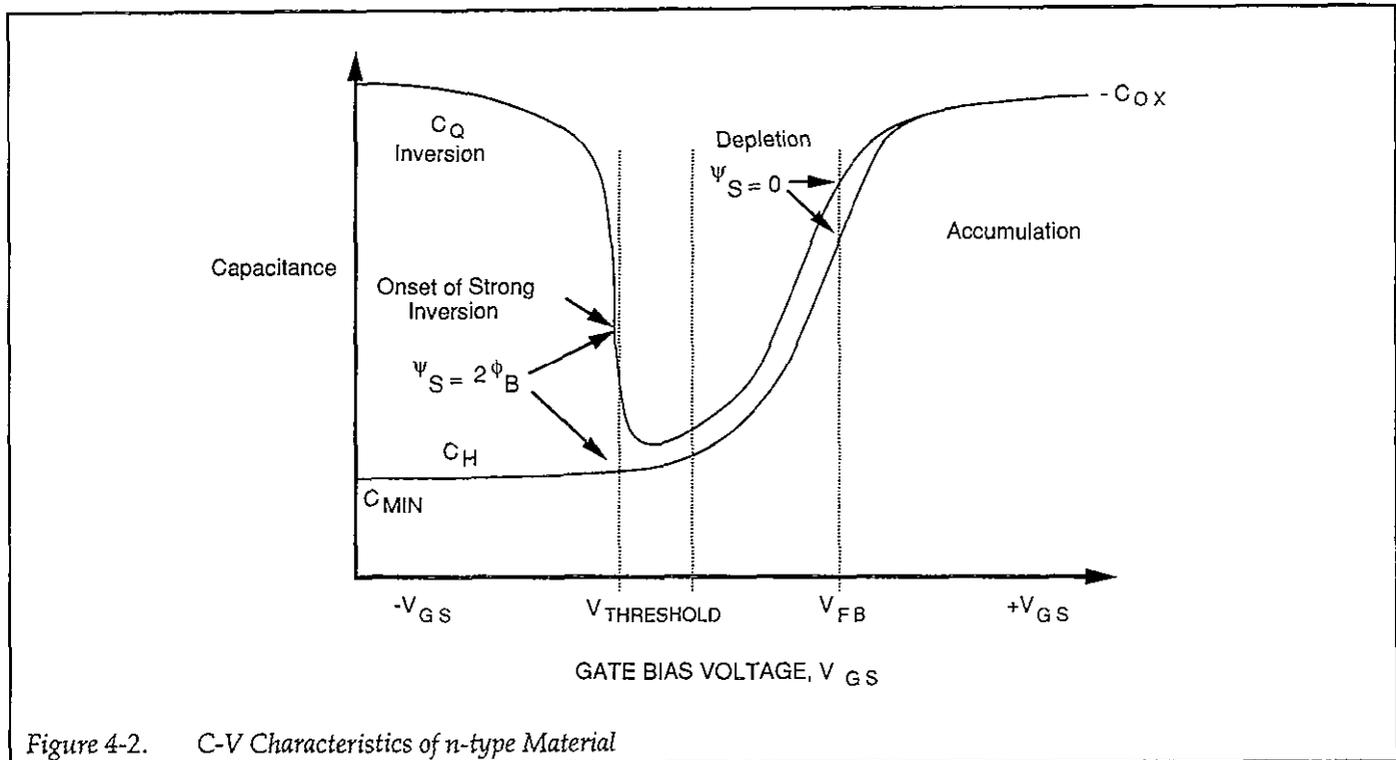

Figure 4-2. C-V Characteristics of n-type Material

4.3.2 Determining Device Type

The semiconductor conductivity type (p or n dopant ions) can be determined from the relative shape of the C-V curves. The high-frequency curve gives a better indication than the quasistatic curve because of its highly asymmetrical nature. Note that the C-V curve moves from the accumulation to the inversion region as gate voltage, V_{GS} , becomes more positive for p-type materials, but the curve moves from accumulation to inversion as V_{GS} becomes more negative with n-type materials (Nicolian and Brews 372-374).

In order to determine the material type, use the following rules:

1. If C_H is greater when V_{GS} is negative than when V_{GS} is positive, the substrate material is p-type.
2. If, on the other hand, C_H is greater with positive V_{GS} than with negative V_{GS} , the substrate is n-type.
3. The end of the curve where C_H is greater is the accumulation region, while the opposite end of the curve is the inversion region. The transitional area between these two is the depletion region. These areas are marked on Figure 4-1 and Figure 4-2.

4.4 ANALYZING C-V DATA

A number of operations can be performed on sweep data stored in a reading array including: saving or loading data to or from disk, displaying or printing reading data, graphing or plotting reading data, as well as mathematical analysis of doping profile, flatband calculations, and interface traps. The following paragraphs discuss analysis operations available with the Model 82-DOS software.

NOTE

You can start the program with analysis by specifying a data file when running the program. See paragraph 2.4.9 for details.

4.4.1 Plotter and Printer Requirements

A plotter or printer can be connected to the serial or parallel port, or to the IEEE-488 bus (plotter only) to obtain hard copy graphs. Paragraph 2.4 discusses recommended plotters and printers, as well as how to define the equipment during installation or reconfiguration.

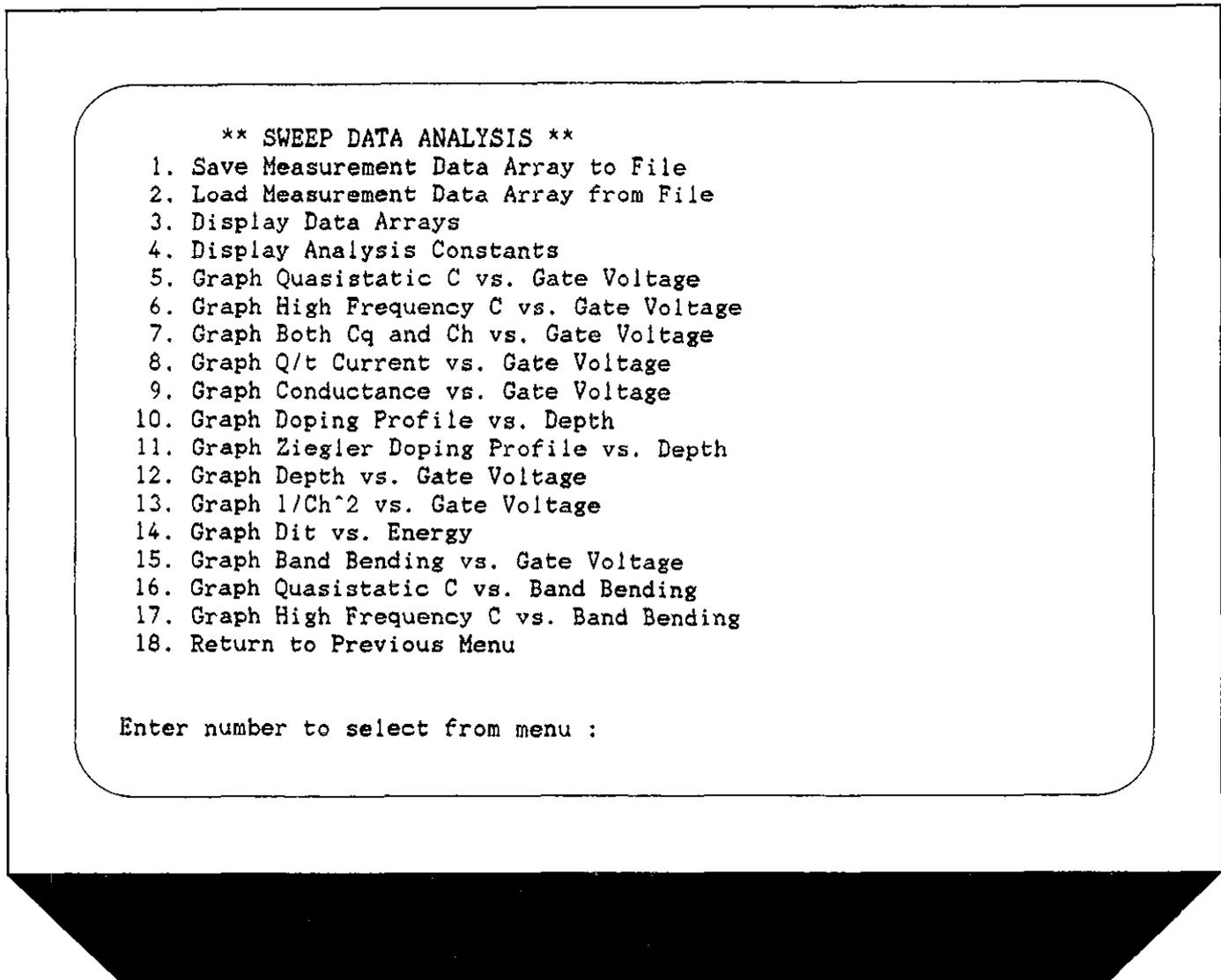

Figure 4-3. Data Analysis Menu

4.4.2 Analysis Menu

Figure 4-3 shows the analysis menu. You can access this menu either by selecting option 5, Analyze C-V Data, on the main menu, or through most other submenus.

Key operations available on the menu include:

- Saving or loading reading and graphics array data to or from disk.
- Displaying (CRT) or printing (external printer) reading or graphics array data.

- Displaying or modifying numerical constants such as C_{ox} , t_{ox} , and N (doping concentration).
- Graphing or plotting reading array data.
- Graphical and mathematical analysis of the data array.

4.4.3 Saving and Recalling Data

By selecting option 1 or 2 you can save the current reading and graphics arrays to diskette, or load previous data into the reading arrays. See Appendix I for data format details.

NOTE

Loading data from diskette will overwrite any data currently stored in the reading and graphics arrays. Data analysis and graphing is always carried out using data currently stored in the reading or graphics arrays.

Saving the Data

Use the following procedure to save sweep and graphics data presently stored in memory.

1. Select option 1 on the analysis menu.
2. The computer will display the current disk directory.
3. You will then be prompted to type in the desired filename. Be sure to choose a name not on the present directory. Also, you need not type in the file extension (.DAT). You can also use the full path name to specify another directory or disk drive (for example, A:MYFILE or C:\PATH\MYFILE).
4. Next you will be prompted to enter two lines of header information, up to a maximum of 160 characters. This feature can be used to enter important information about the data you are saving. For example, you may wish to enter the type of device, the date, and the time the data was taken for future reference.
5. After entering header information, you will be given one last opportunity to change it.
6. Next, you will be prompted to choose one of the following data delimiters: comma, space or tab. This feature allows you to choose a file format compatible with other programs such as spreadsheet programs (you can use any of the three delimiters for Model 82-DOS file operations).
7. Once you have chosen the delimiter, the data file will be saved.

NOTE

Refer to Appendix I for information on importing data into other programs.

Loading Data

Use the procedure below to recall data from disk and store it to the reading and graphics arrays. Remember that any data presently in the reading and graphics arrays will be overwritten by the data loaded from disk.

1. Select option 2 on the analysis menu. The computer will then display the current disk directory.

2. At the prompt, type in the desired filename and press ENTER (specify the complete path if file is on a different drive or directory). You need not specify the .DAT extension.
3. If the file exists, the arrays will be filled with the data from the file; however, an error message will be given if the file does not exist, or if it is of the wrong type.
4. To return to the analysis menu, press ENTER.

4.4.4 Displaying and Printing the Reading and Graphics Arrays

By selecting option 3 on the Sweep Data Analysis menu, you can display array data on the computer CRT or print out that array data for hardcopy. In order to print the data, you must, of course, have a printer connected to the computer. When displaying array data, the screen will be cleared before arrays are displayed.

Note that you can display or print either reading or graphics array data by selecting the appropriate option on the submenu. The displayed and printed reading array data includes the reading number; quasistatic capacitance, current (Q/t); and high-frequency capacitance, conductance, and gate voltage. An example is shown in Figure 4-4.

NOTE

The quasistatic and high-frequency capacitance values that are plotted, printed, and used in calculations are first corrected for gain and offset (paragraph 4.4.7) to obtain C_{QA} and C_{HA} (adjusted capacitance).

Graphics array data includes depletion depth, doping concentration, band bending, interface trap energy, I/C^2 , and interface trap density. An example is shown in Figure 4-5. Ziegler (MCC) doping and depth are displayed separately, as shown in Figure 4-6.

NOTE

Values of 10^{32} "flag" invalid data as explained in paragraph 4.4.8.

When displaying data on the CRT, you have the option of selecting the first reading number to display.

To print out only a portion of the array, display that portion on the screen, then press the PRINT SCREEN key.

Rdg#	Q/t (pA)	G (uS)	Cq (pF)	Ch (pF)	Vgs
1	-1.8000E-01	+1.1000E+00	+2.4972E+02	+2.5060E+02	+5.840
2	-1.8000E-01	+1.1000E+00	+2.5019E+02	+2.5050E+02	+5.740
3	-1.8000E-01	+1.1000E+00	+2.5041E+02	+2.5050E+02	+5.640
4	-1.8000E-01	+1.1000E+00	+2.5054E+02	+2.5040E+02	+5.540
5	-1.8000E-01	+1.1000E+00	+2.5061E+02	+2.5040E+02	+5.440
6	-1.8000E-01	+1.1000E+00	+2.5071E+02	+2.5030E+02	+5.340
7	-1.8000E-01	+1.1000E+00	+2.5063E+02	+2.5040E+02	+5.230
8	-1.9000E-01	+1.1000E+00	+2.5045E+02	+2.5020E+02	+5.140
9	-2.0000E-01	+1.1000E+00	+2.5019E+02	+2.5010E+02	+5.030
10	-2.0000E-01	+1.1000E+00	+2.5014E+02	+2.5020E+02	+4.930

Press ENTER to continue or enter a reading number. Enter Q to quit :

Figure 4-4. Example of Reading Array Print Out

Selecting the Graphics Range

The graphics range defines the array limits to be plotted. To change the graphics range, (select graphics range) select option 3 on the analysis menu, then option 7 on the subsequent menu. The present graphics range along with best depth and total array size will be displayed. Key in the first and last readings at the corresponding prompts.

One particularly good use for this feature is to select the range for best depth. The range over which N and D_{IT} are accurate to within $\pm 5\%$ is equal to best depth. The graphics range can also be used to zoom in on interesting sections of other curves.

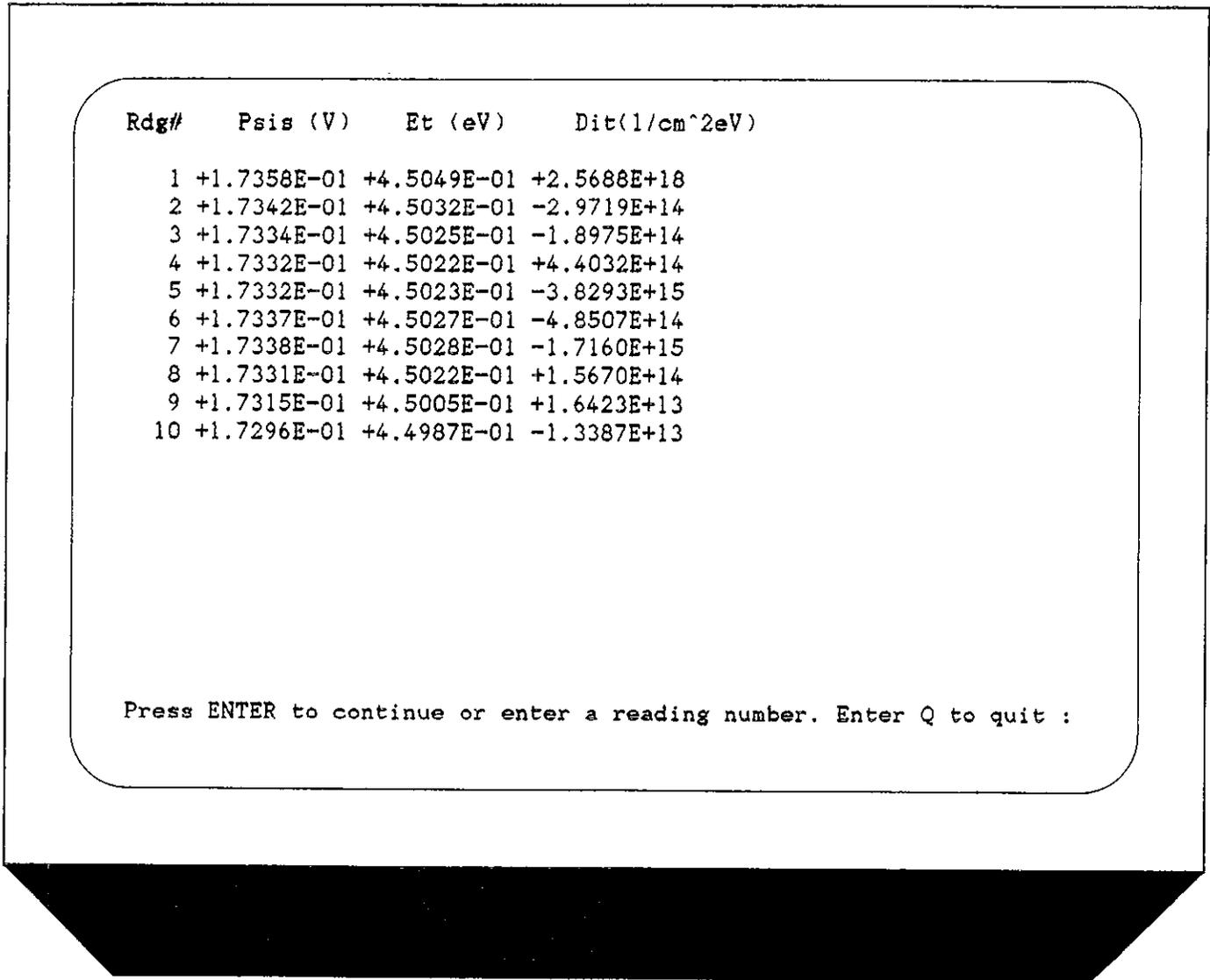

Figure 4-5. Example of Graphics Array Print Out

```
----- Ziegler -----  
Rdg#   w (um)   N (cm^-3)   w (um)   N (cm^-3)   1/Ch^2  
1 -3.3636E-08 -5.4132E+22 -3.3636E-08 -5.4132E+22 +1.5923E-05  
2 +1.6565E-04 +1.0000E+32 +1.6565E-04 +1.0000E+32 +1.5936E-05  
3 +1.6565E-04 +1.8272E+18 +5.2048E-05 +6.0907E+17 +1.5936E-05  
4 +3.3146E-04 +1.0000E+32 +3.3146E-04 +1.0000E+32 +1.5949E-05  
5 +3.3146E-04 -5.0791E+16 +3.1218E-04 -1.6930E+16 +1.5949E-05  
6 +4.9740E-04 +3.8183E+17 +1.1386E-04 +1.2728E+17 +1.5962E-05  
7 +3.3146E-04 -5.4602E+16 +3.0109E-04 -1.8201E+16 +1.5949E-05  
8 +6.6348E-04 +3.9755E+17 +1.1158E-04 +1.3252E+17 +1.5974E-05  
9 +8.2969E-04 -7.7665E+17 +7.9833E-05 -2.5888E+17 +1.5987E-05  
10 +6.6348E-04 +1.0880E+18 +6.7450E-05 +3.6266E+17 +1.5974E-05
```

Press ENTER to continue or enter a reading number. Enter Q to quit :

Figure 4-6. Example of Ziegler (MCC) Doping Array Print Out

4.5 ANALYSIS CONSTANTS

Table 4-2 summarizes analysis constants. These constants are covered in detail in the following paragraphs.

Constants that can be changed include:

1. R_{SERIES}
2. C_{OX} and tox or Area
3. N_{BULK}
4. C_{MIN}

To change these constants, select option 1 (Change constants) on the analysis constants menu (see Figure 4-7), and type in the desired values when prompted to do so. Constants that can be changed are discussed in paragraphs 4.5.1 through 4.5.4. Calculations for many other constants are discussed in subsequent paragraphs.

Table 4-2. Analysis Constants

Constants	Menu Term	Description	Units
C _{OX}	Cox	Oxide capacitance	pF
R _{SERIES}	Rseries	Series resistance	ohms
N _{BULK}	Nbulk	Bulk doping concentration	cm ⁻³
C _{FB}	Cfb	Flatband capacitance	pF
V _{THRESHOLD}	Vthresh	Threshold voltage	V
tox	tox	Oxide thickness	nm
C _{MIN}	Cmin	Minimum capacitance	pF
φ _B	PhiB	Bulk doping	cm ⁻³
V _{FB}	Vfb	Flatband voltage	V
N _{EFF}	Neff	Effective oxide charge concentration	1/cm ²
Area	Area	Gate area	cm ²
N _{AVG}	Navg	Average doping concentration	cm ⁻³
λ	Lb	Extrinsic Debye length	μm
W _{MS}	Work Fn	Work function difference	V
Q _{EFF}	Qeff	Effective oxide charge	coul/cm ²
	DevType	Device type	n or p
	Best depth	Best depth	μm

```
*** Analysis Constants ***  
Cox(pF):+2.5060E+02      tox(nm):+1.3567E+02      Area(cm^2):+1.0000E-02  
Rseries(ohms):+4.4000E-01  Cmin(pF):+7.3700E+01      Navg(cm^-3):+1.3654E+19  
Nbulk(cm^-3):+8.4000E+14  PhiB(V):+2.7690E-01      Lb(um):+1.3968E-01  
Cfb(pF):+1.8749E+02      Vfb(V):-3.9316E-01      Work Fn(V):-3.3310E-01  
Vthresh(V):-1.4438E+00  Neff(1/cm^2):+9.3945E+09  Qeff(coul/cm^2):+1.5052E-09  
DevType: n  
  
Best depth(um):      +4.1905E-01      ---- to ----      +9.2515E-01  
Cq gain:+1.0000E+00      Cq offset(pF): +0.0000E+00  
Ch gain:+1.0000E+00      Ch offset(pF): +0.0000E+00  
  
Menu: 1) Change constants  2) Gain/Offset  3) Print  4) Exit  
  
Enter number to select from menu :
```

Figure 4-7. Analysis Constants Display

4.5.1 Oxide Capacitance, Thickness, and Area Calculations

The oxide capacitance, C_{ox} , is the high-frequency capacitance with the device biased in strong accumulation. The value of C_{ox} can be determined using the procedure outlined in paragraph 3.6.3.

Oxide thickness is calculated from C_{ox} and gate area as follows:

$$t_{ox} = \frac{A \epsilon_{ox}}{(1 \times 10^{-19}) C_{ox}}$$

Where: t_{ox} = oxide thickness (nm)
 A = gate area (cm²)
 ϵ_{ox} = permittivity of oxide material (F/cm)
 C_{ox} = oxide capacitance (pF)

The above equation can be easily rearranged to calculate to solve for gate area if the oxide thickness is known.

Note that ϵ_{ox} and other constants are defined in the MATERIAL.CON file and are initialized for use with silicon substrate, silicon dioxide insulator, and aluminum gate material. See Appendix A for information on changing these constants for use with other materials.

4.5.2 Series Resistance Calculations

The series resistance, R_{SERIES} , is an error term that can cause measurement and analysis errors unless this series resistance error factor is taken into account. The value of R_{SERIES} can be determined empirically using the procedure discussed in paragraph 3.6.3.

Without series compensation, capacitance can be lower than normal, and C-V curves can be distorted: Compare the uncompensated C-V curve in Figure 4-8 with the compensated curve in Figure 4-9.

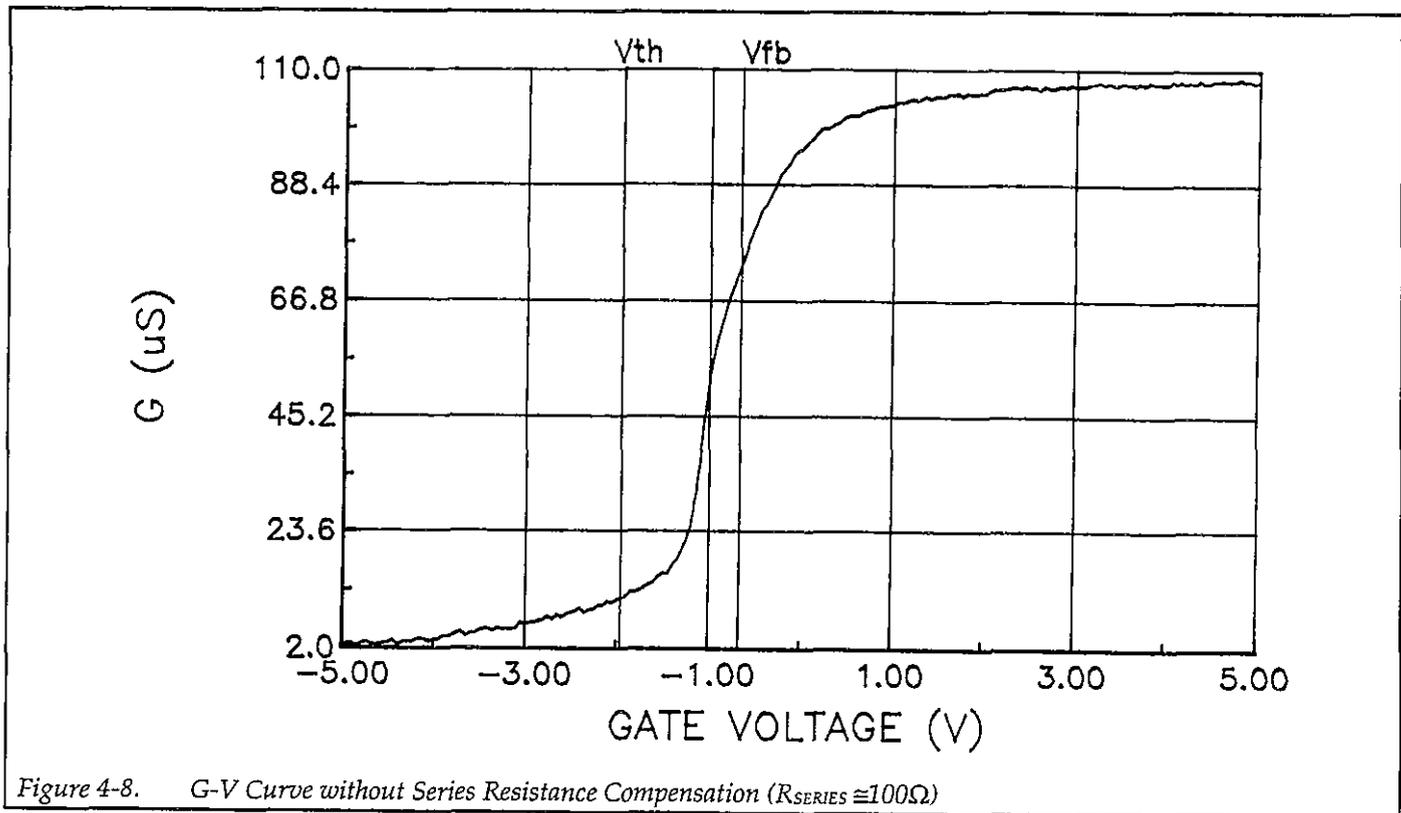
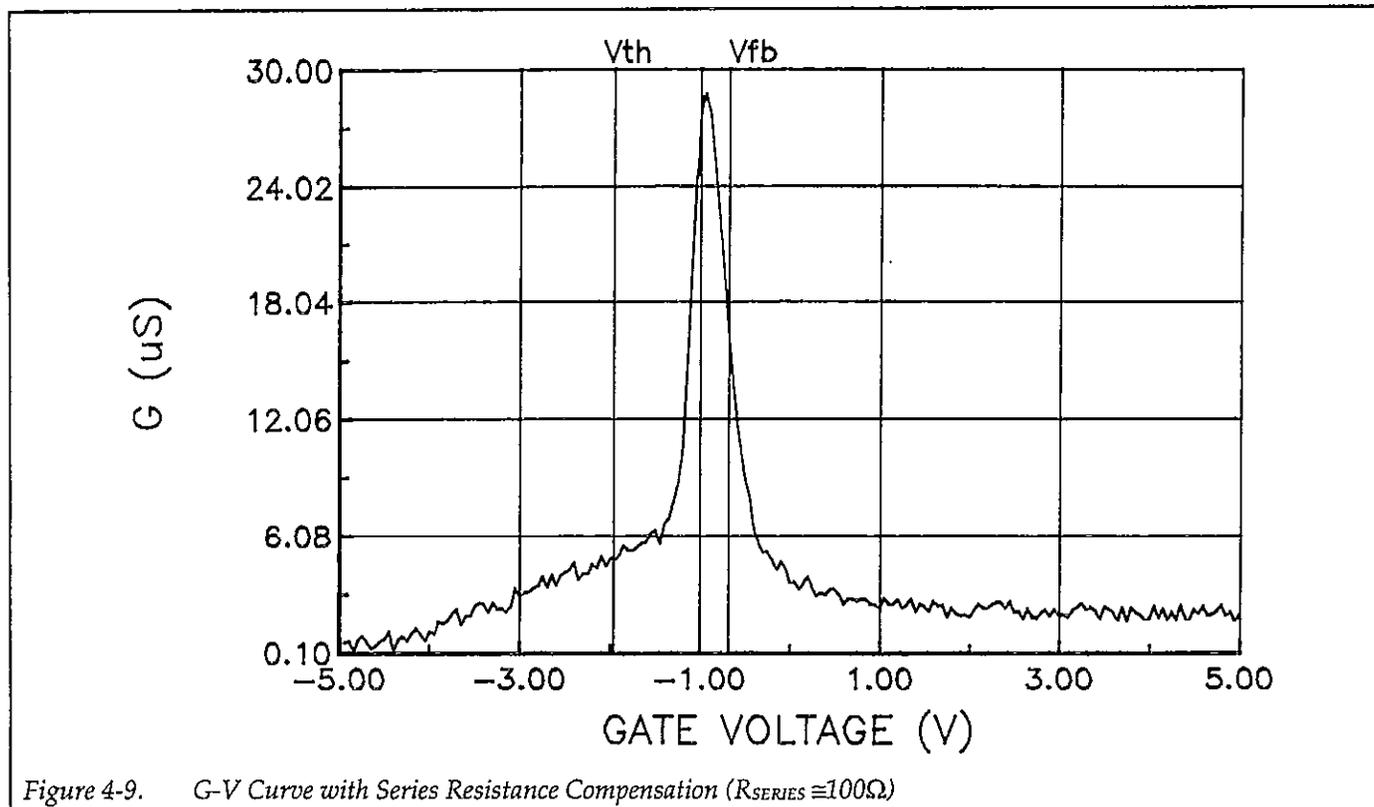

Figure 4-8. G-V Curve without Series Resistance Compensation ($R_{SERIES} \cong 100\Omega$)



The Model 82-DOS software compensates for series resistance using the simplified three-element model shown in Figure 4-10. In this model, C_{OX} is, of course, the oxide capacitance while C_A is the capacitance of the accumulation layer. The series resistance is represented by R_{SERIES} .

From Nicollian and Brews 224, the correction capacitance, C_c , and corrected conductance, G_c , are calculated as follows:

$$C_c = \frac{(G_M^2 + \omega^2 C_M^2) C_M}{a^2 + \omega^2 C_M^2}$$

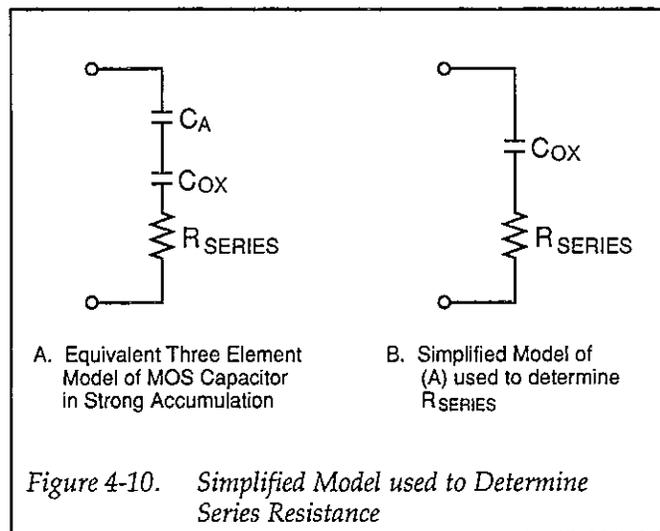

and,

$$G_c = \frac{(G_M^2 + \omega^2 C_M^2) a}{a^2 + \omega^2 C_M^2}$$

Where: $a = G_M - (G_M^2 + \omega^2 C_M^2) R_{\text{SERIES}}$
 C_c = series resistance compensated parallel model capacitance
 C_M = measured parallel model capacitance
 G_c = series resistance compensated conductance
 G_M = measured conductance
 R_{SERIES} = series resistance

4.5.3 Changing N_{BULK}

N_{BULK} is one of the analysis constants that can be entered. To change this value, select option 1, Change constants, and enter the requested values at the corresponding prompts. Typically, N_A or N_D will be entered using this function. Note that the graphics arrays will be recalculated if N_{BULK} is changed.

4.5.4 Changing C_{MIN}

C_{MIN} is the value of high-frequency capacitance with the device biased in strong inversion. The C_{MIN} is one of the constants used to calculate N_{AVG} , and its value can be determined using the procedure outlined in paragraph 3.6.4.

To enter a new C_{MIN} value from the analysis constants menu, select option 1, Change constants, and enter the value at the appropriate prompt.

4.5.5 Flatband Capacitance and Flatband Voltage

Model 82-DOS uses the flatband capacitance method of finding flatband voltage, V_{FB} . The Debye length is used to calculate the ideal value of flatband capacitance, C_{FB} . Once the value of C_{FB} is known, the value of V_{FB} is interpolated from the closest V_{GS} values (Nicollian and Brews 487-488).

The method used is invalid when interface trap density becomes very large (10^{12} – 10^{13} and greater). However, this algorithm should give satisfactory results for most users. Those who are dealing with high values of D_{IT} should consult the appropriate literature for a more appropriate method and modify the Model 82-DOS software accordingly.

Based on doping, the calculation of C_{FB} uses N at 90% W_{MAX} , or user-supplied N_A (bulk doping for p-type, acceptors) or N_D (bulk doping for n-type, donors).

C_{FB} is calculated as follows:

$$C_{FB} = \frac{C_{OX} \epsilon_s A / (1 \times 10^{-4}) (\lambda)}{(1 \times 10^{-12}) (C_{OX}) + \epsilon_s A / (1 \times 10^{-4}) (\lambda)}$$

Where: C_{FB} = flatband capacitance (pF)
 C_{OX} = oxide capacitance (pF)
 ϵ_s = permittivity of substrate material (F/cm)
 A = gate area (cm²)
 1×10^{-4} = units conversion for λ
 1×10^{-12} = units conversion for C_{OX}

And λ = extrinsic Debye length =

$$(1 \times 10^4) \left(\frac{\epsilon_s kT}{q^2 N_x} \right)^{1/2}$$

Where: kT = thermal energy at room temperature (4.046×10^{-21} J)
 q = electron charge (1.60219×10^{-19} coul.)
 $N_x = N$ at 90% W_{MAX} , or N_A or N_D when input by the user.

N at 90% W_{MAX} is chosen to represent bulk doping.

To change the value of N to N_A or N_D , select option 1, Change constants, then enter the new value as N_{BULK} .

4.5.6 Threshold Voltage

The threshold voltage, $V_{THRESHOLD}$, is the point on the C-V curve where the surface potential ψ_s , equals twice the bulk potential, ϕ_b . This point on the curve corresponds to the onset of strong inversion (see Figures 4-1 and 4-2). For an enhancement mode MOSFET, $V_{THRESHOLD}$ corresponds to the point where the device begins to conduct. Note that threshold voltage is displayed as V_t on graphs that plot V_{GS} on the X axis.

$V_{THRESHOLD}$ is calculated as follows:

$$V_{THRESHOLD} = \left[\pm \frac{A}{10^{12} C_{OX}} \sqrt{4 \epsilon_s q |N_{BULK}| |\phi_b|} + 2 |\phi_b| \right] + V_{FB}$$

Where: $V_{\text{THRESHOLD}}$ = threshold voltage (V)
 A = gate area (cm^2)
 C_{OX} = oxide capacitance (pF)
 10^{12} = units multiplier
 ϵ_s = permittivity of substrate material
 q = electron charge (1.60219×10^{-19} coul.)
 N_{BULK} = bulk doping (cm^{-3})
 ϕ_B = bulk potential (V)
 V_{FB} = flatband voltage (V)

$W_{\text{MS}} = -0.95\text{V}$. Also, for the same gate and n-type silicon ($N_{\text{BULK}} = 10^{16}\text{cm}^{-3}$), $W_{\text{MS}} = -0.27\text{V}$.

NOTE

Model 82-DOS can be modified for use with materials other than silicon, silicon dioxide, and aluminum. See Appendix A for details.

4.5.7 Metal Semiconductor Work Function Difference

The metal semiconductor work function difference, W_{MS} , is commonly referred to as the work function. It contributes to the shift in V_{FB} from the ideal zero value, along with the effective oxide charge (Nicollian and Brews 462-477, Sze 395-402). The work function represents the difference in work necessary to remove an electron from the gate and from the substrate, and it is derived as follows:

$$W_{\text{MS}} = W_{\text{M}} - \left[W_{\text{S}} + \frac{E_{\text{G}}}{2} - \phi_{\text{B}} \right]$$

Where: W_{M} = metal work function
 W_{S} = substrate material work function (electron affinity)
 E_{G} = substrate material bandgap
 ϕ_{B} = bulk potential

For silicon, silicon dioxide, and aluminum:

$$W_{\text{MS}} = 4.1 - \left[4.15 + \frac{1.12}{2} - \phi_{\text{B}} \right]$$

So that,

$$W_{\text{MS}} = -0.61 + \phi_{\text{B}}$$

$$W_{\text{MS}} = -0.61 - \left(\frac{kT}{q} \right) \ln \left(\frac{N_{\text{BULK}}}{n_i} \right) (\text{Dope Type})$$

Where, Dope Type is +1 for p-type materials, and -1 for n-type materials. For example, for an MOS capacitor with an aluminum gate and p-type silicon ($N_{\text{BULK}} = 10^{16}\text{cm}^{-3}$),

4.5.8 Effective Oxide Charge

The effective oxide charge, Q_{EFF} , represents the sum of oxide fixed charge, Q_{F} , mobile ionic charge, Q_{M} , and oxide trapped charge, Q_{OT} . Q_{EFF} is distinguished from interface trapped charge, Q_{IT} , in that Q_{IT} varies with gate bias and $Q_{\text{EFF}} = Q_{\text{F}} + Q_{\text{M}} + Q_{\text{OT}}$ does not (Nicollian and Brews 424-429, Sze 390-395). Simple measurements of oxide charge using C-V measurements do not distinguish the three components of Q_{EFF} . These three components can be distinguished from one another by temperature cycling, as discussed in Nicollian and Brews, 429, Fig. 10.2. Also, since the charge profile in the oxide is not known, the quantity, Q_{EFF} should be used as a relative, not absolute measure of charge. It assumes that the charge is located in a sheet at the silicon-silicon dioxide interface. From Nicollian and Brews, Eq. 10.10, we have:

$$V_{\text{FB}} - W_{\text{MS}} = - \frac{Q_{\text{EFF}}}{C_{\text{OX}}}$$

Note that C_{OX} here is per unit of area. So that,

$$Q_{\text{EFF}} = \frac{C_{\text{OX}}(W_{\text{MS}} - V_{\text{FB}})}{A}$$

However, since C_{OX} is in F, we must convert to pF by multiplying by 10^{-12} as follows:

$$Q_{\text{EFF}} = 10^{-12} \frac{C_{\text{OX}}(W_{\text{MS}} - V_{\text{FB}})}{A}$$

Where: Q_{EFF} = effective charge (coul/cm²)
 C_{OX} = oxide capacitance (pF)
 W_{MS} = metal semiconductor work function (V)
 A = gate area (cm^2)

For example, assume a 0.01cm^2 50pF capacitor with a flatband voltage of -5.95V , and a p-type $N_{\text{BULK}} = 10^{16}\text{cm}^{-3}$ (re-

sulting in $W_{MS} = -0.95V$). Such a capacitor would have a $Q_{EFF} = 2.5 \times 10^{-8}$ coul/cm².

4.5.9 Effective Oxide Charge Concentration

The effective oxide charge concentration, N_{EFF} , is computed from effective oxide charge and electron charge as follows:

$$N_{EFF} = \frac{Q_{EFF}}{q}$$

Where: N_{EFF} = effective concentration of oxide charge (Units of charge/cm²)
 Q_{EFF} = effective oxide charge (coul./cm²)
 q = electron charge (1.60219×10^{-19} coul.)

For example, with an effective oxide charge of 2.5×10^{-8} coul/cm², the effective oxide charge concentration is:

$$N_{EFF} = \frac{2.5 \times 10^{-8}}{1.60219 \times 10^{-19}}$$

$$N_{EFF} = 1.56 \times 10^{11} \text{ units/cm}^2$$

4.5.10 Average Doping Concentration

The average doping concentration, N_{AVG} , is displayed on the analysis constants menu. N_{AVG} is calculated as follows:

$$\frac{\ln(N_{AVG}/n_i)}{N_{AVG}} = \left[\frac{q^2 \epsilon_s t_{OX}}{4kT \epsilon_{OX}^2} \left[\frac{C_{MAX} - C_{MIN}}{C_{MIN}} \right]^2 \right]$$

Where: N_{AVG} = average doping concentration
 n_i = intrinsic carrier concentration of material used
 q = electron charge (1.60219×10^{-19} coul.)
 ϵ_s = permittivity of substrate material
 t_{OX} = oxide thickness (cm)
 k = Boltzmann's constant (1.38066×10^{-23} J/°K)
 T = test temperature (°K)
 ϵ_{OX} = permittivity of oxide material

C_{MAX} = maximum measured high-frequency capacitance
 C_{MIN} = minimum high-frequency capacitance (as determined using procedure in paragraph 3.6.4)

The above equation cannot be explicitly solved, and its solution is only approximate. To obtain the approximate solution, the Model 82 software performs a binary search in the range of $10^{10} < N < 10^{20}$. The search begins at the end points and takes an average of the two results to determine a test value for N . The error is then calculated as follows:

$$\text{Error} = \left[\frac{q^2 \epsilon_s t_{OX}}{4kT \epsilon_{OX}^2} \left[\frac{C_{MAX} - C_{MIN}}{C_{MIN}} \right]^2 \right] \cdot N - \ln(N_{AVG}/n_i)$$

Since the average doping concentration equation above has no closed form solution for N_{AVG} , the equation is solved by minimizing the error in the interval from 10^{10} to 10^{20} . A 0.01% criteria is used with an upper limit of 100 iterations.

NOTE

Correct calculation of N_{AVG} requires that C_{MIN} be properly determined. C_{MIN} is the high-frequency capacitance value with the device biased in strong inversion, and the value of C_{MIN} can be determined using the procedure discussed in paragraph 3.6.4. Accurate C_{MIN} also depends on proper values for t_{OX} and/or area.

4.5.11 Best Depth

The calculated values of N and D_{IT} have nominal error of $\pm 5\%$ when the depletion depth, w , falls within the following limits:

$$3\lambda \leq w \leq 2\lambda \sqrt{\ln(N_x/n_i)}$$

Where: λ = extrinsic Debye length
 w = depletion depth (μm)
 $N_x = N$ at 90% W_{MAX} , N_A , or N_D
 n_i = intrinsic carrier concentration

This accuracy range is displayed as best depth on the analysis constants menu. To set the graphics range to best

depth, select option 3, display data arrays on the analysis menu, then select option 7, select graphics range. Type in the graphics range values equal to the displayed best depth values.

4.5.12 Gain and Offset

Option 2 on the analysis constants menu allows you to change gain and offset values applied to C_Q and C_H data. Gain and offset can be applied to these data to allow for curve alignment or to compensate for measurement errors. A gain factor is a multiplier that is applied to all elements of C_Q or C_H array data before plotting or graphics array calculation, and offset is a constant value added to or subtracted from all C_Q and C_H data before plotting or array calculation. The adjusted capacitance values are called C_{QA} and C_{HA} , and all gain/offset-compensated readings are indicated as such on the computer screen.

For example, assume that you compare the C_Q and C_H values at reading #3, and you find that C_Q is 2.3pF less than C_H . If you then add an offset of +2.3pF to C_Q , the C_Q

and C_H values at reading #3 will then be the same, and the C_Q and C_H curves will be aligned at that point.

Gain and offset values do not affect raw C_Q and C_H values stored in the data file, but the gain and offset values will be stored in the data file so that compensated curves can easily be regenerated at a later date.

To disable gain, program a value of unity (1). Similarly, program a value of 0 to disable offset.

4.6 GRAPHICAL ANALYSIS

4.6.1 Analysis Tools

Table 4-3 summarizes the graphical analysis tools available with Model 82-DOS. To generate an analysis graph, select the corresponding option from the analysis menu, then use the graphics control menu discussed in paragraph 4.6.2 to tailor the graph as required.

Table 4-3. Graphical Tools

Plot (Y vs. X)	Description	Units	Comments
C_Q vs. V_{GS}	Quasistatic capacitance vs. gate voltage	pF vs. V	C_Q/C_{OX} optional
C_H vs. V_{GS}	High-frequency capacitance vs. gate voltage	pF vs. V	C_H/C_{OX} optional
$C_Q + C_H$ vs. V_{GS}	Quasistatic & high frequency capacitance vs. gate voltage	pF vs. V	C_H/C_{OX} , C_Q/C_{OX} optional
Q/t vs. V_{GS}	Current vs. gate voltage	pA vs. V	
G vs. V_{GS}^*	High frequency conductance vs. gate voltage	μS vs. V	
N vs. w	Doping profile vs. depth	cm^{-3} vs. μm or nm	
N vs. w	Ziegler (MCC) doping profile vs. depth	cm^{-3} vs. μm or nm	
$1/C_H^2$ vs. V_{GS}	$1/C_H^2$ vs. gate voltage	pF^{-2} vs. V	$(C_{OX}/C_H)^2$ optional
w vs. V_{GS}	Depth vs. gate voltage	μm vs. V	
D_{IT} vs. E_T	Interface trap density vs. trap energy	$cm^{-2}eV^{-1}$ vs. eV	
ψ_s vs. V_{GS}	Band bending vs. gate voltage	V vs. V	
C_Q vs. ψ_s	Quasistatic capacitance vs. band bending	pF vs. V	C_Q/C_{OX} optional
C_H vs. ψ_s	High-frequency capacitance vs. band bending	pF vs. V	C_H/C_{OX} optional

*R vs. V_{GS} for series model.

NOTE: Where indicated, plots can be normalized to C_{OX} by selecting appropriate option on menu.

4.6.2 Graphing Data

Selecting a graphing option will cause a graph to be generated on the screen, along with the graphics control window.

NOTE

A particular graph retains its configuration until a new reading array is analyzed.

The graphics control menu is shown in Figure 4-11. Through this menu you can select the following:

1. Auto Scaling. When auto scaling is selected, the minimum and maximum values for the data will automatically be used as the limits for both X and Y axes.
2. Axes Limits. This option allows you to select the minimum and maximum limits for both X and Y axes, and it can be used to zoom in on a portion of the curve. At the prompts, type in Xmin, Xmax, Ymin, and Ymax (minimum must be less than maximum). To leave a parameter unchanged, simply press Enter. See also paragraph 4.4.4 for information on using the graphics range as an alternative.
3. Plot Graph. This option dumps the complete graph including the curve and axes to the printer or plotter (depending on the selected hard copy device). Note, however, that the graphics control menu will not appear on the hard copy plot. Plot resolution and size can be controlled, as discussed below.
4. Plot Curve. Use this option to generate the curve only with the external plotter. This feature is useful for drawing more than one curve on a graph.
5. Change Notes. You can type in two lines of notes that will appear at the top of the graph by using this option. The notes will also appear on any hard copy plot made of the graph. Each line is entered separately.
6.
 - A. Normalize to C_{OX} . This option is available only when plotting C_Q or C_H vs. some other parameter such as gate voltage of band bending. When selected, the Y axis will show C/C_{OX} .
 - B. Lin/Log Graph. This option is available only for plots other than C_Q or C_H . When log is selected, the Y axis is plotted logarithmically, but the X axis remains linear. Note that absolute values are plotted using the log option.
7. Adjust Gain/Offset C_Q or C_H . Enter a new value at each prompt (see discussion below on using cursor marking).
8. Exit.

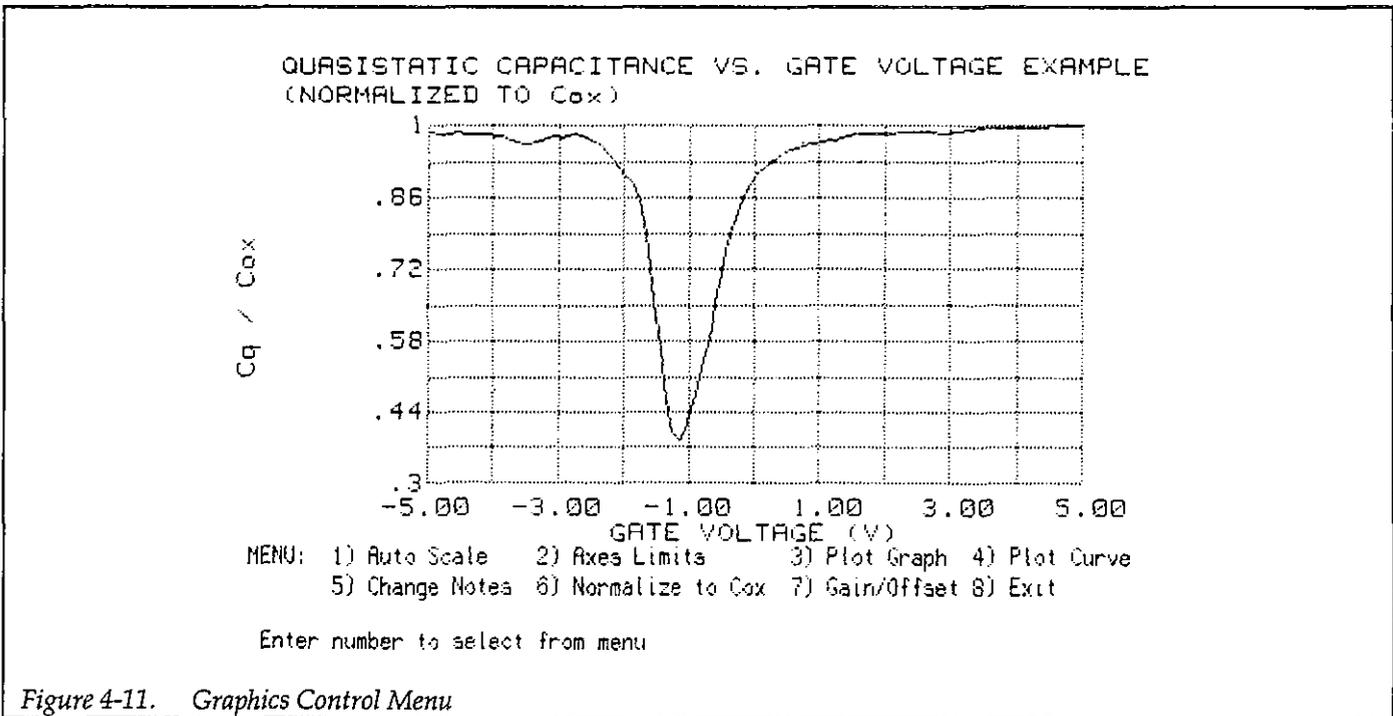

Figure 4-11. Graphics Control Menu

Printer Size and Resolution

From the graphics menu, you can control the size and resolution of your hard copy graphs made on printer by pressing one of the following letters:

- m Half page, low-resolution plot
- M Half page, high-resolution plot
- l Full page, low-resolution plot
- L Full page, high-resolution plot
- Q Abort plot and return to graphics menu

Note that selecting option 3 or 4 on the graphics menu automatically generates a half-page, low-resolution curve or graph on the printer.

Plotter Size

With a plotter, you can control the plot size. This selection will be displayed on the screen after you select the plotting option on the graphics menu.

Cursor Operation

To make it easier to change axes scales and gain and offset values, a cursor marker facility is included with Model 82-DOS. To use this feature, type "C" or "c" from the graphics menu. Once enabled, a cursor will be displayed on the screen, and you can move that cursor around the screen using the arrow keys. The value corresponding to the present cursor location will be displayed at the bottom of the screen.

To mark a specific location, press the ENTER key. The location will be marked with a set of crosshairs on the graph. Move the cursor to the second location with the cursor keys, and note that dy (change in y) and ry (ratio between present y location and marked y location) are displayed on the bottom of the screen. To mark the second location, press ENTER a second time, then press the ESC key to exit the cursor mode. Subsequently selecting the Axes Limits or Gain/Offset options will cause both markers to be displayed on the screen along with the differences between them. You can then use this information to set your new axes limits, or gain and offset values.

You can also use the Insert key to draw a line on the graph. Move the cursor the first location, then press the ENTER key to mark the point. Move the cursor to the second location, then press the Insert key to draw the line.

Overlaying Curves

When using a plotter, you can overlay a number of curves on the same graph. To use this feature, first plot the entire graph by selecting option 3 (plot graph) on the graphics control menu. Load your next data set, then generate the curve by selecting option 4 (plot curve). Repeat this process for as many curves as you wish to overlay.

Needless to say, the X and Y axis scaling factors for all sets of overlay data must be the same, or the resulting curve overlays will have minimal analytical value.

Threshold Voltage and Flatband Voltage Display

Threshold voltage and flatband voltage are automatically marked as V_{th} and V_{fb} on any graph which displays V_{GS} along the X axis. You can toggle this display on or off by pressing the "V" key.

4.6.3 Reading Array

During a voltage sweep, C_Q , C_H , G , Q/t , and V_{GS} are stored in the reading array where:

C_Q = Quasistatic capacitance

C_H = High-frequency capacitance

G = Conductance

Q/t = Current

V_{GS} = Gate voltage. Note that the substrate voltage is measured by the Model 590 and is changed to V_{GS} by negation.

Array readings are made at every other voltage step, but if the filter is on, the first four C_Q' and Q/t readings are invalid, so they are discarded.

Q/t , G , C_H , and V_H and all measured at the same point in the sweep, but C_Q' is measured one-half step V before V_H is measured. Since some calculations require that C_Q and

C_H are measured at the same voltage, C_Q' must be interpolated to C_Q as follows:

$$C_Q(i) = C_Q'(i) + \frac{C_Q'(i+1) - C_Q'(i)}{V_H(i+1) - V_H(i)} \frac{V_{STEP}}{2}$$

$$= C_Q'(i) + \frac{\Delta C_Q}{\Delta V_H} \frac{V_{STEP}}{2}$$

After interpolation, the C_Q and C_H values are adjusted according to programmed gain and offset values to determine C_{QA} and C_{HA} (adjusted C_Q and C_H). C_{QA} and C_{QH} are the values actually plotted, printed, and used in calculations.

4.6.4 Graphics Array

In order to support the analysis functions, array includes w , N , ψ_s , E_T , and D_{IT} where:

- w = Depletion depth or thickness
- N = Doping concentration
- ψ_s = Band bending
- E_T = Interface trap energy
- D_{IT} = Density of interface traps
- $1/C^2$ = High-frequency capacitance
- Ziegler w = Ziegler (MCC) depletion depth
- Ziegler N = Ziegler (MCC) doping concentration

Graphics Array Structure

The graphics array is constructed by solving for these parameters at each value of V_{GS} using C_{QA} , C_{HA} , C_{OX} , and gate area. The graphics array is recalculated each time analysis is selected on the menu, if new data has been taken, or if a reading data file is loaded from disk. If C_{OX} , t_{OX} , and gate area are not defined, the array is not calculated, and the user is notified.

Changing Device Constants

Changing C_{OX} , gate area, or t_{OX} will cause the entire graphics array to be recalculated. Changing N_{BULK} will cause C_{FB} , ψ_s , and E_T to be recalculated.

Invalid Array Values

Most of the equations used for analysis can have a situation where a divide by zero error could occur in certain circumstances (for example, if $C_H = C_{OX}$, or $C_H(i) = C_H(i+1)$). In order to avoid problems, a very high value (10^{32}) is placed in any array element where such a divide by zero error occurred. During plotting, a test for 10^{32} is done, and the pen is lifted for invalid values. As a result, the curve will be generated only over areas of valid data.

Discontinuous areas are normal with some curves because trap tests are intended only for depletion; also curves might not be properly aligned, resulting in invalid areas when plotting D_{IT} .

4.6.5 Graphing the Reading Array

Data from the reading array can be graphed by selecting the appropriate option(s) on the analysis menu. Data that can be plotted includes:

- C_{QA} vs. V_{GS}
- C_{HA} vs. V_{GS}
- Both C_{QA} and C_{HA} vs. V_{GS} on the same graph
- Q/t vs. V_{GS}
- G vs. V_{GS} (R vs. V_{GS} for series device model)

Note that compensated C_Q and C_H are the values plotted.

Examples of these graphs are shown in Figure 4-12 through Figure 4-16.

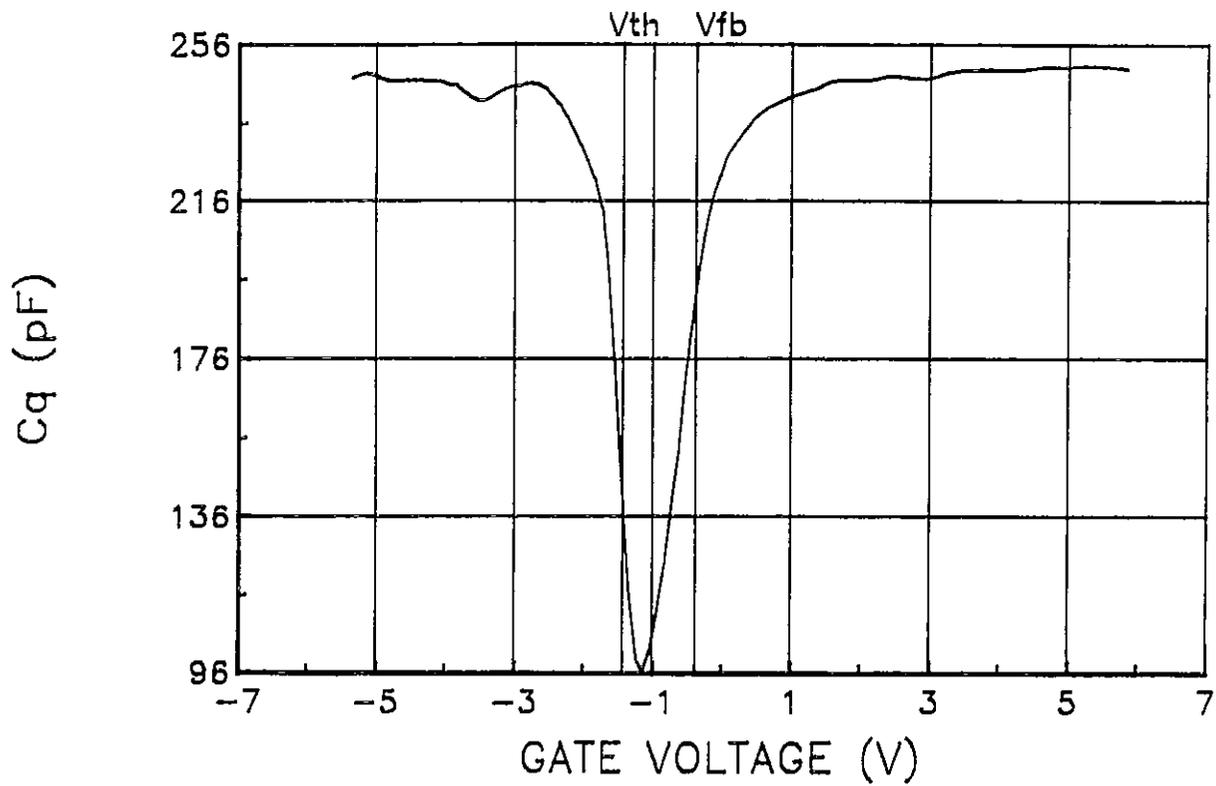

The curve data represents the low-frequency capacitance of the device under test including interface trap and inversion layer capacitance

Figure 4-12. Quasistatic Capacitance vs. Gate Voltage Example

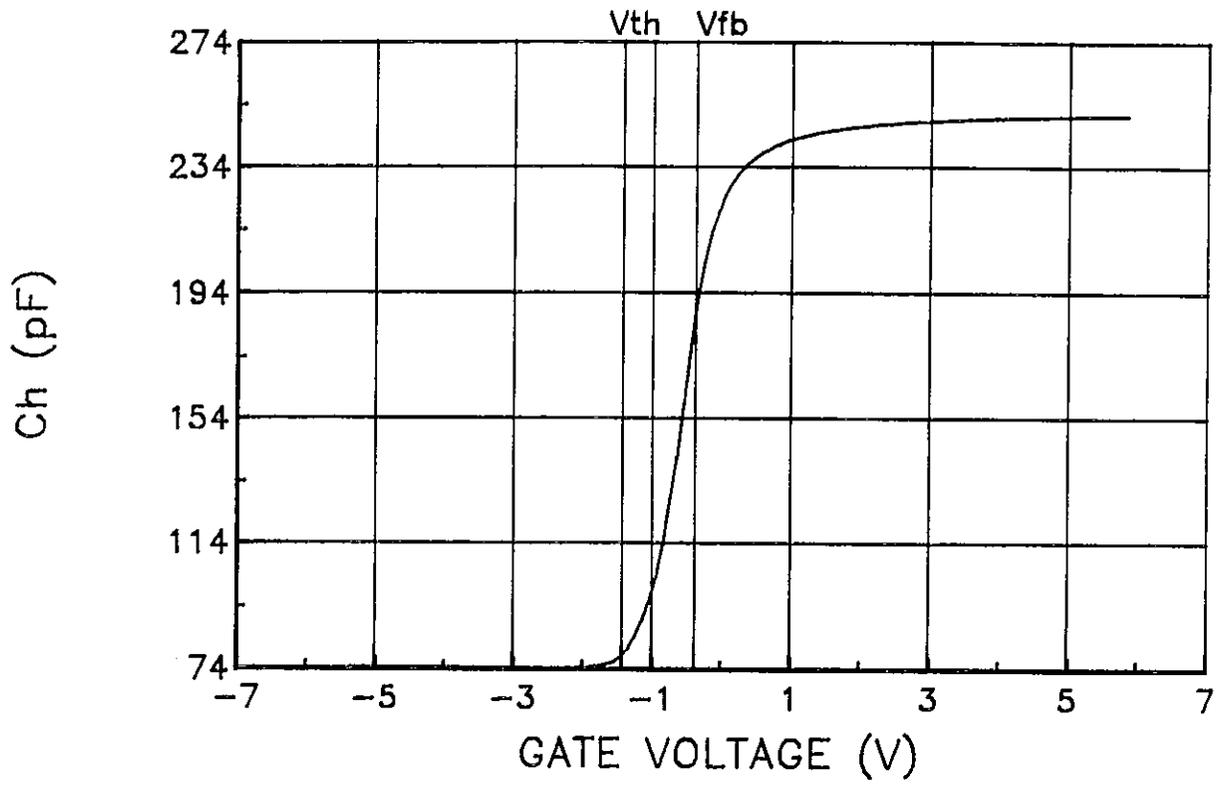

The curve data shows the high-frequency capacitance of the device under test. Interface traps and the inversion layer respond to the DC bias voltage, but do not follow the high-frequency AC test signal, resulting in reduced capacitance in inversion.

Figure 4-13. High-Frequency vs. Gate Voltage Example

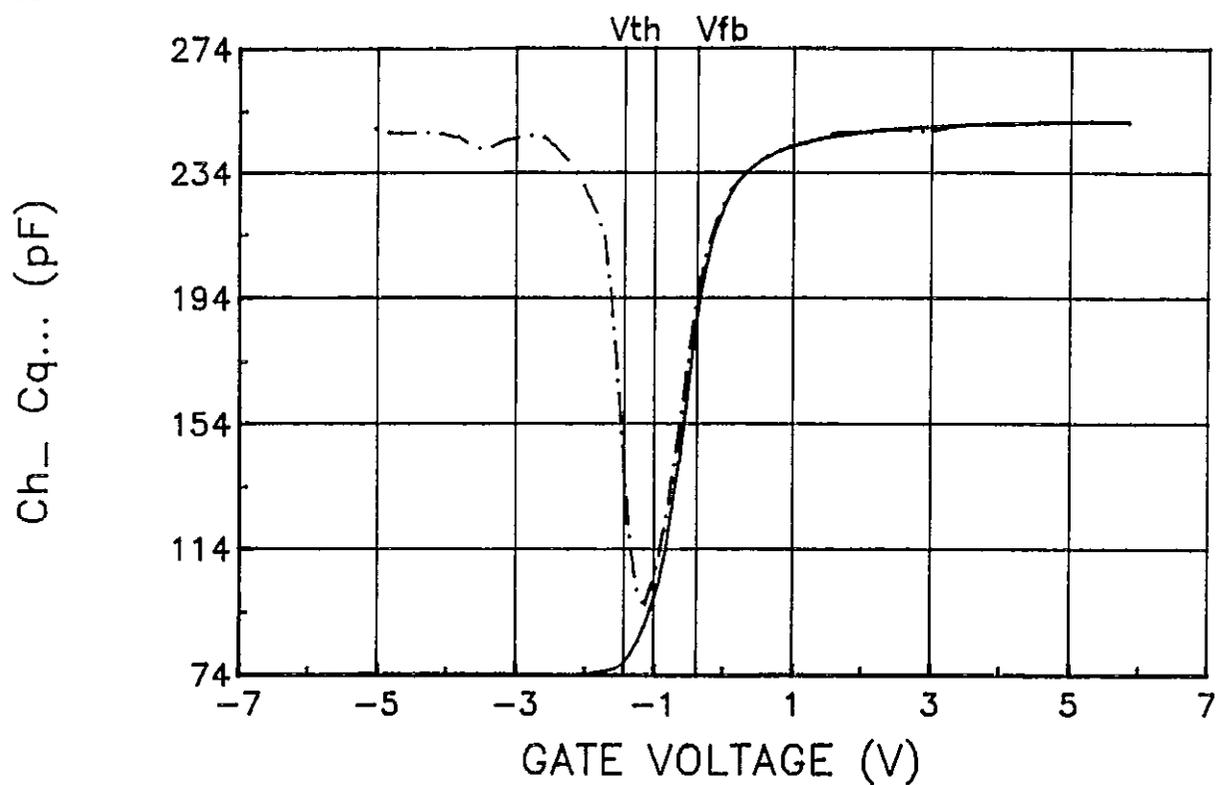

Curve differences result from such phenomena as interface charge trapping or inversion layer formation. Curve alignment errors caused by voltage stress, mobile ionic charge, and interface trap stretch-out are minimized by simultaneous C-V measurement.

Figure 4-14. High-Frequency and Quasistatic Capacitance vs. Gate Voltage Example

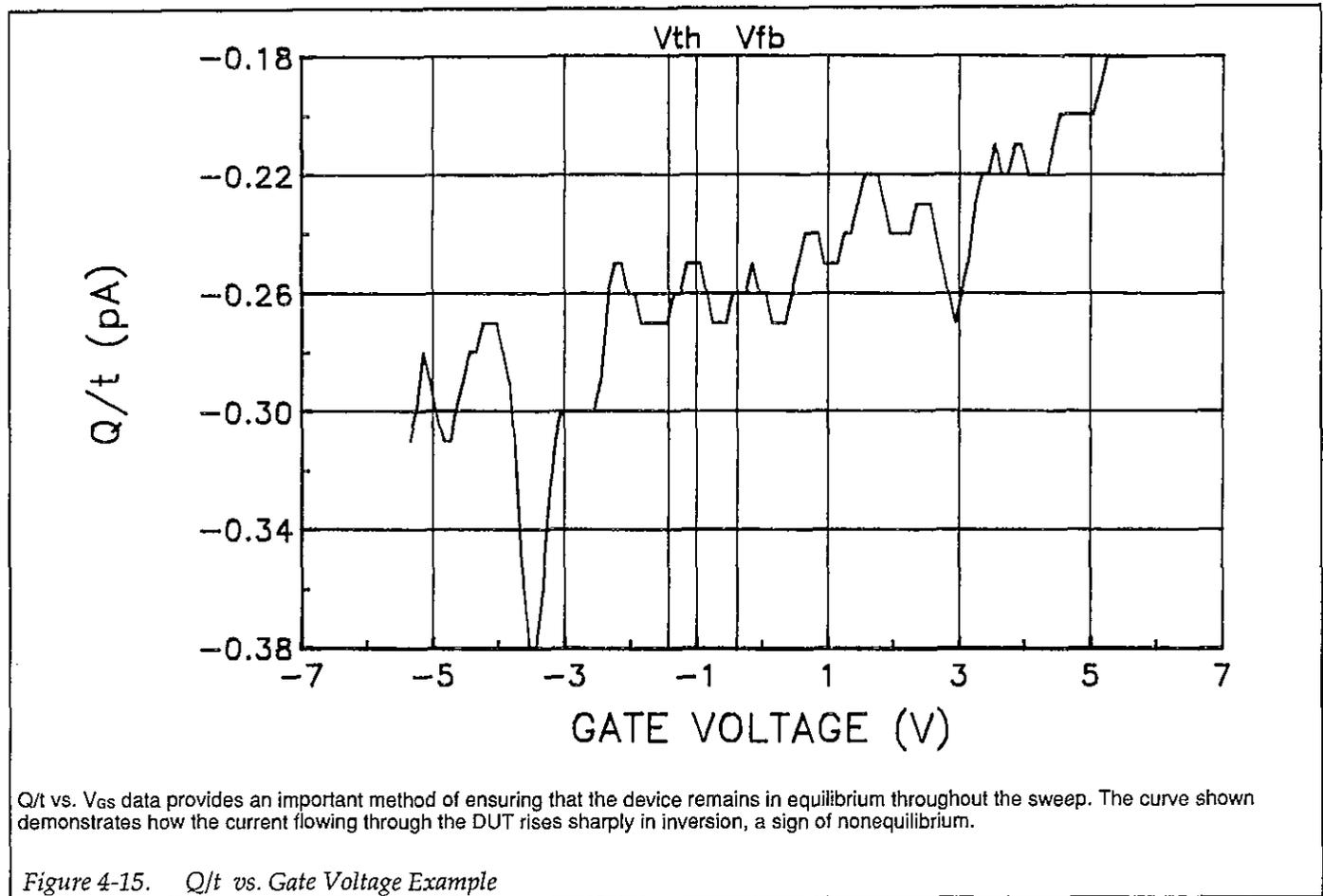

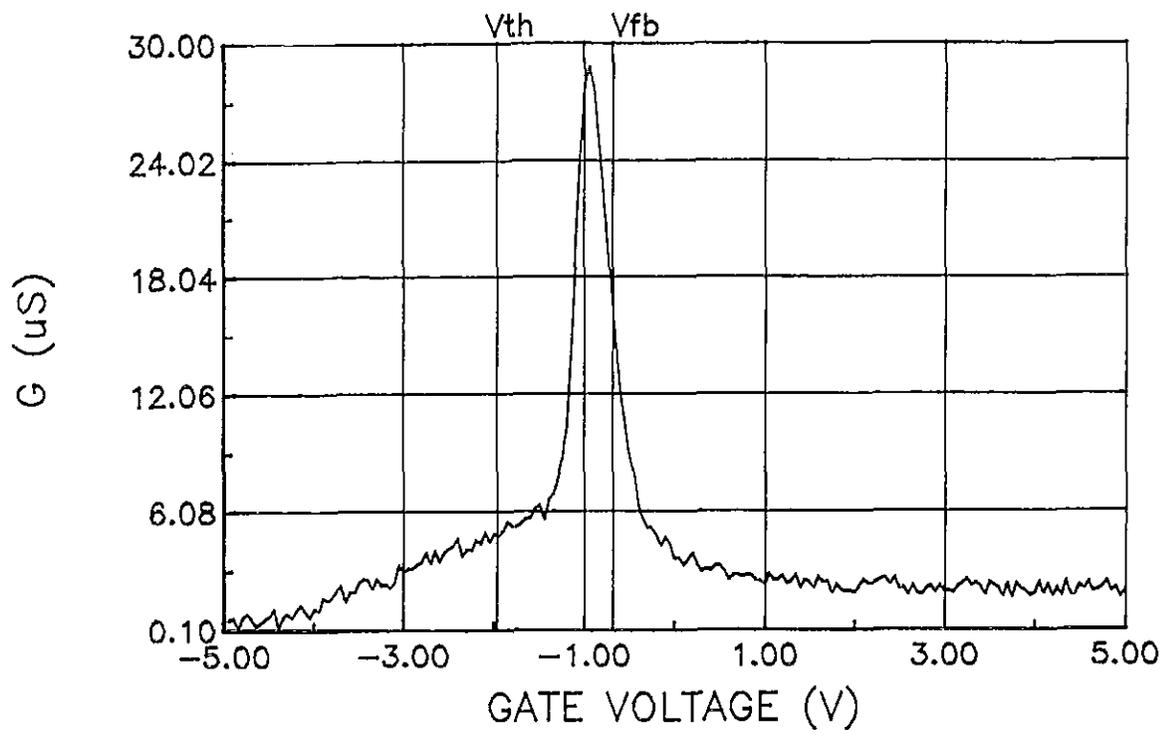

A plot of 100kHz or 1MHz conductance vs. V_{GS} shows compensation for high series resistance of the device under test. A conductance peak in the depletion region would indicate lossy interface traps.

Figure 4-16. Conductance vs. Gate Voltage Example

4.6.6 Doping Profile

Doping profile analysis includes graphing of depletion depth vs. gate voltage, doping concentration vs. depth, and $1/C^2$ vs. gate voltage, as discussed below.

Depletion Depth vs. Gate Voltage (w vs. V_{GS})

Model 82-DOS computes the depletion depth, w , from the high-frequency capacitance and oxide capacitance at each measured value of V_{GS} (Nicollian and Brews 386).

Depletion depth vs. gate voltage can be graphed by selecting the corresponding option on the analysis menu. In order to graph this function, the program computes

each element of the w column of the calculated data array as shown below.

$$w = A\epsilon_s \left(\frac{1}{C_H} - \frac{1}{C_{OX}} \right)$$

Where: w = depth (μm)
 ϵ_s = permittivity of substrate material
 C_H = high-frequency capacitance (pF)
 C_{OX} = oxide capacitance (pF)
 A = gate area (cm^2)

Figure 4-17 shows a typical example of a w vs. V_{GS} plot. The C-V curves for the device are shown in Figure 4-14.

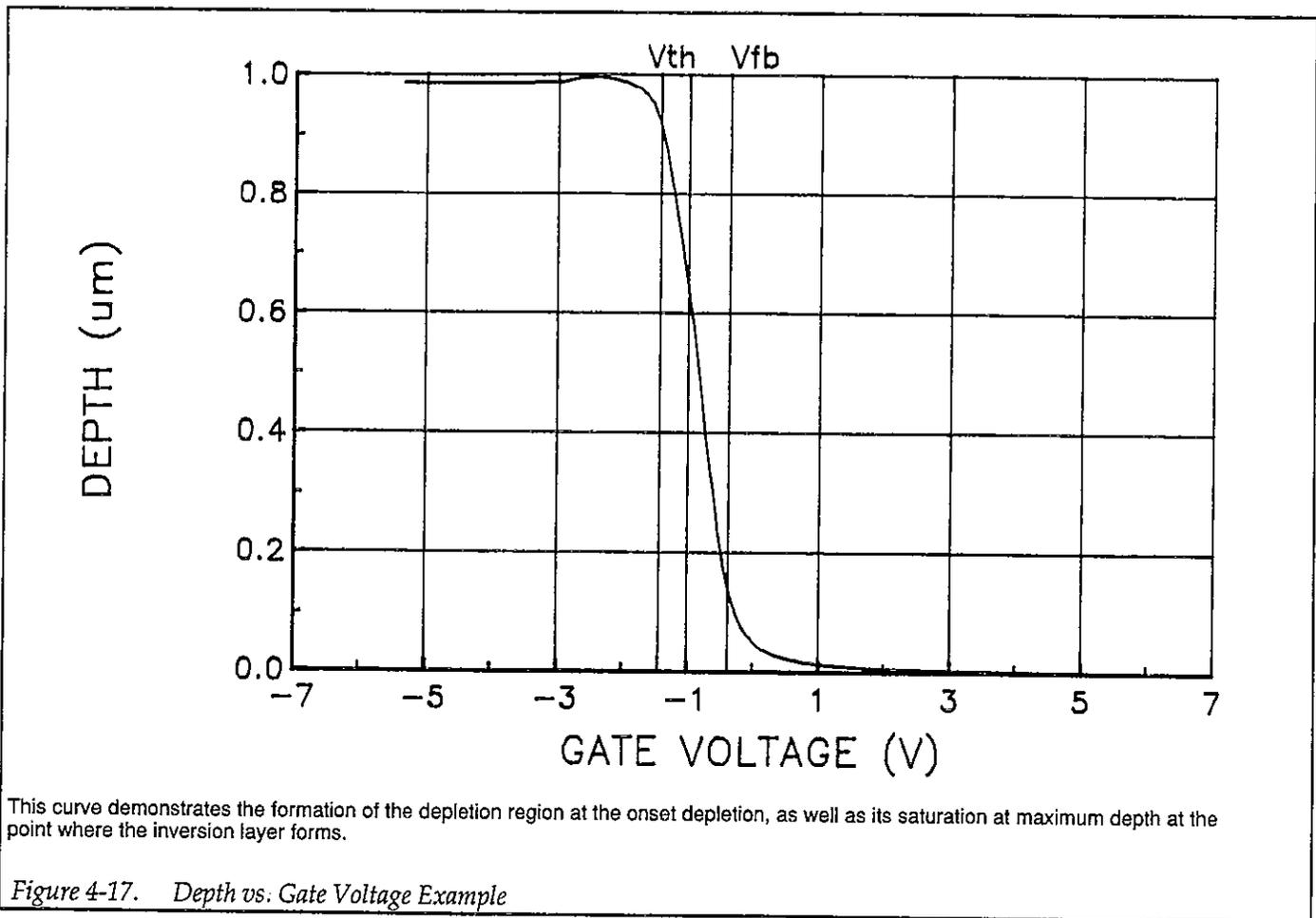

Doping Concentration vs. Depth (N vs. w)

The doping profile of the device is derived from the C-V curve based on the definition of the differential capacitance (measured by the Models 590 and 595) as the differential change in depletion region charge produced by a differential change in gate voltage (Nicollian and Brews 380-389).

The standard N vs. w analysis discussed here does not compensate for the onset of accumulation, and it is accurate only in depletion. This method becomes inaccurate when the depth is less than two Debye lengths. Refer to paragraph 4.4.7 for information on Ziegler (MCC) doping profile, which compensates for these effects.

In order to correct for errors caused by interface traps, the error term $(1-C_Q/C_{OX})/(1-C_H/C_{OX})$ is included in the calculations as follows:

$$N = \frac{(-2 \times 10^{-24})[(1-C_Q/C_{OX})/(1-C_H/C_{OX})]}{A^2 q \epsilon_s} \left[\frac{d}{dV_{GS}} \left(\frac{1}{C_H^2} \right) \right]^{-1}$$

Where: N = doping concentration (cm^{-3})
 C_Q = quasistatic capacitance (pF)
 C_{OX} = oxide capacitance (pF)
 $(1-C_Q/C_{OX})/(1-C_H/C_{OX})$ = voltage stretchout term (set to 1 in KI590.EXE program)

C_H = high-frequency capacitance (pF)
 A = gate area (cm^2)
 q = electron charge (1.60219×10^{-19} coul.)
 ϵ_s = permittivity of substrate material
 1×10^{-24} = units conversion factor

And:

$$\frac{d}{dV_{GS}} \left(\frac{1}{C_H^2} \right) \cong \frac{1/C_H^2(i+1) - 1/C_H^2(i)}{V_{GS}(i+1) - V_{GS}(i)}$$

Figure 4-18 shows an example of an N vs. w graph. Figure 4-14 shows the C-V curves of the DUT.

 $1/C^2$ vs. V_{GS}

A $1/C^2$ graph can yield important information about doping profile. N is related to the reciprocal of the slope of the $1/C^2$ vs. V_{GS} curve, and the V intercept point is equal to the flatband voltage caused by surface charge and metal-semiconductor work function (Nicollian and Brews 385).

Figure 4-19 shows a typical $1/C^2$ vs. V_{GS} plot. Data for the plot is shown in Figure 4-14.

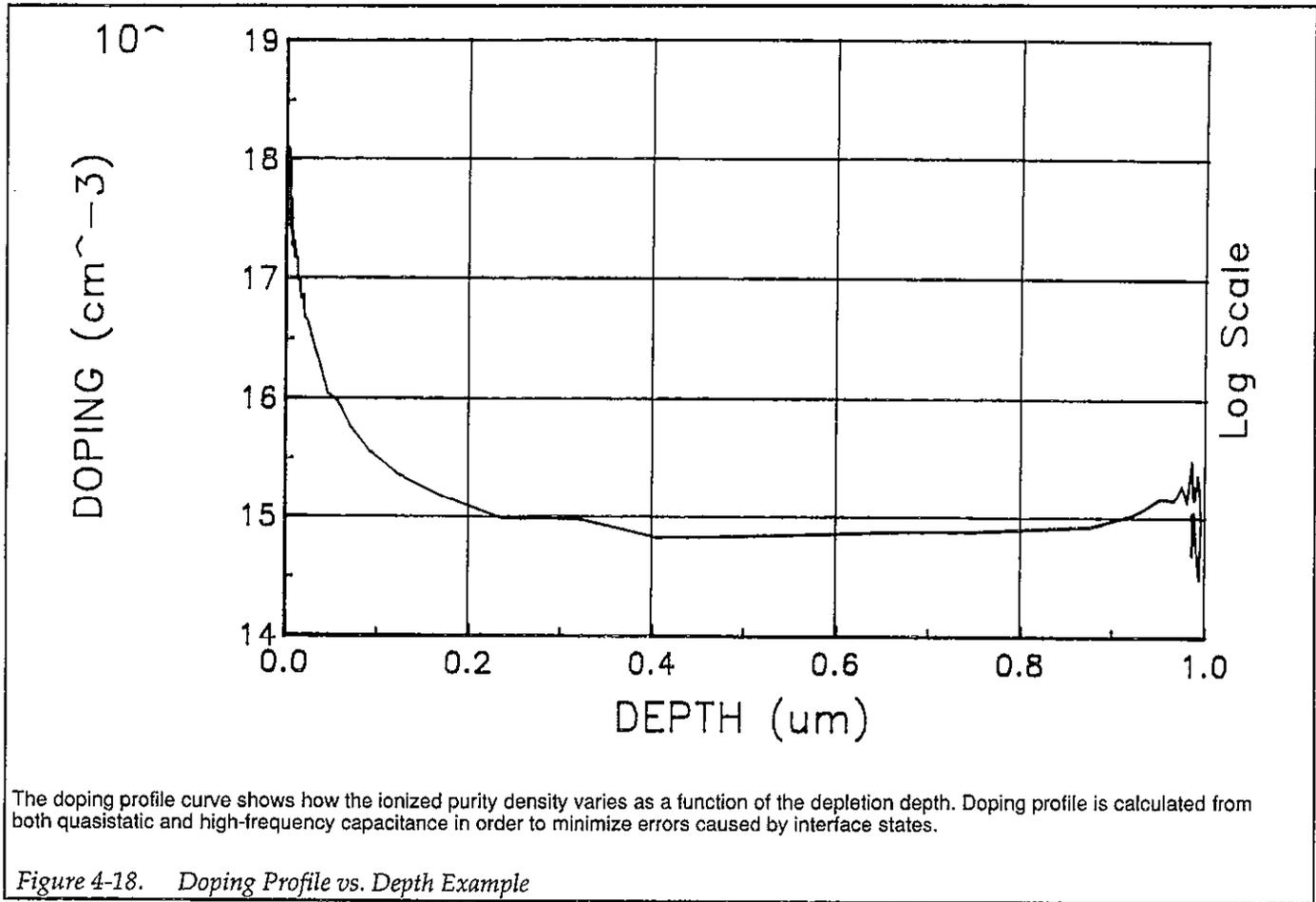

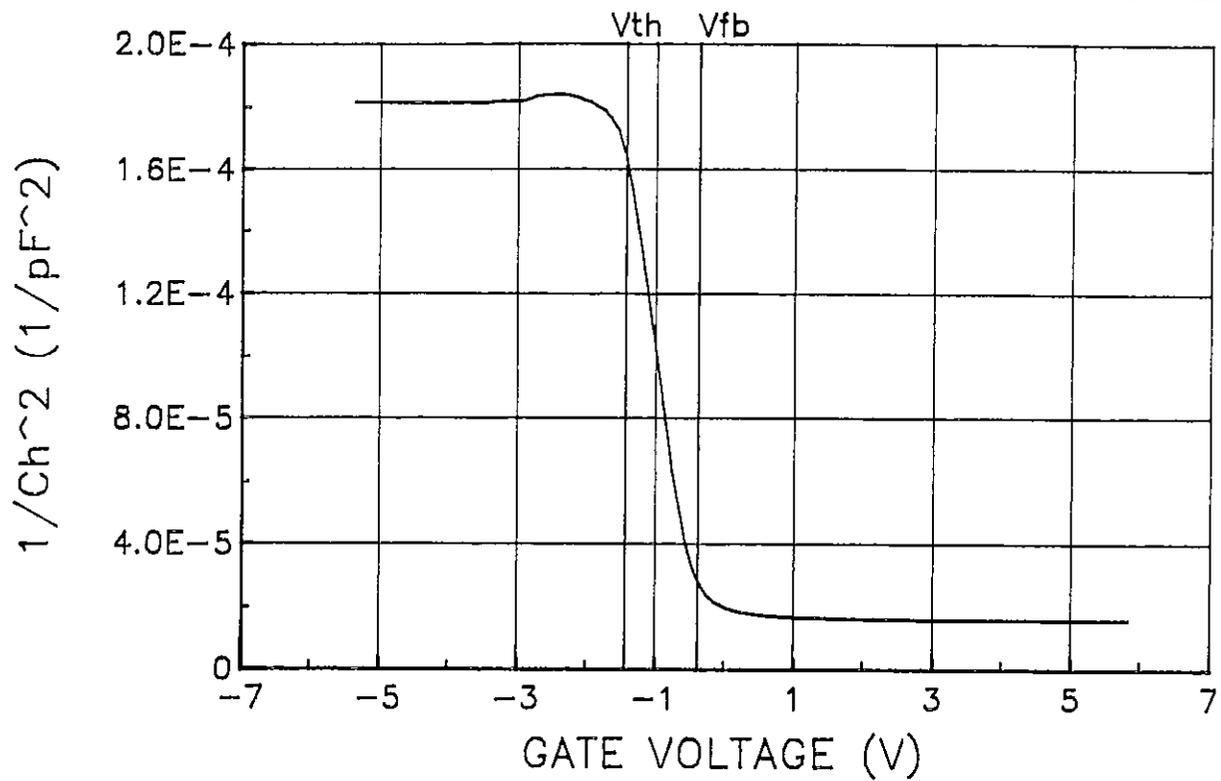

The shape of the curve is related to the doping profile in an MOS capacitor. The reciprocal of the slope of the curve at any point is proportional to the doping profile.

Figure 4-19. $1/C_H^2$ vs. Gate Voltage Example

4.6.7 Ziegler (MCC) Doping Profile

The Ziegler, or MCC (majority carrier corrected) doping profile method adjusts for the charge of the accumulation layer and compensates for errors in the doping profile calculation as the distance from the insulator becomes less than two Debye lengths. The corrected doping profile can either be graphed (selection 11 on the analysis menu), or data can be directly displayed in numerical

form (option 3 on the analysis menu). Figure 4-20 shows an example of a Ziegler N vs. w graph.

The basic algorithm used to compute the Ziegler compensated profile involves first computing a scaling factor to compensate the standard doping profile, and then calculating the new depth values based on the scaled doping profile (Ziegler et al).

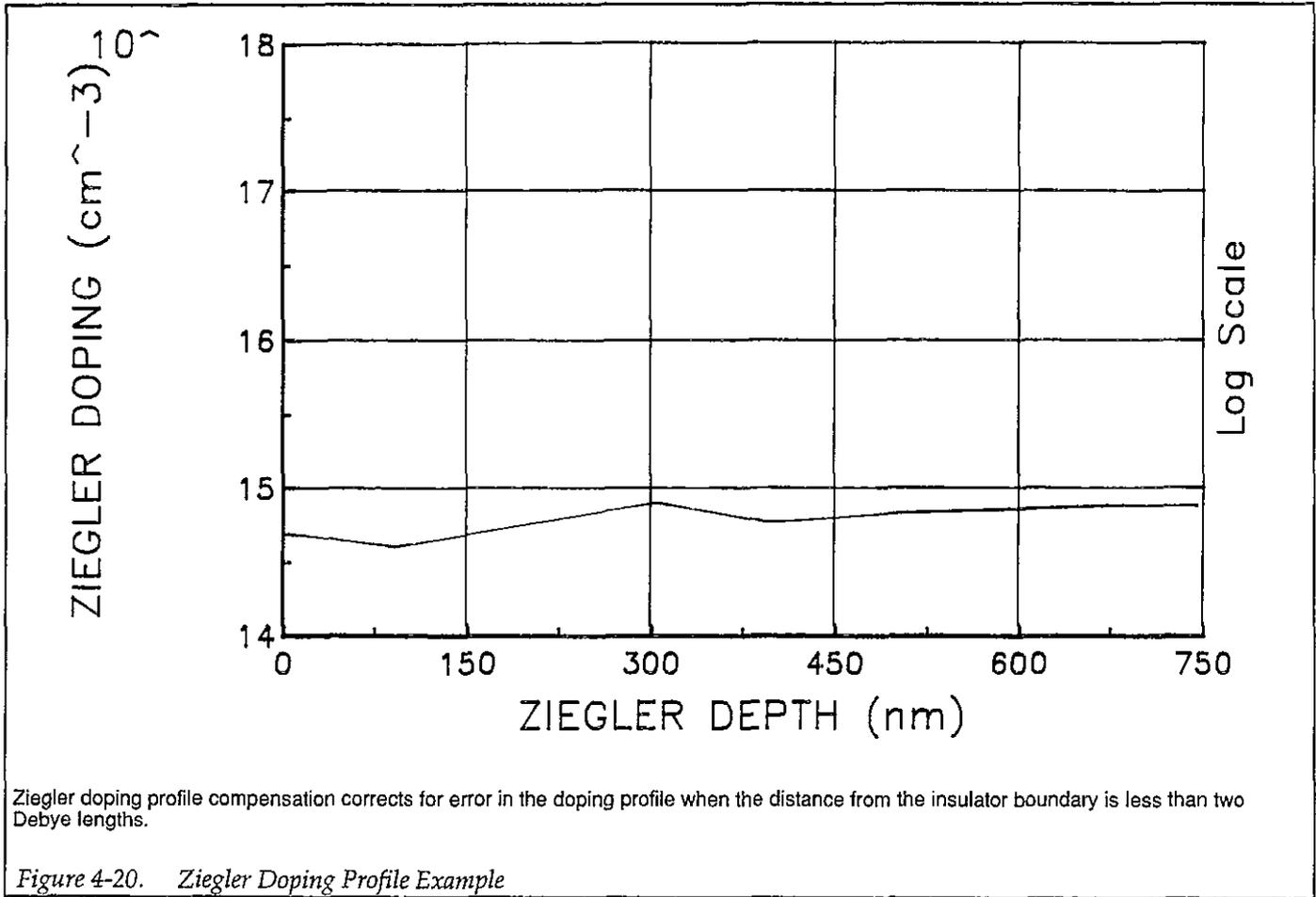

The standard doping profile is scaled as follows:

$$N(w) = \frac{(-2 \times 10^{-24}) \left[\left(1 - \frac{C_Q}{C_H} \right) / \left(1 - \frac{C_H}{C_{OX}} \right) \right]}{A^2 q \epsilon_s} \cdot \left[\frac{d}{dV_{GS}} \left(\frac{1}{C_H^2} \right) \right]^{-1} \cdot g_2 \left(\frac{w}{\lambda} \right)$$

Where: $N(w)$ = scaled doping concentration (cm^{-3})
 C_Q = quasistatic capacitance (pF)
 C_{OX} = oxide capacitance (pF)
 C_H = high-frequency capacitance (pF)
 A = gate area (cm^2)
 q = electron charge (1.60219×10^{-19} Coul.)
 ϵ_s = permittivity of substrate material
 1×10^{-24} = units conversion factor

And,

$$\frac{d}{dV_{GS}} \left(\frac{1}{C_H^2} \right) \cong \frac{1/C_H^2(i+1) - 1/C_H^2(i)}{V_{GS}(i+1) - V_{GS}(i)}$$

In the above equation, g_2 is a parameter that is derived as outlined in the following steps:

1. A parameter, g_1 , is computed from measured data as follows:

$$g_1 \left(\frac{w}{\lambda} \right) = \frac{2kT\epsilon_s}{q^2} \cdot \frac{1}{(w)^2 (N(w))}$$

where w and $N(w)$ represent the uncompensated doping profile.

2. Once g_1 is known, the equation below is solved for g :

$$g_1 \left(\frac{w}{\lambda} \right) = -2 \frac{g \left(\frac{w}{\lambda} \right)}{1 - g \left(\frac{w}{\lambda} \right)} + \frac{w^2}{\lambda^2}$$

3. g_2 can then be determined as follows:

$$g_2 \left(\frac{w}{\lambda} \right) = \frac{1}{1 - g \left(\frac{w}{\lambda} \right)} \left\{ 1 - 2 \frac{w^2}{\lambda^2} \cdot \frac{g \left(\frac{w}{\lambda} \right)}{\left[1 - g \left(\frac{w}{\lambda} \right) \right]^2} \right\}$$

Once the g_2 scaling factor is known, the compensated N values can then be computed. However, a compensated

depth, w , must also be computed for each N value. First, a new Debye length is computed as follows:

$$\lambda = \left(\frac{2kT\epsilon_s}{q^2 N(w)} \right)^{1/2}$$

Where: λ = extrinsic Debye length (cm)
 k = Boltzmann's constant (1.38066×10^{-23} J/ $^\circ\text{K}$)
 T = Test temperature ($^\circ\text{K}$)
 ϵ_s = permittivity of substrate material
 q = electron charge (1.60219×10^{-19} coul.)
 $N(w)$ = compensated doping density (cm^{-3})

Finally, the compensated depth is calculated from the new Debye length using the following relationship:

$$\frac{w}{\lambda} = (g - \ln g - 1)^{1/2}$$

4.6.8 Interface Trap Density Analysis

Interface trap density graphical analysis tools include interface trap density vs. energy, band bending vs. voltage, as well both quasistatic and high-frequency capacitance vs. band bending. In addition, flatband voltage, which is necessary to determine band bending, is also calculated as part of the analysis operation.

The C-V curve is transformed into a D_{IT} vs. E_T curve (Nicollian and Brews 319-325; Sze 379-390). This transformation is performed using the model shown in Sze (381) or Nicollian and Brews (Figure 8.1 and 8.3). The interface capacitance, C_{IT} , is the only element not in common between Figures 8.1 and 8.3 (Nicollian and Brews). However, by measuring both quasistatic and high-frequency capacitance, we can calculate its value, as discussed below.

Band Bending vs. Gate Voltage (ψ_s vs. V_{GS})

As a preliminary step, surface potential ($\psi_s - \psi_0$) vs. V_{GS} is calculated with the results placed in the ψ_s column of the array. Surface potential is calculated as follows:

$$(\psi_s - \psi_0) = \frac{V_{GS \text{ Last}}}{V_{GS \#1}} \sum (1 - C_Q/C_{OX})(2V_{STEP})$$

Where: $(\psi_s - \psi_0)$ = surface potential (V)

C_Q = quasistatic capacitance (pF)
 C_{OX} = oxide capacitance (pF)
 V_{STEP} = step voltage (V)
 V_{GS} = gate-substrate voltage (V)

Once $(\psi_s - \psi_0)$ values are stored in the array, the value of $(\psi_s - \psi_0)$ at the flatband voltage is used as a reference point and is set zero by subtracting that value from each entry in the $(\psi_s - \psi_0)$ column, changing each element in the column to ψ_s . The value of ψ_0 is interpolated as discussed below.

Note that the $(\psi_s - \psi_0)$ value is accumulated as the column is built, from the first row of the array (V_{GS} #1) to the last array row (V_{GS} last). The number of rows will, of course, depend on the number of readings in the sweep, which is determined by the Start, Stop and Step voltages.

Once band bending voltage is known, graphs of ψ_s vs. V_{GS} , C_Q vs. ψ_s , and C_H vs. ψ_s can be generated. Examples are shown in Figure 4-21 through Figure 4-23. Again, C-V curves for the device are shown in Figure 4-14.

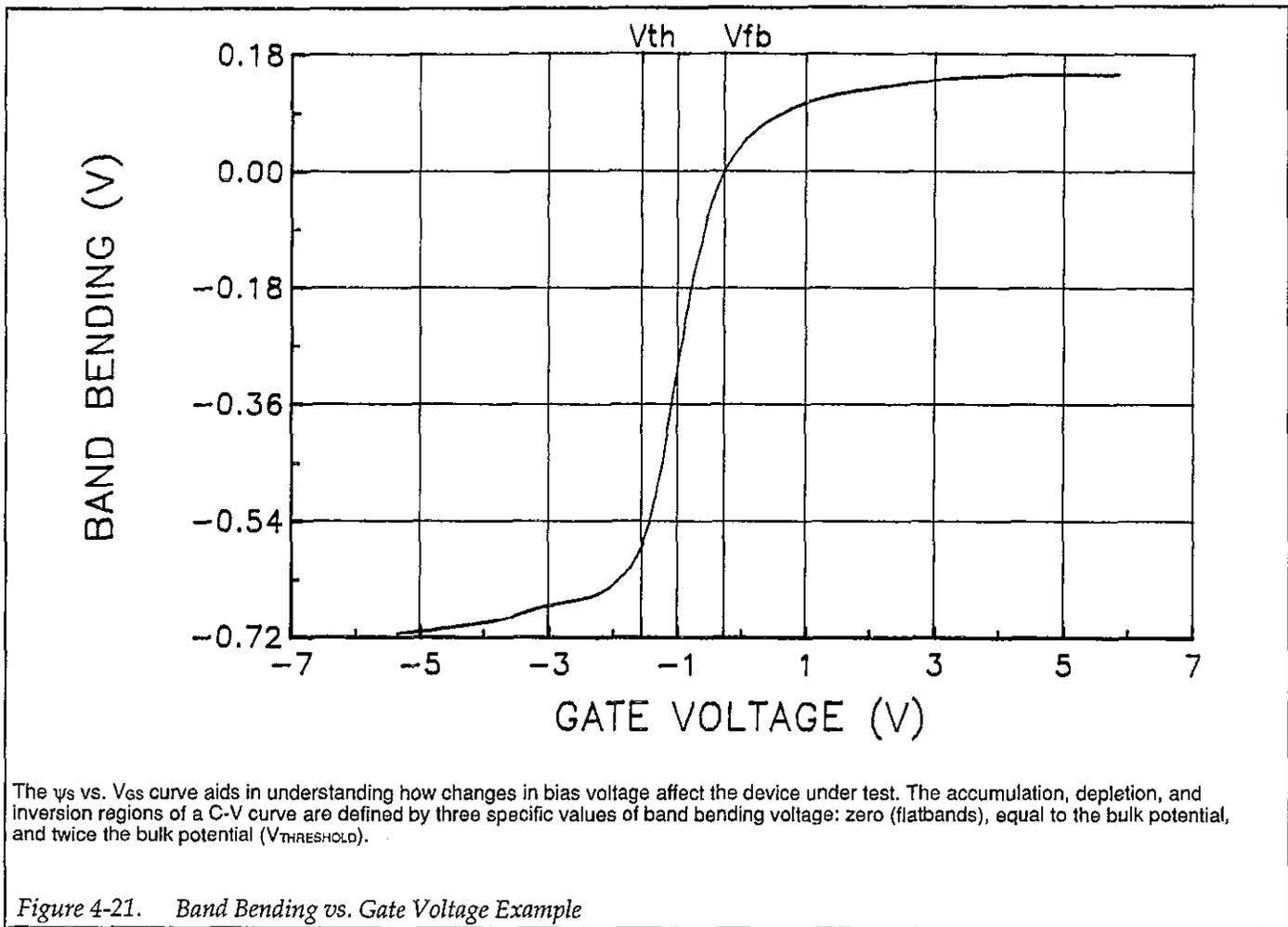

The ψ_s vs. V_{GS} curve aids in understanding how changes in bias voltage affect the device under test. The accumulation, depletion, and inversion regions of a C-V curve are defined by three specific values of band bending voltage: zero (flatbands), equal to the bulk potential, and twice the bulk potential ($V_{THRESHOLD}$).

Figure 4-21. Band Bending vs. Gate Voltage Example

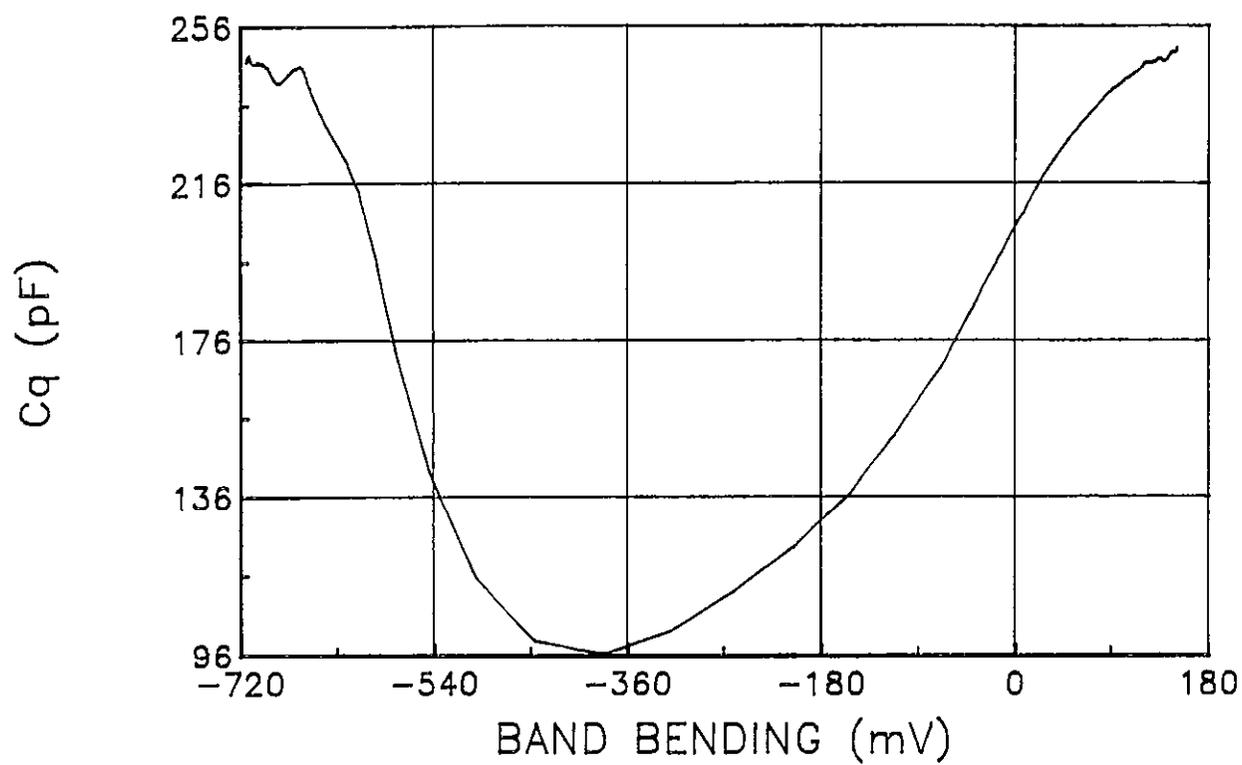

The C_Q vs. ψ_s curve aids in comparing Model 82-DOS curves with previously taken, manually aligned curves.

Figure 4-22. Quasistatic Capacitance vs. Band Bending Example

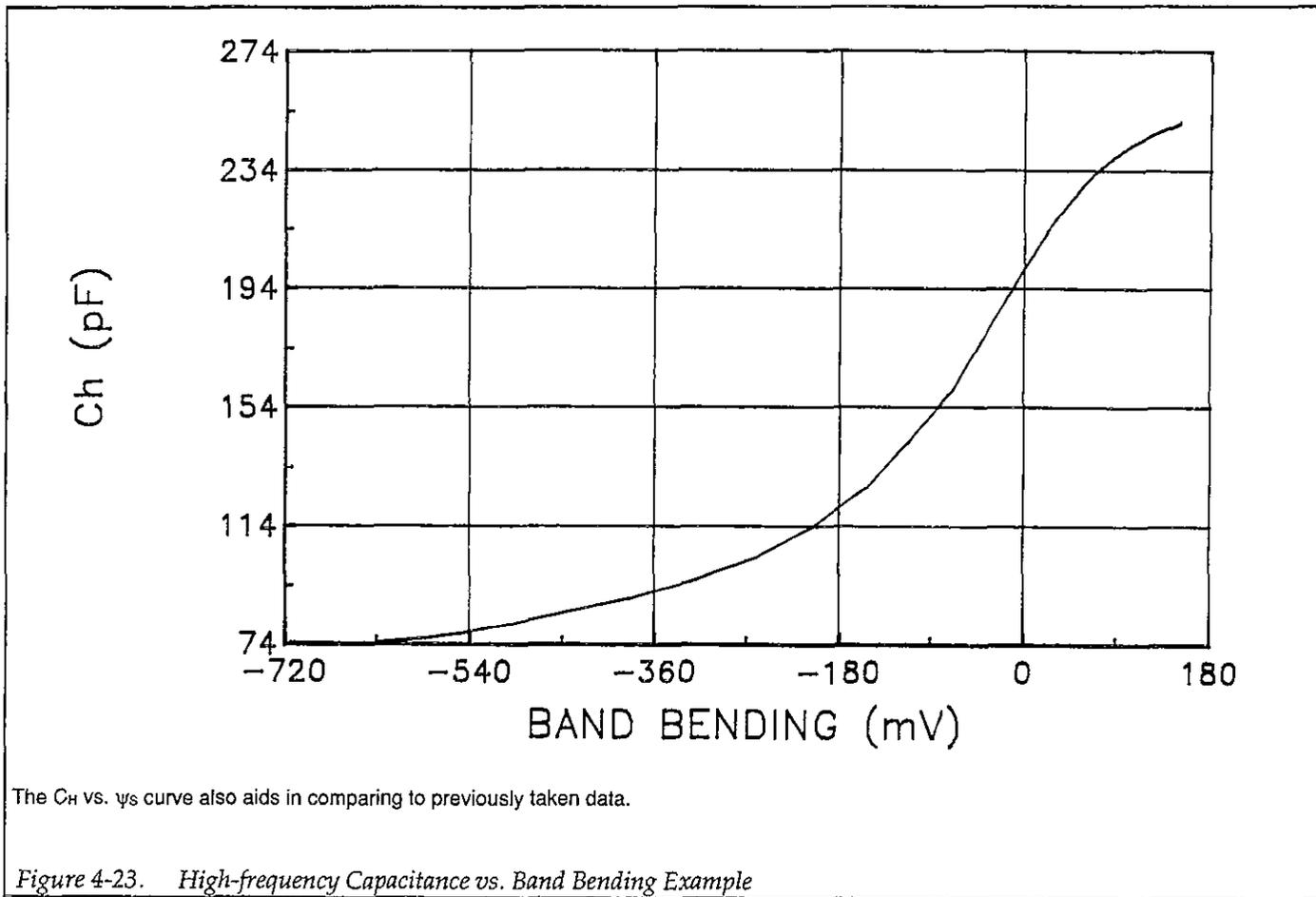

V_{FB} and ϕ_0 Interpolation

The program determines flatband voltage, V_{FB} , by locating the V_{GS} point where C_H approximately equals C_{FB} . V_{FB} is then interpolated from the closest V_{GS} values.

A straight-line interpolation from the previous or following data points is used, and the interpolated V_{FB} and ϕ_0 points are computed.

Interface Trap Density vs. Energy from Midgap (D_{IT} vs. E_T)

Interface trap density is calculated from C_{IT} as shown below (Nicollian and Brews 322).

$$C_{IT} = \left(\frac{1}{C_Q} - \frac{1}{C_{OX}} \right)^{-1} - \left(\frac{1}{C_H} - \frac{1}{C_{OX}} \right)^{-1}$$

And:

$$D_{IT} = \frac{(1 \times 10^{-12}) C_{IT}}{A_q}$$

- Where:
- C_{IT} = interface trap capacitance (pF)
 - D_{IT} = interface trap density ($\text{cm}^{-2} \text{eV}^{-1}$)
 - C_Q = quasistatic capacitance (pF)
 - C_H = high-frequency capacitance (pF)
 - C_{OX} = oxide capacitance (pF)
 - A = gate area (cm^2)
 - q = electron charge ($1.60219 \times 10^{-19} \text{C}$)
 - 1×10^{-12} = units conversion for C_{IT}

The results are stored in the D_{IT} column of the array as calculated.

Interface trap energy from midgap, E_T , is completed from ψ_s offset by bulk potential, ϕ_B as follows:

$$\psi_s - \phi_B \rightarrow E_T$$

Where: ψ_s = band bending (V)
 E_T = interface trap energy from midgap (eV)

And:

$$\phi_B = \frac{kT}{q} \ln \left(\frac{N_A}{n_i} \right)$$

Where: ϕ_B = bulk potential (eV)
 k = Boltzmann's constant ($1.38066 \times 10^{-23} \text{J}/^\circ\text{K}$)

T = Test temperature ($^\circ\text{K}$)
 n_i = intrinsic carrier concentration of material
 $N_x = N$ at 90% W_{MAX} , or N_A or N_D if entered by the user

A typical example of a D_{IT} vs. E_T plot is shown in Figure 4-24.

4.7 MOBILE IONIC CHARGE CONCENTRATION MEASUREMENT

Mobile ionic charge concentration in the oxide of an MOS device must be carefully controlled during the manufacturing process. Sodium ion concentrations are particularly important because of their abundance in the environment and the fact that they move rapidly through the oxide.

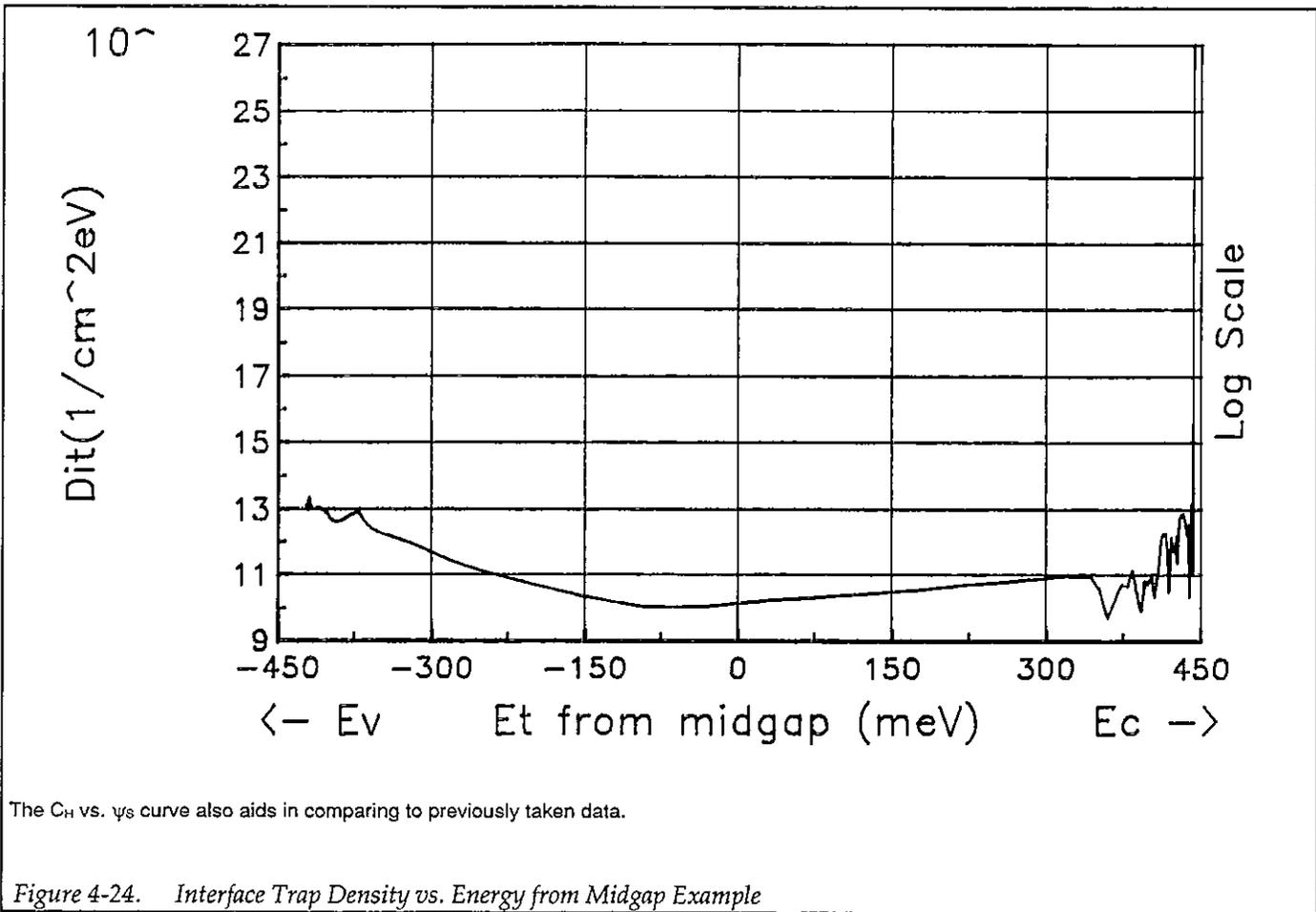

The C_H vs. ψ_s curve also aids in comparing to previously taken data.

Figure 4-24. Interface Trap Density vs. Energy from Midgap Example

NOTE

Mobile ionic charge measurement can be performed automatically using the optional Model 5958 C-V Software Utilities and appropriate equipment.

The following paragraphs discuss two methods for measuring mobile ionic charges in the oxide: the flatband voltage shift method, and the triangular voltage sweep (TVS) method.

4.7.1 Flatband Voltage Shift Method

The primary method for measuring oxide charge density is the flatband voltage shift or temperature-bias stress method (Snow et al). In this case, two high-frequency C-V curves are measured, both at room temperature. Between the two curves, the device is biased with a voltage at 200-300°C to drift mobile ions across the oxide. The flatband voltage differential between the two curves is then calculated, from which charge density can be determined.

Procedure

1. Using the Model 82-DOS program or the separate Model 590 program, measure a high-frequency C-V curve of the device at room temperature.
2. Note that flatband voltage, V_{FB} , as calculated and displayed by the program (select Display Analysis Constants on the analysis menu).
3. Raise the temperature of the DUT to 200-300°C, and apply a bias voltage of 10-20V for 3-10 minutes.
4. Return the device to room temperature, and remove the bias voltage.
5. Measure a second C-V curve of the device at room temperature.
6. Display the flatband voltage, V_{FB} , by selecting the Display Analysis Constants on the analysis menu.
7. Subtract value of V_{FB} obtained in step 6 from the value in step 2 to determine ΔV_{FB} .

Calculation

From Nicollian and Brews (426, Eq. 10.9 and 10.10), we have:

$$V_{FB} - W_{MS} = \frac{\bar{x} Q_o}{\epsilon_{OX}} = \frac{\bar{x} Q_o}{X_o C_{OX}}$$

Where: $\bar{x} Q_o$ = the first moment of the charge distribution
 \bar{x} = charge centroid
 W_{MS} = metal semiconductor work function (constant)
 ϵ_{OX} = oxide dielectric constant
 X_o = oxide thickness
 C_{OX} = oxide capacitance

So that:

$$\begin{aligned} \Delta V_{FB} &= \Delta (V_{FB} - W_{MS}) \\ &= \Delta \frac{\bar{x} Q_o}{\epsilon_{OX}} \\ &= \frac{Q_o}{C_{OX}} \Delta \frac{\bar{x}}{X_o} \end{aligned}$$

For the common case of thermally grown oxide, $\bar{x}(\text{before}) = X_o$ and $\bar{x}(\text{after}) = 0$, so that

$$\Delta V_{FB} = \frac{-Q_o}{C_{OX}}$$

where Q_o is the effective charge. Divide Q_o by the gate area to obtain mobile ion charge density per unit area.

4.7.2 Triangular Voltage Sweep Method

A second but less familiar way to measure oxide charge density is the triangular voltage sweep (TVS) method (Nicollian and Brews 435-440). There are four key advantages of the TVS method over the C-V method including:

1. Mobile ion density measurements are accurate even in cases where interface trap density levels vary substantially.
2. Different mobile ion species such as sodium and potassium can be distinguished from one another.
3. Greater sensitivity, allowing low ion densities to be detected.
4. Greater speed because only one curve is required, in addition to the fact that the device can remain heated for several measurements.

Procedure

1. Run the KI82CV or KI595CV program.
2. Connect the Model 595 to the test fixture containing the device under test.

3. Raise the temperature of the device to a temperature of 300°C, and maintain the DUT at that temperature throughout the test.
4. Perform a quasistatic measurement by sweeping from $-V_{GS}$ to $+V_{GS}$ at the required amplitudes. Keep in mind that Step V must be low enough, and T delay must be long enough so that $C_Q \cong C_{OX}$ in the absence of mobile ions.
5. Display or print out the reading array to obtain the C_Q and V_{GS} values. Calculations can be performed as outlined below.

Calculations

Although the method presented here was originally developed for the ramp technique of quasistatic measurement, the Model 595 is used to make the necessary measurement. The end result is the same: the area between the measured capacitance curve and C_{OX} indicates the charge density as shown.

$$\sum_{-V_{GS}}^{+V_{GS}} (C_{MEAS} - C_{OX}) \Delta V_{GS} = qN_M \left[\frac{\bar{x}(V_{GS})}{X_O} - \frac{\bar{x}(-V_{GS})}{X_O} \right]$$

Where: V_{GS} = gate-substrate voltage
 ΔV_{GS} = change in gate substrate voltage (V step)
 C_{MEAS} = quasistatic capacitance measured by 595
 C_{OX} = oxide capacitance
 q = electron charge
 N_M = mobile ion density
 \bar{x} = charge centroid
 X_O = oxide thickness
 Q_O = mobile ion charge

or, if the case of thermally grown oxide, the above reduces to:

$$\sum_{-V_{GS}}^{+V_{GS}} (C_{MEAS} - C_{OX}) \Delta V_{GS} = - Q_O$$

Proof of Measurement Method

An adaptation of the proof by Nicollian and Brews (437) follows. This proof describes the validity of the feedback

charge technique as applied to the TVS method for measuring oxide charge density.

Objective:

To demonstrate that mobile ion density drift at a given temperature is proportional to the area under the peak in a quasistatic C-V curve caused by ionic motion as shown below.

Assumptions:

1. Temperature is high enough ($\cong 300^\circ\text{C}$) and the staircase is slow enough ($\leq 100\text{mV/sec}$) so that $C_Q \cong C_{OX}$ in the absence of mobile ions.
2. ΔV_{GS} is in small signal range.

Model:

The model for the derivation of proof is shown in Figure 4-25.

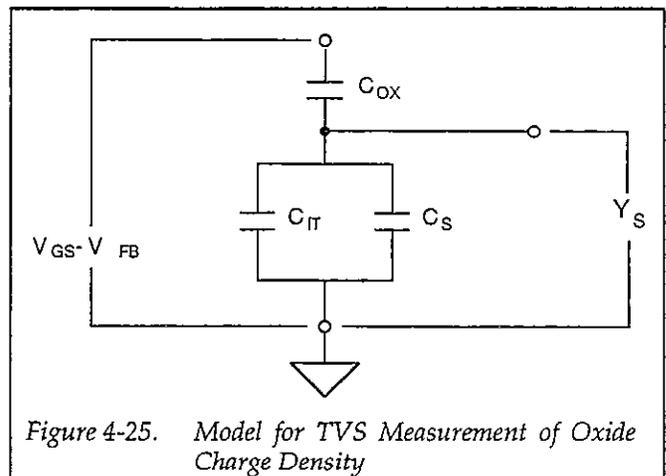

Figure 4-25. Model for TVS Measurement of Oxide Charge Density

Derivation:

The gate charge, Q_G , is made up of the following:

Eq. 1

$$Q_G = -Q_M + Q_{OT} - Q_F - Q_{IT} - Q_S$$

Where: Q_G = gate charge
 Q_{OT} = oxide trapped charge
 Q_M = mobile ionic charge
 Q_F = fixed oxide charge

Q_{IT} = interface trapped charge
 Q_s = space charge

The amounts of Q_M , Q_{OT} , and Q_F are fixed, although the distribution may change, so that,

$$\text{Eq. 2} \quad \Delta Q_G = -\Delta Q_{IT} - \Delta Q_s$$

In equilibrium,

$$\text{Eq. 3} \quad -\Delta Q_{IT} = C_{IT}(\psi_s) \Delta \psi_s$$

and,

$$\text{Eq. 4} \quad -\Delta Q_s = C_s(\psi_s) \Delta \psi_s$$

Thus, from (2), (3), and (4), we have,

$$\text{Eq. 5} \quad \Delta Q_G = (C_{IT} + C_s) \Delta \psi_s$$

From Gauss's law on the Model in Figure 4-24,

$$\text{Eq. 6} \quad (C_{IT} + C_s) \Delta \psi_s = C_{OX} [\Delta (V_{GS} - V_{FB}) - \Delta \psi_s] \\ = C_{OX} \Delta (V_{GS} - V_{FB}) - C_{OX} \Delta \psi_s$$

Rearranging (6) gives,

$$\text{Eq. 7} \quad \Delta \psi_s = \Delta (V_{GS} - V_{FB}) \frac{C_{OX}}{C_{OX} + C_{IT} + C_s}$$

In equilibrium for the model, C_Q is

$$\text{Eq. 8} \quad C_Q = C_{OX} \frac{C_s + C_{IT}}{C_{OX} + C_s + C_{IT}}$$

Combining (7) and (8) we have,

$$\text{Eq. 9} \quad \Delta \psi_s = \Delta (V_{GS} - V_{FB}) \left(\frac{C_Q}{C_s + C_{IT}} \right)$$

For assumption (1), $C_Q \cong C_{OX}$, so that

$$\text{Eq. 10} \quad \Delta \psi_s \cong \Delta (V_{GS} - V_{FB}) \left(\frac{C_{OX}}{C_s + C_{IT}} \right)$$

Rearranging (10) results in:

$$\text{Eq. 11} \quad (C_{IT} + C_s) \Delta \psi_s = C_{OX} \Delta (V_{GS} - V_{FB})$$

Using (5) and (11), and

$$C_{MEAS} = \frac{\Delta Q_G}{\Delta V_{GS}}$$

we derive,

$$\text{Eq. 12} \quad C_{MEAS} \Delta V_{GS} = \Delta Q_G = C_{OX} \Delta (V_{GS} - V_{FB})$$

Rearranging (12) yields:

$$\text{Eq. 13} \quad (C_{MEAS} - C_{OX}) \Delta V_{GS} = -C_{OX} \Delta V_{FB}$$

From assumption, 2, ΔV_{GS} is in the small signal range. If we staircase the bias voltage from $-V_{GS}$ to $+V_{GS}$, we have from (13):

$$\text{Eq. 14} \quad \sum_{-V_{GS}}^{+V_{GS}} (C_{MEAS} - C_{OX}) \Delta V_{GS} = -C_{OX} \sum_{-V_{GS}}^{+V_{GS}} \Delta V_{FB}$$

(C_{OX} is a constant)

The left-hand side of (14) represents the area under the curve caused by ionic motion:

Eq. 15

$$\underbrace{\int_{-V_{GS}}^{V_{GS}} (C_{MEAS} - C_{OX}) \Delta V_{GS}}_{\text{Area under C-V curve peak caused by ionic motion.}} = \underbrace{\int_{-V_{GS}}^{V_{GS}} C_{MEAS} \Delta V_{GS}}_{\text{Area under curve with ionic motion.}} - \underbrace{\int_{-V_{GS}}^{V_{GS}} C_{OX} \Delta V_{GS}}_{\text{Area under curve without ionic motion.}}$$

Now consider the right-hand side of (14):

Since,

$$-C_{OX} \int_{-V_{GS}}^{V_{GS}} \Delta V_{FB}$$

Eq. 19

$$Q_O = qN_M$$

$$\Delta V_{FB} = \frac{qN_M}{\epsilon_{OX}} \Delta \bar{x}$$

Where: N_M = mobile ionic charge density.

From Nicollian and Brews, (426, Eq. 10.9):

Combining (19) with (14), we have:

Eq. 16

$$V_{FB} - W_{MS} = \frac{\bar{x} Q_O}{\epsilon_{OX}}$$

Eq. 20

$$\int_{-V_{GS}}^{V_{GS}} (C_{MEAS} - C_{OX}) \Delta V_{GS} = -C_{OX} \frac{qN_M}{\epsilon_{OX}} \int_{-V_{GS}}^{V_{GS}} \Delta \bar{x}$$

Where: W_{MS} = work function ($\Delta W_{MS} = 0$)
 $\bar{x} Q_O$ = first moment of charge distribution
 \bar{x} = charge centroid
 ϵ_{OX} = dielectric constant of oxide

From Nicollian and Brews (426, Eq. 10.10),

$$C_{OX} = \frac{\epsilon_{OX}}{x_O}$$

Thus, we have,

and defining $\bar{x}(-V_{GS})$ and $\bar{x}(V_{GS})$ as \bar{x} at $-V_{GS}$ and $+V_{GS}$ respectively, we conclude:

Eq. 17

$$\Delta(V_{FB} - W_{MS}) = \Delta \frac{\bar{x} Q_O}{\epsilon_{OX}}$$

Eq. 21

$$\underbrace{\int_{-V_{GS}}^{V_{GS}} (C_{MEAS} - C_{OX}) \Delta V_{GS}}_{\text{Area under C-V curve peak caused by ionic motion.}} = -qN_M \underbrace{\left[\frac{\bar{x}(V_{GS})}{x_O} - \frac{\bar{x}(-V_{GS})}{x_O} \right]}_{\text{Mobile ion density drifted at given temperature.}}$$

but W_{MS} , Q_O , and ϵ_{OX} are constants, so:

Eq. 18

$$\Delta V_{FB} = \frac{Q_O}{\epsilon_{OX}} \Delta \bar{x}$$

Conclusion: Equation 21 demonstrates the validity of the $C_{MEAS} + \Delta Q_G / \Delta V_{GS}$ method for the TVS measurement of mobile ion drift.

4.7.3 Using Effective Charge to Determine Mobile Ion Drift

The flatband voltage method of determining mobile ion drift discussed in paragraph 4.5.1 can be simplified by using Q_{EFF} to determine the ion charge. The basic procedure is as follows:

1. Using the Model 82-DOS or separate Model 590 program, measure a high-frequency C-V curve of the device at room temperature.
2. Note the effective charge, Q_{EFF} , as calculated and displayed by the program (select Display Analysis Constants on the analysis menu).
3. Raise the temperature of the DUT to 200-300°C, and apply a bias voltage of 10-20V for 2-10 minutes.
4. Return the device to room temperature and remove the bias voltage.
5. Measure a second C-V curve of the device at room temperature.
6. Display the effective oxide charge by selecting Display Analysis Constants on the analysis menu.
7. Subtract the value of Q_{EFF} obtained in step 6 from that obtained in step 2 to determine the effective mobile ion charge density. Note that this procedure assumes the simple case of mobile ions drifting completely across the oxide in a thin sheet. See paragraph 4.5.1 for a description of the general case.

4.8 REFERENCES AND BIBLIOGRAPHY OF C-V MEASUREMENTS AND RELATED TOPICS

4.8.1 References

The references below are cited in Section 4.

1. Nicollian, E.H. and Brews, J.R., MOS Physics and Technology. Wiley, New York (1982).
2. Ziegler, K., Klausmann, E. and Kar, S., "Determination of the Semiconductor Doping Profile Right up to its Surface Using the MIS Capacitor", *Solid-State Elec.* 18, 189 (1975).
3. Sze, S.M., Physics of Semiconductor Devices, 2nd edition. Wiley, New York (1985)
4. Snow, E.H. Grove, A.S., Deal, B.E., and Sah, C.T. J., "Ionic Transport Phenomena in Insulating Films", *Appl. Phys.*, 36, 1664 (1965)

4.8.2 Bibliography of C-V Measurements and Related Topics

I. Texts:

- A. Grove, A.S., Physics and Technology of Semiconductor Devices. Wiley, New York (1967).
- B. Sze, S.M., Semiconductor Devices, Physics and Technology. Wiley, New York (1985).

II. Articles and Papers:

- A. Feedback Charge Method
 - a. Mego, T.J. "Improved Feedback Charge Method for Quasistatic CV Measurements in Semiconductors". *Rev. Sci. Instr.* 57, 11 (1986).
 - b. Mego, T.J. "Improved Quasistatic CV Measurement Method for MOS". *Solid State Technology*, 29, 11, S19-21 (1986).
 - c. Markgraf, W., Baumann, M., Beyer, A., Arst, P., Rennau, M., "Nutzung der statischen CU-Methode im Rahmen eines mikrorechnergesteuerten MOS-Messplatzes", *Phys. d. Halbleiteroberflaeche*. 15, 73 (1984).
- B. Q-V/Static Method
 - a. Ziegler, K. and Klausmann, E., "Static Technique for Precise Measurements of Surface Potential and Interface State Density in MOS Structures", *Appl. Phys. Lett.* 26, 400 (1975).
 - b. Kirov, K., Alexandrova, S., and Minchev, G., "Error in Surface State Determination Caused by Numerical Differentiation of Q-V Data", *Solid State Electronics*. 18, 341 (1978).
- C. Q-C Method and Simultaneous High-Low Frequency C-V
 - a. Nicollian, E.H. and Brews, J.R., "Instrumentation and Analog Implementation of the Q-C Method for MOS Measurements", *Solid State Electronics*. 27, 953 (1984).
 - b. Boulin, D.M., Brews, J.R., and Nicollian, E.H., "Digital Implementation of the Q-C Method for MOS Measurements", *Solid State Electronics*. 27, 977 (1984).
 - c. Derbenwick, G.F., "Automated C-V and $|Y|^{-w}$ Curves for MOS Device Analysis", Sandia Report SAND80-1308 (1982).
 - d. Lubzens, D., Kolodny, A., and Shacham-Diamond, Y.J., "Automated Measurement and Analysis of MIS Interfaces in Narrow-Bandgap Semiconductors," *IEEE transactions on Electron Devices*, ED-28, 5 (1981).

- D. Ramp Method
- a. Kuhn, M., "A Quasistatic Technique for MOS C-V and Surface State Measurements", *Solid State Electronics*. 13, 873 (1970).
 - b. Castagne, R., "De'termination de la densite' d'e'tats lents d'une capacite' me'tak-isolant semiconducteur par l'e'tude de la charge sous une tension croissant line 'airement", *C.R.Acad. Sci.* 267, 866 (1968).
 - c. Kerr, D.R., "MIS Measurement Technique Utilizing Slow Voltage Ramps", *Int.Conf. Properties and Use of MIS Structures*, Grenoble, France, 303 (1969).
 - d. Castagne, R, and Vapaille, A., "Description of the SiO₂-Si Interface Properties by Means of Very Low Frequency MOS Capacitance Measurements", *Surface Science*, 28, 157 (1971).
 - e. Kuhn, M. and Nicollian, E.H., "Nonequilibrium Effects in Quasi-static MOS Measurements", *J. Electrochem.Soc.*, 118, 373 (1971).
 - f. Lopez A.D., "Using the Quasistatic Method for MOS Measurements", *Rev.Sci.Instr.* 44, 200 (1973).
- E. Interface States/Doping Profiles
- a. Berglund, C.N., "Surface States at Steam-Grown Silicon-Silicon Dioxide Interfaces", *IEEE Trans.Electron.Dev.*, 13, 701 (1966).
 - b. DeClerck, G., "Characterization of Surface States at the Si-SO₂ Interface", *Nondestructive Evaluation of Semiconductor Materials and Devices* (J.N. Zemel, ed.) Plenum Press, New York, p. 105 (1979).
 - c. Brews, J.R., "Correcting Interface-State Errors in MOS Doping Profile Determinations", *J.Appl. Phys.* 44, 3228 (1973).
 - d. Gordon, B.J., "On-Line Capacitance-Voltage Doping Profile Measurement of Low-Dose Ion Implants", *IEEE Trans. Dev.*, ED-27, 12 (1980).
 - e. VanGelder, W., and Nicollian, E.H., "Silicon Impurity Distribution as Revealed by Pulsed MOS C-V Measurements", *J. Electrochem, Soc. Solid State Science*, 118, 1 (1971).
- F. MOS Process Characterization
- a. Zaininger, K.H. and Heiman, F.P., "The C-V Technique as an Analytical Tool", *Solid State Technology*. 13:5-6 (1970).
 - b. McMillian, L., "MOS C-V Techniques for IC Process Control", *Solid State Technology*. 15, 47 (1972).
 - c. Zerbst, M., "Relaxationseffekte an Halbleiter-Isolator-Grenzflaechen", *Z.Angew.Phys.* 22, 30 (1966).

SECTION 5

Principles of Operation

5.1 INTRODUCTION

This section discusses fundamental operating principles for the Model 82-DOS system and is arranged as follows:

- 5.2 **System Block Diagram:** Presents an overview of the system from a block diagram perspective.
- 5.3 **Remote Input Coupler:** Covers operation of the Model 5951 Remote Input Coupler.
- 5.4 **Quasistatic C-V:** Outlines fundamental principles for low-frequency measurements using the Model 595 Quasistatic C-V Meter.
- 5.5 **High-frequency C-V:** Shows fundamental operation of the system when making 100kHz and 1MHz C-V measurements.
- 5.6 **Simultaneous C-V:** Discusses the basic simultaneous C-V cycle.

5.2 SYSTEM BLOCK DIAGRAM

Figure 5-1 shows a block diagram of the Model 82-DOS system. The various components in the system perform the following functions.

Model 230-1 Programmable Voltage Source: Provides a DC offset bias voltage of up to $\pm 100V$, and also controls 100kHz/1MHz frequency selection of the input coupler.

Model 590 C-V Analyzer: Supplies a 100kHz or 1MHz, 15mV RMS test signal to the device under test, and measures high frequency capacitance and conductance.

Model 595 Quasistatic C-V Meter: Sources the sweep voltage to the device under test, measures low frequency capacitance and device currents, and also triggers Model 590 readings.

Model 5951 Remote Input Coupler: Connects the device under test to the Models 590 and 595. Internal circuitry ensures minimal interaction between instruments when making both low- and high-frequency measurements.

Computer (IBM AT, PS/2 or compatible): Controls the Models 230-1, 590, 595, and (indirectly through Model 230-1) 5951.

5.3 REMOTE INPUT COUPLER

A simplified schematic of the Model 5951 is shown in Figure 5-2.

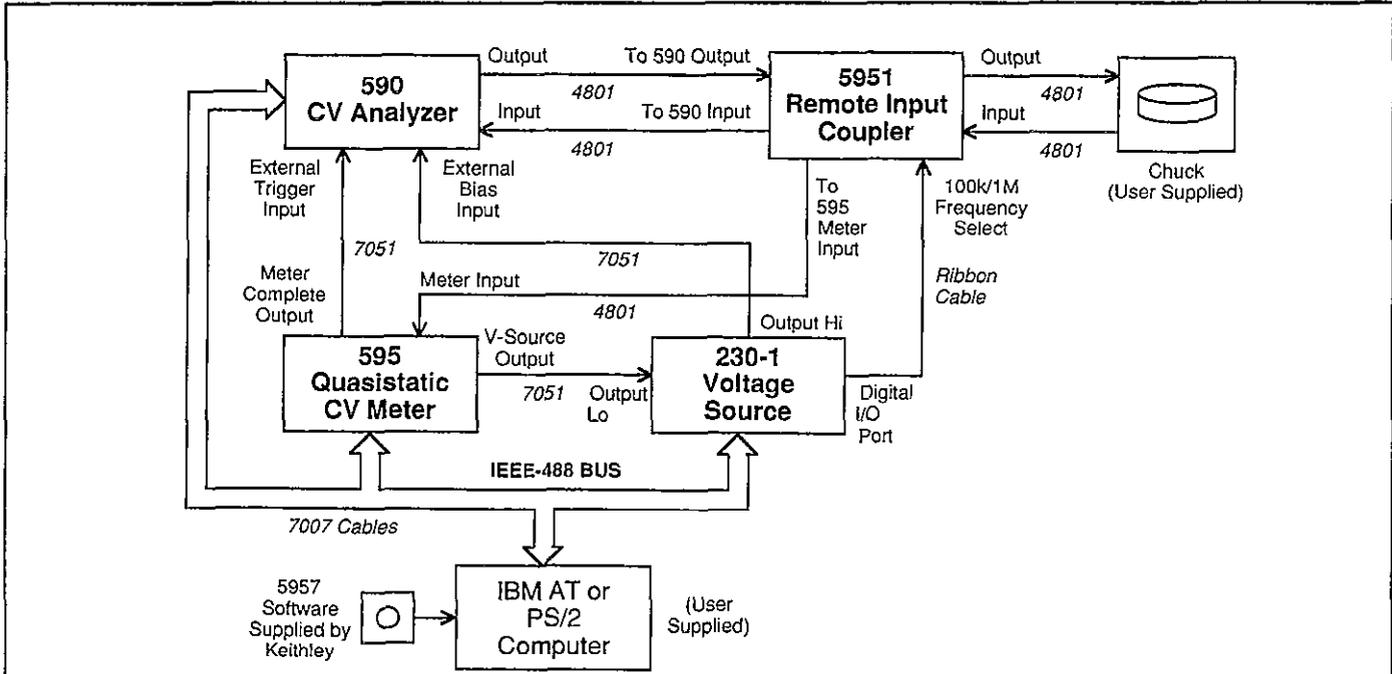

Figure 5-1. Model 82-DOS System Block Diagram

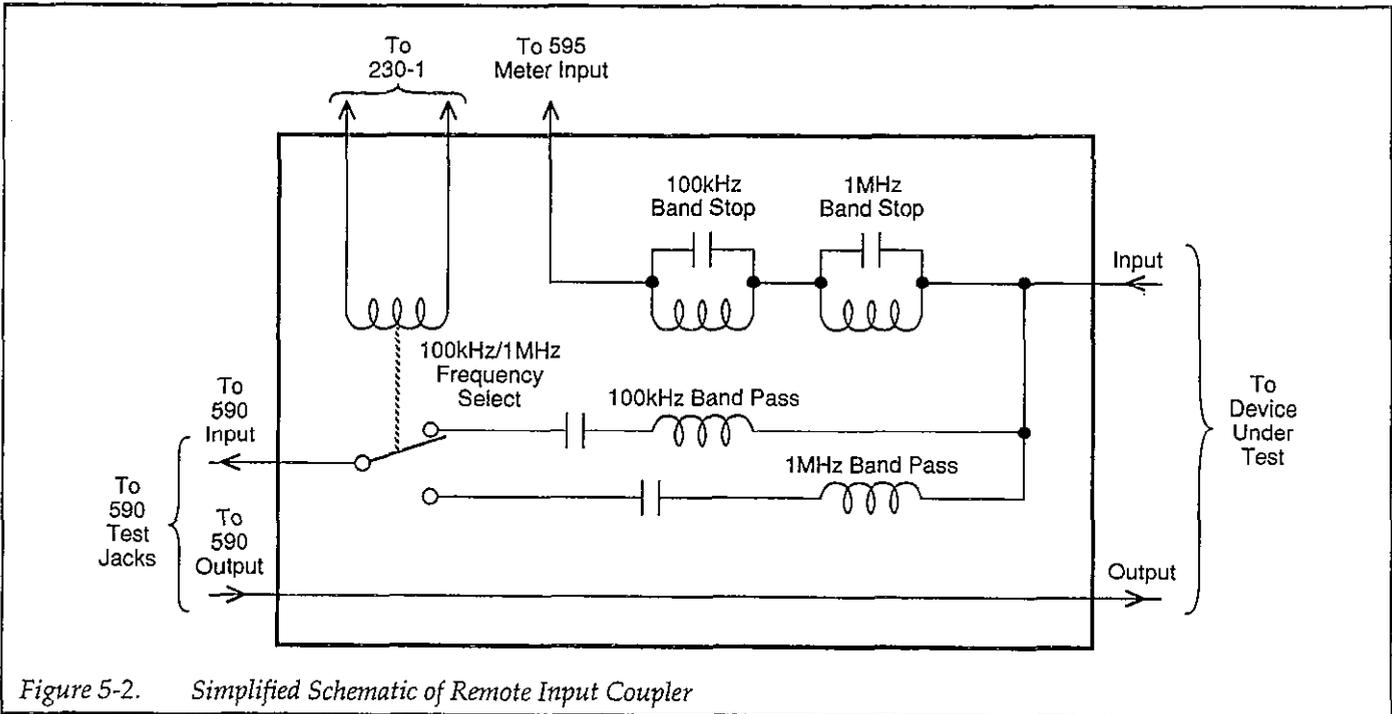

Figure 5-2. Simplified Schematic of Remote Input Coupler

5.3.1 Tuned Circuits

Two sets of tuned circuits are used to pass or trap out the 100kHz and 1MHz test signals. L1 and C1, and L2 and C2 on the AC blocking board form two parallel resonant circuits to block the 100kHz and 1MHz test signals from, and provides a DC path to the Model 595 input.

Meanwhile, two series resonant circuits allow passage of the 100kHz and 1MHz test signals to the Model 590 input while blocking DC. The series resonant circuit made up of L4, C2, C3, and C6 is tuned to 100kHz, while the series resonant circuit made up of L5, C4, C5, and C7 is tuned to 1MHz.

5.3.2 Frequency Control

A digital control signal, supplied by the Model 230-1, controls 100kHz or 1MHz operation of the Model 5951. This signal is applied to J8, buffered by elements of U2, and then coupled through opto-isolator U1 in order to maintain isolation between analog and digital circuits. The frequency select signal controls Q1, which switches relay K1 to select 100kHz or 1MHz operation.

5.4 QUASISTATIC C-V

5.4.1 Quasistatic C-V Configuration

A simplified block diagram of the Model 82-DOS system when making low-frequency (quasistatic) C-V measurements is shown in Figure 5-3. The Model 595 bias voltage is applied through the Models 590 and 5951 to the device under test. When a step voltage is applied, the unit measures the change in charge and then computes the capacitance, as discussed below.

Additional bias offset voltage of up to $\pm 100V$ DC can be applied by the Model 230-1 Voltage Source. Note that this voltage is placed in series with the Model 595 voltage source, and the source voltage is routed through the Model 590 (even though that instrument is not used for low-frequency C-V measurements) to superimpose the 15mV, 100kHz, or 1MHz test signal on the DC bias, so that both signals can be simultaneously applied to the DUT.

5.4.2 Measurement Method

The Model 595 uses the feedback charge method for making capacitance measurements. As shown in Figure 5-4, one terminal of the unknown capacitance, C_x , is connected to the voltage source, while the other terminal is connected to the inverting input of the feedback charge amplifier, A, which is an integrator.

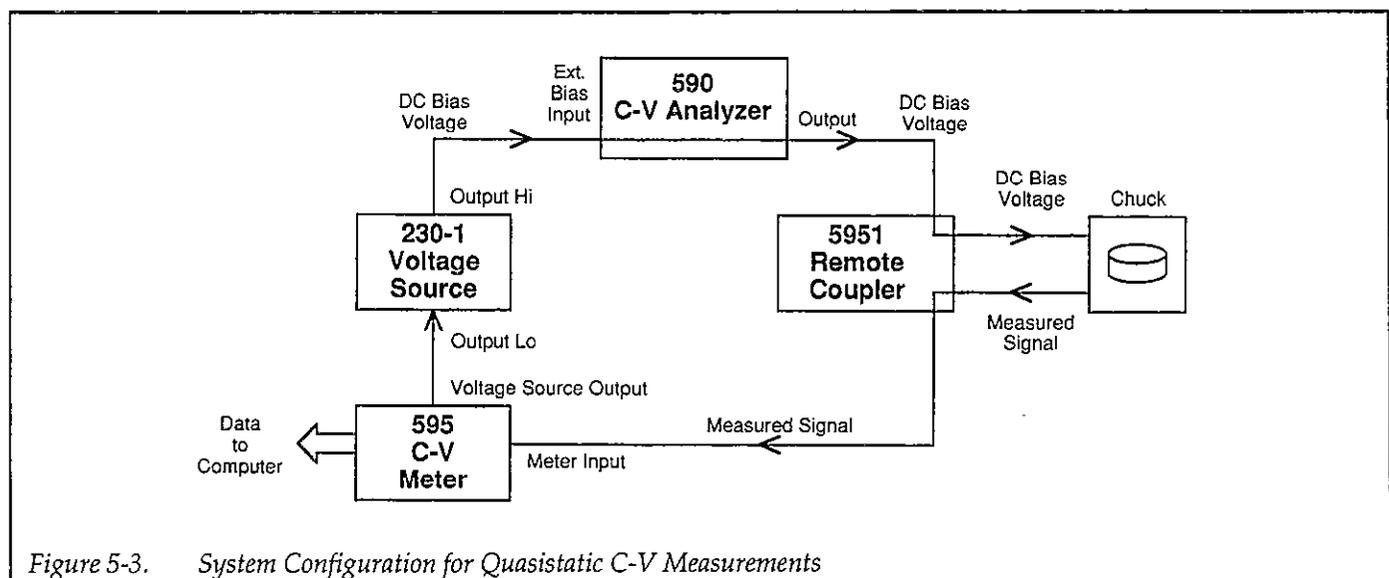
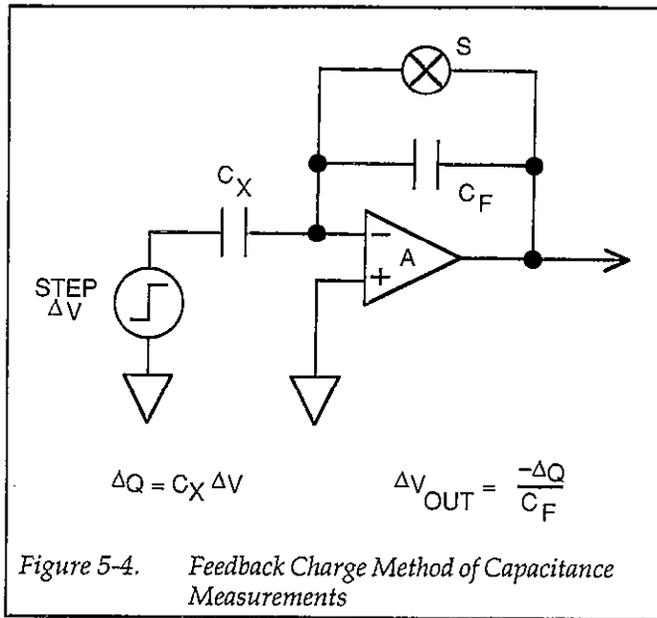

Figure 5-3. System Configuration for Quasistatic C-V Measurements



charge made immediately before the voltage step occurs. Q3 is measured after a specified delay time (t_{DELAY}) and is an indication of the final charge transferred through C_X . Q2 is measured before Q3 (preceding it by t_0) and is used to determine the slope of the charge waveform. This slope represents the amount of current (Q/t) flowing in C_X during the final portion of the delay time, t_0 . Q/t represents the leakage current in C_X or the system. The corrected capacitance (cCAP) feature of the instrument can be used to compensate for substantial leakage currents; cCAP calculations are shown in Figure 5-5.

Initially, the feedback capacitor, C_F , is discharged by closing switch, S, which is in parallel with C_F . When the measurement begins, the switch is opened, and any charge transferred from the capacitor to the integrator input will now cause a change in integrator output as follows:

$$\Delta V_{OUT} = -Q/C_F$$

The voltage source is then changed by a small amount, ΔV , which causes a charge to be transferred to C_X . The charge on C_X is proportional to the voltage change: $dQ = C_X dV$, and that charge is then applied to the integrator input, resulting in a charge at its output. The charge on the feedback capacitor is determined by measuring the integrator output both before and after the voltage step and making the following calculation:

$$\Delta Q = -C_F \Delta V_{OUT}$$

The unknown capacitance, C_X , is then calculated as follows:

$$C_X = \Delta Q / \Delta V = C_F \Delta V_{OUT} / \Delta V$$

Figure 5-5 shows how the charge waveform is actually measured. Q1, Q2, and Q3 represent charge measurements made at three specific times. Q1 is the baseline

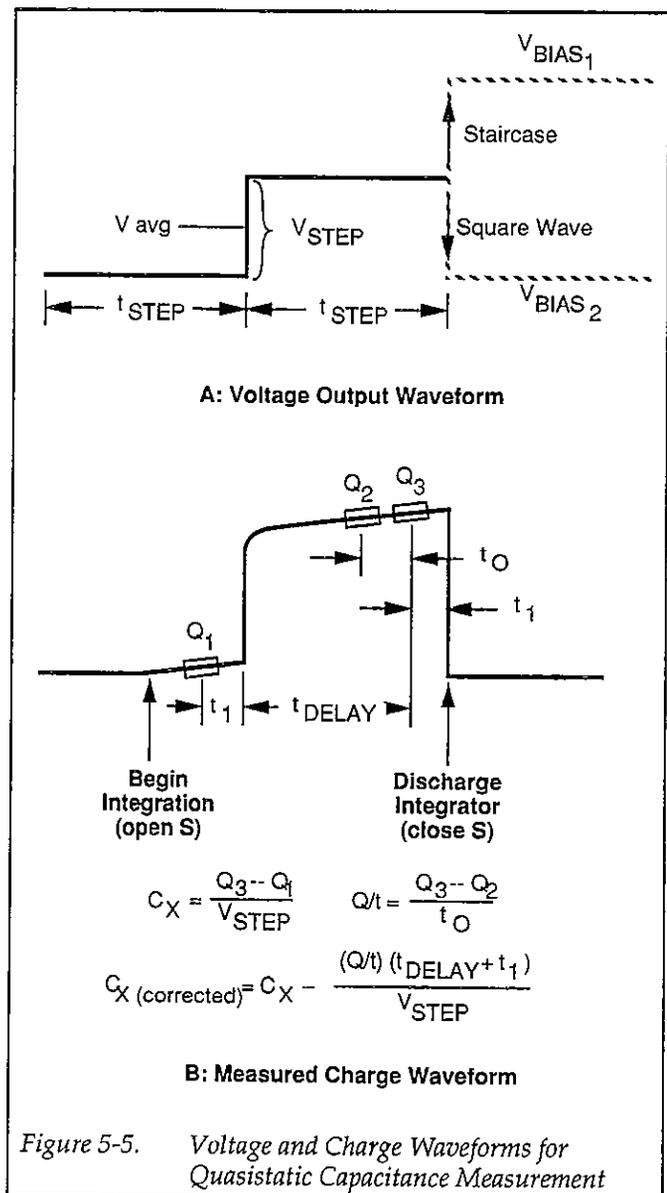

5.5 HIGH FREQUENCY C-V

5.5.1 High Frequency System Configuration

A block diagram showing system configuration during high-frequency measurements is shown in Figure 5-6. The system is somewhat similar to the configuration for low-frequency measurements discussed above. Now, however, the Model 590 supplies a 100kHz or 1MHz test signal to the device under test and measures resulting gain and phase variations to determine capacitance and conductance values, as described below.

Even though the Model 590 has its own internal DC voltage source, that source is not used for the Model 82-DOS system. Instead, a DC bias voltage, supplied by the Models 230-1 and 595, is routed through the Model 590, and is then applied as a composite AC and DC test signal to the device under test.

One additional aspect of the high-frequency system is the 100kHz/1MHz frequency control of the Model 5951 remote input coupler. This function is performed by the Model 230-1 through its digital I/O port.

5.5.2 High-Frequency Measurements

A simplified block diagram of the high-frequency C-V modules located in the Model 590 is shown in Figure 5-7. The 100kHz and 1MHz modules do differ somewhat in detail, but their operation can be represented as outlined here.

A 100kHz or 1MHz reference signal is first generated by the waveform synthesizer, and then amplified and shaped into a sine wave by the output amplifier. The output coupling section isolates the signal and attenuates it to approximately 15mV RMS at 100kHz or 1MHz, depending on the selected test frequency. The DC bias voltage, which is supplied by the Models 230-1 and 595, is also applied at this point.

The test signal is then routed through the OUTPUT jack to the device under test, and then fed back through the test INPUT jack of the Model 590. The signal undergoes a phase and magnitude transformation, both of which depend on the complex impedance of the device under test. The test signal then undergoes current-to-voltage transformation, is further amplified, and is finally applied to the synchronous detector, which extracts phase and magnitude information. The detector provides output voltages analogous to the capacitance and conductance of the device under test.

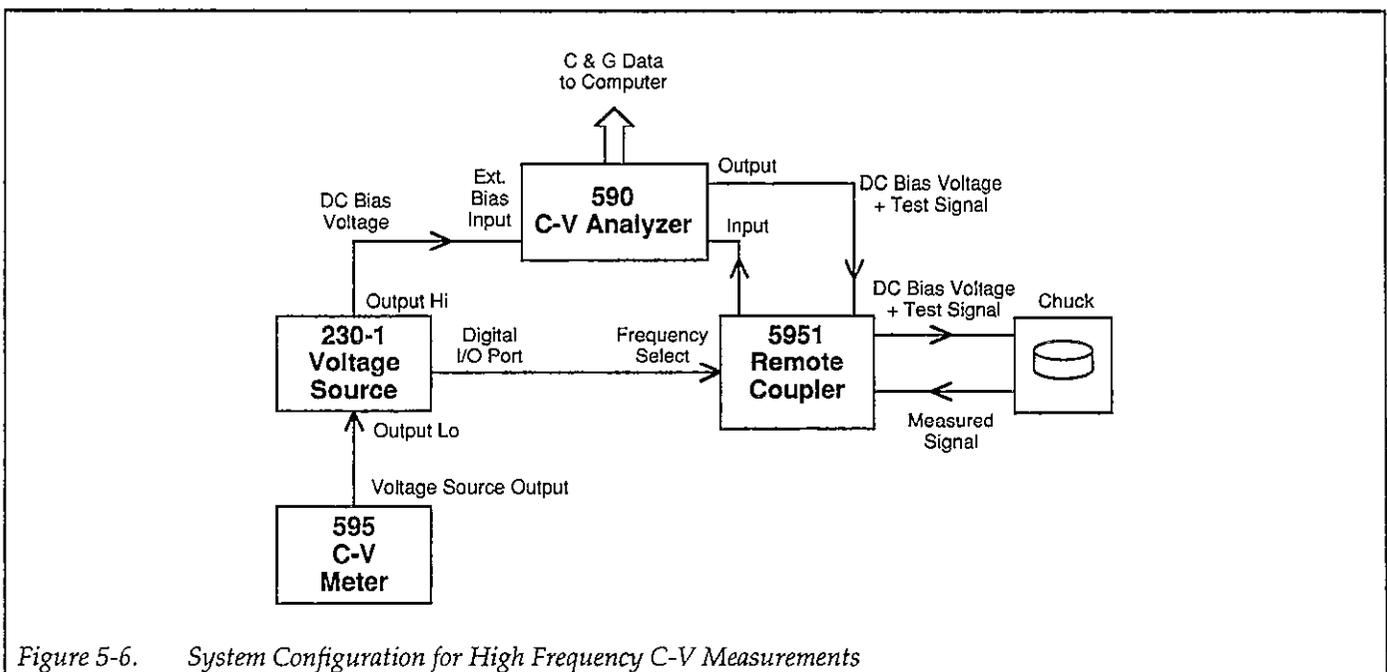

Figure 5-6. System Configuration for High Frequency C-V Measurements

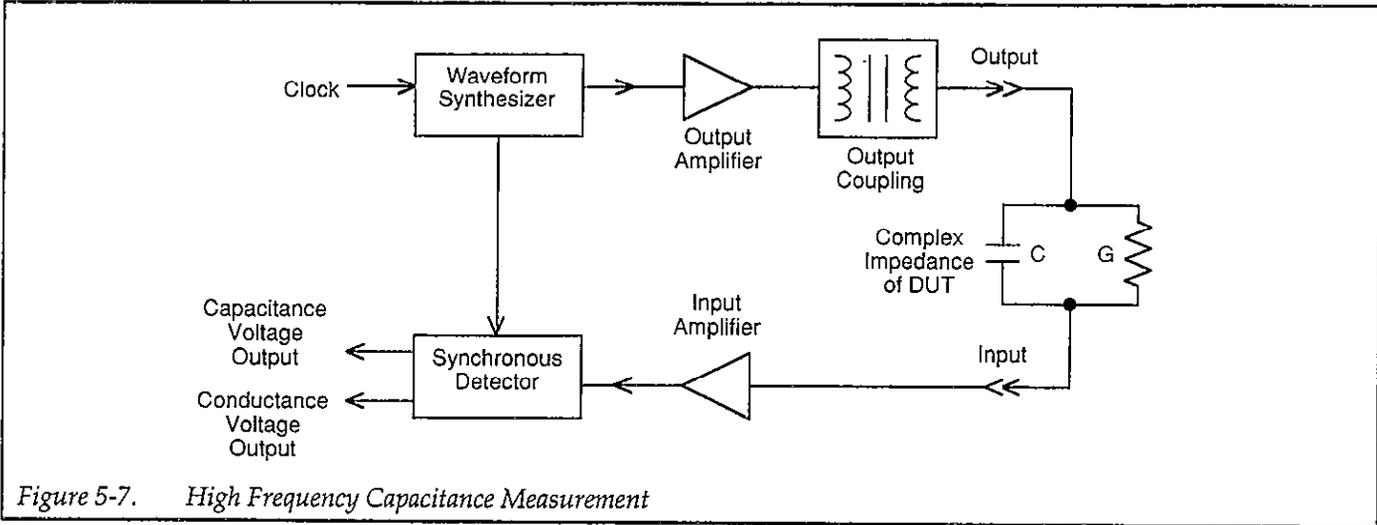

Figure 5-7. High Frequency Capacitance Measurement

5.6 SIMULTANEOUS C-V

In order to eliminate drift errors due to voltage stress, the Models 590 and 595 both measure capacitance during the same voltage sweep. The readings from the two instruments are synchronized using external triggering and are taken alternately during the sweep. After the sweep, C_Q is interpolated to the voltage at which C_H was measured.

Figure 5-8 shows a simplified representation of the stepped bias voltage supplied by the Model 595 during a measurement sweep. Each vertical voltage step size depends on the programmed Model 595 bias step, while each horizontal time step is determined by the programmed delay time.

As discussed above, a quasistatic measurement is a two-step process requiring at least two charge measurements. Initially, at the end of step S_1 , the first charge measurement Q_1 is made, after which the voltage goes to the next step. Following the programmed delay period, the Q_3 charge measurement is made, and the capacitance is then calculated from these values and the step size; note that the voltage at this capacitance is assumed to be midway

between the step increment values, or V_{AVG} in this case. Here we see that two voltage steps are necessary for every low-frequency capacitance measurement.

The Model 590 is triggered one delay time after the completion of each Model 595 reading. As a result, high-frequency measurements are made only on every other step (as represented by small rectangles in Figure 5-8). Furthermore, notice that the high-frequency measurements are not made at exactly the same voltage as the low-frequency measurements. In our present example, C_{H1} is measured at V_2 . While C_1 is averaged between V_1 and V_2 , and C_2 is between V_3 and V_4 .

To compensate for this voltage skew, an adjusted low-frequency capacitance value, C'_1 , is interpolated to a value at V_2 , where C_{H1} was taken, as follows:

$$C'_1 \text{ at } V_2 = C_1 + \frac{C_2 - C_1}{V_4 - V_2} \cdot \frac{V_{STEP}}{2}$$

All C_Q readings in the array are replaced by C'_Q values upon completion of the voltage sweep.

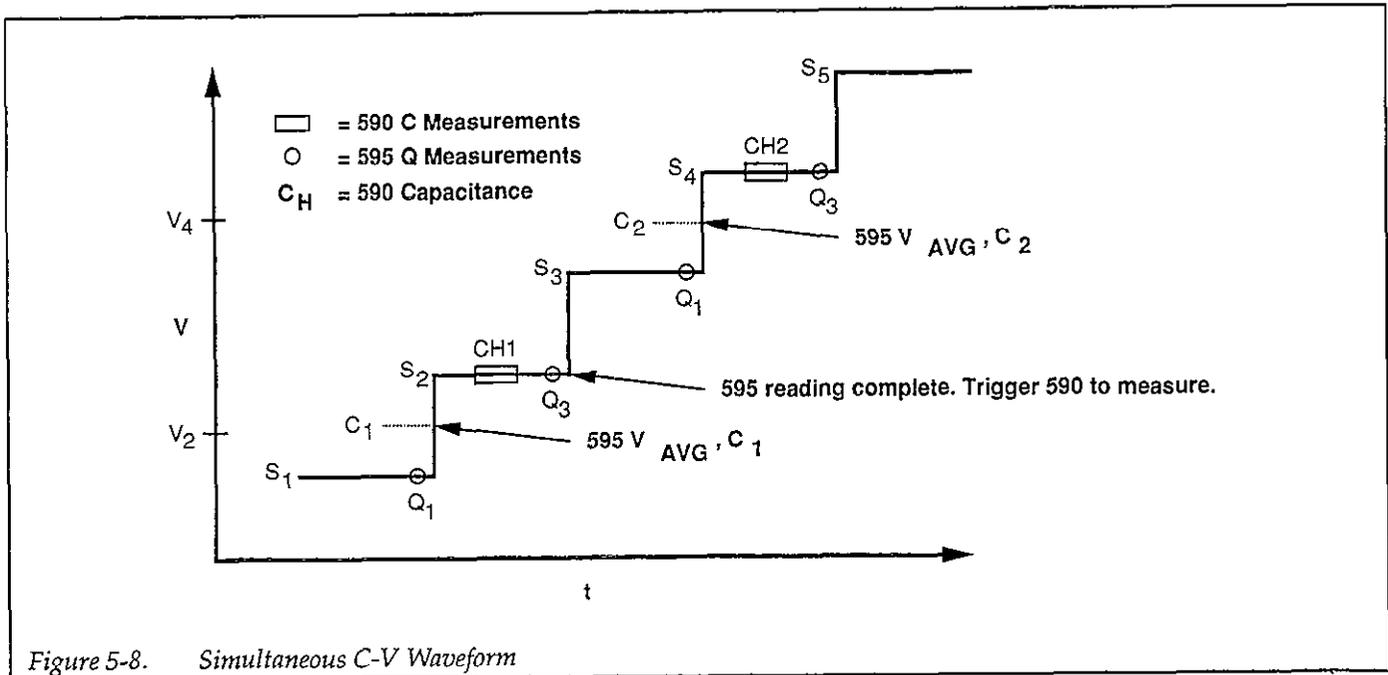

Figure 5-8. Simultaneous C-V Waveform

SECTION 6

Replaceable Parts

6.1 INTRODUCTION

This section contains a list of replaceable parts for the Model 5951 Remote Input Coupler, as well as additional parts for the Model 230-1 Programmable Voltage Source (parts common to the Models 230 and 230-1 are listed in the Model 230 Instruction Manual). Component layouts and schematic diagrams for these instruments are also included.

6.2 PARTS LIST

Electrical parts for the Model 5951 are listed in order of circuit designation in Table 6-1 and Table 6-2. Table 6-3 lists Model 5951 mechanical parts. Table 6-4 summarizes parts specific to the Model 230-1 only.

6.3 ORDERING INFORMATION

To place a parts order, or to obtain information concerning replacement parts, contact your Keithley representative or the factory (see the inside front cover for addresses). When ordering parts, be sure to include the following information:

1. Unit model number (230-1 or 5951)
2. Unit serial number
3. Part description
4. Circuit description, if applicable
5. Keithley part number

6.4 FACTORY SERVICE

If the unit is to be returned to Keithley Instruments for repair or service, perform the following:

1. Complete the service form at the back of this manual, and include it with the unit.
2. Carefully pack the card in the original packing carton.
3. Write ATTENTION REPAIR DEPARTMENT on the shipping label.

6.5 COMPONENT LAYOUTS AND SCHEMATIC DIAGRAMS

Component layout drawings and schematic diagrams for the Models 230-1 and 5951 are included on the following pages.

TABLE 6-1. HIGH FREQUENCY AND CONTROL BOARD, PARTS LIST

CIRCUIT DESIG.	DESCRIPTION	KEITHLEY PART NO.
	LABEL, WARNING	MC-233
	POLARIZING KEY	CS-491
	#22 TEFLON SLEEVING	
	2-56 NUT	2-56NUT
	2-56x7/16 PHIL PAN HD SCREW	2-56x7/16PPH
	4-40x3/16 PHIL PAN HD SCREW	4-40x3/16PPHSEM
C1	CAP,.1uF,20%,50V,CERAMIC	C-237-.1
C2	CAP,680pF,5%,500V,POLYSTYRENE	C-138-680P
C3,C4	CAP,7-70pF,500V,VARIABLE	C-345
C5	CAP,220pF,5%,500V,POLYSTYRENE	C-138-220P
C6,C7	CAP,2200pF,5%,500V,POLYSTYRENE	C-138-2200P
C8	SELECTED,100KHZ RESONANT CIRCUIT	5951-600
C9	CAP,150pF,5%,500V,POLYSTYRENE	C-138-150P
CR1	DIODE,SILICON,1N4148 (DO-35)	RF-28
DS1,DS2	PILOT LIGHT,RED,LED	PL-77
J3..J7	CONNECTOR,RIGHT ANGLE,BNC	CS-504
J8	CONN,FEMALE,16-PIN	CS-487-16
K1	RELAY,(SPDT)	RL-91
L4	CHOKE,3.3mH	CH-44
L5	CHOKE,60.1uH	CH-43
	LENGTH TO SUIT #22 AWG BUS WIRE	
Q1	TRANS,PNP SILICON,MPSU56 (CASE 152-02)	TG-148
R1	RES,560,5%,1/4W,COMPOSITION OR FILM	R-76-560
R2	RES,10K,5%,1/4W,COMPOSITION OR FILM	R-76-10K
R3	RES,1.2K,5%,1/4W,COMPOSITION OR FILM	R-76-1.2K
R4	RES,33,10%,1W,COMPOSITION	R-2-33
R5,R6	RES,100K,1%,1/8W,METAL FILM	R-88-100K
TE1,TE7	TERMINAL,INSULATED	TE-91
TE2..TE5,TE8	TERMINAL (TEFLON)	TE-97-1
U1	IC,LOW INPUT CURRENT OPTO,HCPL-2200	IC-411
U2	IC,HEX INVERTER,74HC04	IC-354

LTR. ECC NO.	REVISION	ENG. DATE
B 12144	RELEASED	5/15/57
B112451	REVISED	S.Z. 11-10-57
C 112839	REVISED	5-7-58

DATE	DESCRIPTION
001-1565	DN

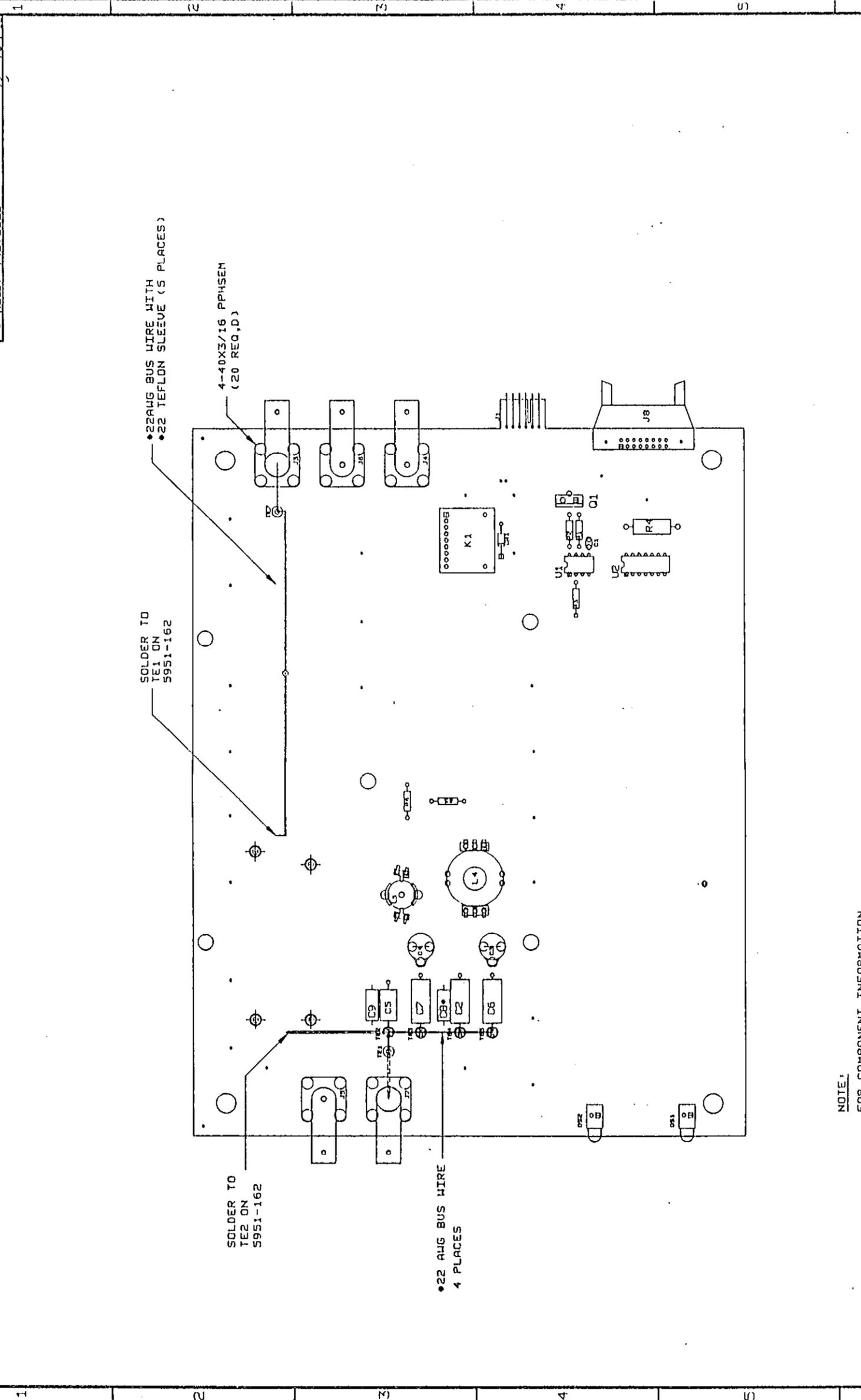

357	MODEL	NEXT ASSEMBLY	CTY
		USED ON	

DO NOT SCALE THIS DRAWING	DIMENSIONAL TOLERANCES UNLESS OTHERWISE SPECIFIED	DATE 5-20-58	SCALE 1:1	TITLE
XX=±.015	ANG.=±.2°	DRN. CB	5/26/58	COMPONENT LAYOUT, HIGH FREQUENCY & CONTROL BOARD
XXX=±.005	FRAC.=1/64	MATERIAL	SEE PAGE 1	
	SURFACE MAX. .03	FINISH	SEE PAGE 1	

NOTE:
FOR COMPONENT INFORMATION,
REFER TO BILL OF MATERIAL
(5951-000-01).

NO. 5951-100

TABLE 6-2. AC BLOCKING BOARD, PARTS LIST

CIRCUIT DESIG.	DESCRIPTION	KEITHLEY PART NO.
C1	CAP,1000pF,1%,100V,CERAMIC	C-372-1000P
C2	CAP,1800pF,1%,500V,MICA	C-209-1800P
L1	CHOKE,VARIABLE	CH-23
L2	CHOKE,15uH	CH-26-15
TE1,TE2	TERMINAL	TE-92

Ø91-1969 ON

LTR.	ECC NO.	REVISION	ENG.	DATE
A	1214	RELEASED	US	5/15/57

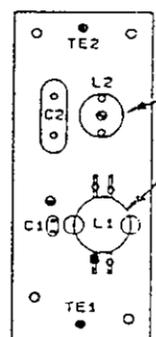

APPLY GLYPTOL TO ADJUSTMENT SCREWS AFTER FINAL CAL

NOTE:
FOR COMPONENT INFORMATION,
REFER TO BILL OF MATERIAL
(5951-000-03).

MODEL	NEXT ASSEMBLY	QTY.	USED ON

DO NOT SCALE THIS DRAWING	DIMENSIONAL TOLERANCES UNLESS OTHERWISE SPECIFIED	DATE 3-9-57	SCALE 1:1	TITLE	COMPONENT LAYOUT.
KEITHLEY KEITHLEY INSTRUMENTS INC. CLEVELAND, OHIO 44139	XX-2.015 ANG. ±2°	DRN. CB	ENG APPR. /		AC BLOCKING BOARD
	XXX-2.000 FRAC. ±.01/04	MATERIAL		C	NO. 5951-160
	SURFACE MAX. 0.005	FINISH			

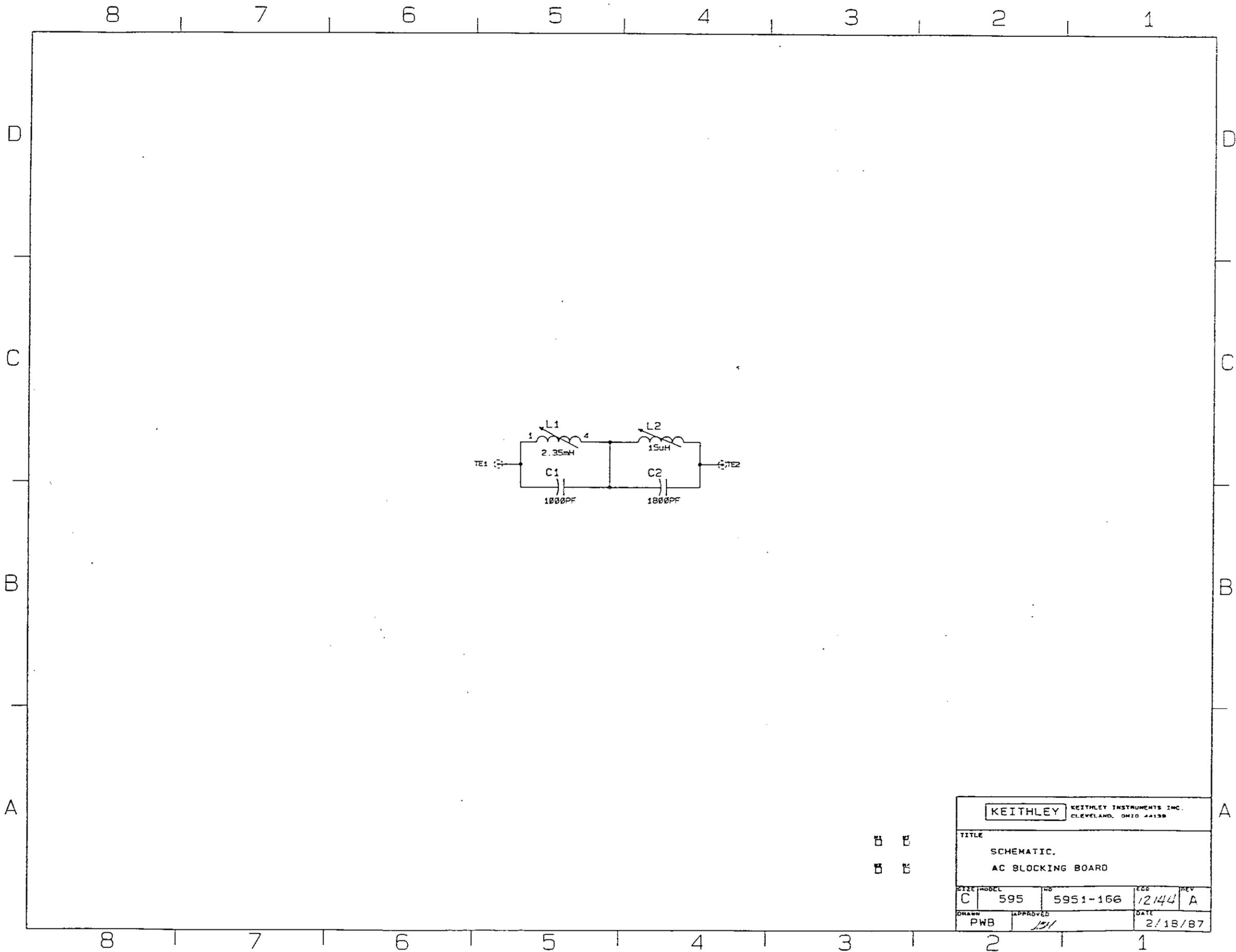

KEITHLEY		<small>KEITHLEY INSTRUMENTS INC. CLEVELAND, OHIO 44139</small>	
TITLE			
SCHEMATIC.			
AC BLOCKING BOARD			
SIZE	MODEL	NO	REV
C	595	5951-166	12/44 A
DATE	APPROVED	DATE	
2/18/87	<i>PWB</i>		

□ □
 □ □

TABLE 6-3. MODEL 5951 MECHANICAL, PARTS LIST

CIRCUIT DESIG.	DESCRIPTION	KEITHLEY PART NO.
	1/8"DIA.x1/4" SEMI-TUBULAR RIVET	1/8"x1/4" RIVET
	4-40 KEP NUT	4-40KEPNUT
	ARTWORK, REAR PANEL SILKSCREEN	5951-309
	ASSEMBLY	5951-300
	ASSEMBLY,CABLE	CA-91
	BOX	BOX 711
	BRACKET, SIDE	5951-311
	BRACKET,MTG	5951-307
	CABLE,BNC	MODEL 7051-2
	CASE, BOTTOM	5951-303
	CASE, TOP	5951-302
	CONNECTOR	CS-297-16
	CONNECTOR	CS-613-16
	FEET	FE-17-1
	GROMMET	GR-44-1
	GROMMET	GR-44-1
	IEEE CABLE,SHIELDED	MODEL 7007-2
	IEEE CABLES,SHIELDED	MODEL 7007-1
	LABEL, SERIAL NO	MC-285
	LOW NOISE BNC CABLES	MODEL 4801
	LUG	LU-7
	OVERLAY, FRONT PANEL	5951-305
	PANEL, FRONT	5951-304
	PANEL, REAR	5951-308
	PEM NUT	FA-40
	PEM STUD	FA-82
	PEM, STUD	FA-82
	PEMNUT	FA-18
	POLARIZING KEY	CS-474
	SHIELD, BOTTOM	5951-312
	SHIELD, TOP	5951-310
	ARTWORK, FRONT PANEL OVERLAY	5951-306
	BINDING POST	BP-25
	BOT SHIELD TO MB6-32x1/4 PHIL PAN HEAD SEM	6-32x1/4PPHSEM
	FOR CLOSING CASE6-32x1/4" PPHSEM BLACK ZINC FINISH	6-32x1/4PPHSEMBLKZIN
FOR FA-82	4-40 KEP NUT	4-40KEPNUT
FOR MTG BP-25	6-32x1/4 PHIL PAN HEAD SEM	6-32x1/4PPHSEM
FOR MTG FE-17-1	6-32x1/4" PHIL PAN HEAD	6-32x1/4PPH
	LENGTH 5 FEET CABLE,FLAT RIBBON	SC-63-4
	MB. TO CASE BOT 6-32x5/8 PHIL PAN HEAD SEM	6-32x5/8PPHSEM
	MTG F.P. TO M.B.BRACKET,MTG	5951-307
	SEE 5951-000-01 COMP L/O, M.B.	5951-100
	SHIELD TO CASE CAPACITOR C10	C-22-.01
	SHIELD TO SHIELD4-40x1/4 PHIL PAN HEAD SEM	4-40x1/4PPHSEM
	SOS-8632-20 STANDOFF	ST-186-1
	SWAGED IN SHIELDSTANDOFF	ST-139-4

TABLE 6-4. MODEL 230-1, PARTS LIST (specific to the 230-1 only)

CIRCUIT DESIG.	DESCRIPTION	KEITHLEY PART NO.
	ARTWORK, FILTER SUPPORT SILKSCREEN	230-313
	ARTWORK, FILTER SUPPORT SILKSCREEN	230-1-306
	ARTWORK, REAR PANEL LABEL	230-1-307
	BINDING POST	BP-11-2
	BINDING POST	BP-11-0
	BINDING POST	BP-15
	BINDING POST	BP-11-5
	CONNECTOR, BNC	CS-520
	CONNECTOR, MOLEX	CS-287-4
	HEAT SINK	HS-34
	INSULATOR, VINYL	27493-26
	JUMPER	J-3
	LABEL, REAR PANEL	MC-467
	NUT	3/8-32SMNUT
	PACKING LIST	PA-226
	PIN	CS-276
	SILKSCREEN, FILTER SUPPORT	230-312
	STAKING, FILTER SUPPORT	230-311
	STANDOFF	FA-45
	SUPPORT, FILTER	230-314
	SUPPORT, FILTER	230-1-305
	SWITCH	SW-271
	5/8" LG SHRINK TUBING	TX-17x5/8
	J1019,1020 CONNECTOR, PIN	CS-463
	LENGTH TO SUIT WIRE, BLACK	SC-68
	LENGTH TO SUIT WIRE, BLACK	SC-68
	LENGTH TO SUIT WIRE, RED	SC-68
	LENGTH TO SUIT WIRE, RED	SC-68
	P1019,1020 LUG	LU-90
	R404,405,408 RESISTOR	R-1-100
	R411 RESISTOR	R-2-33

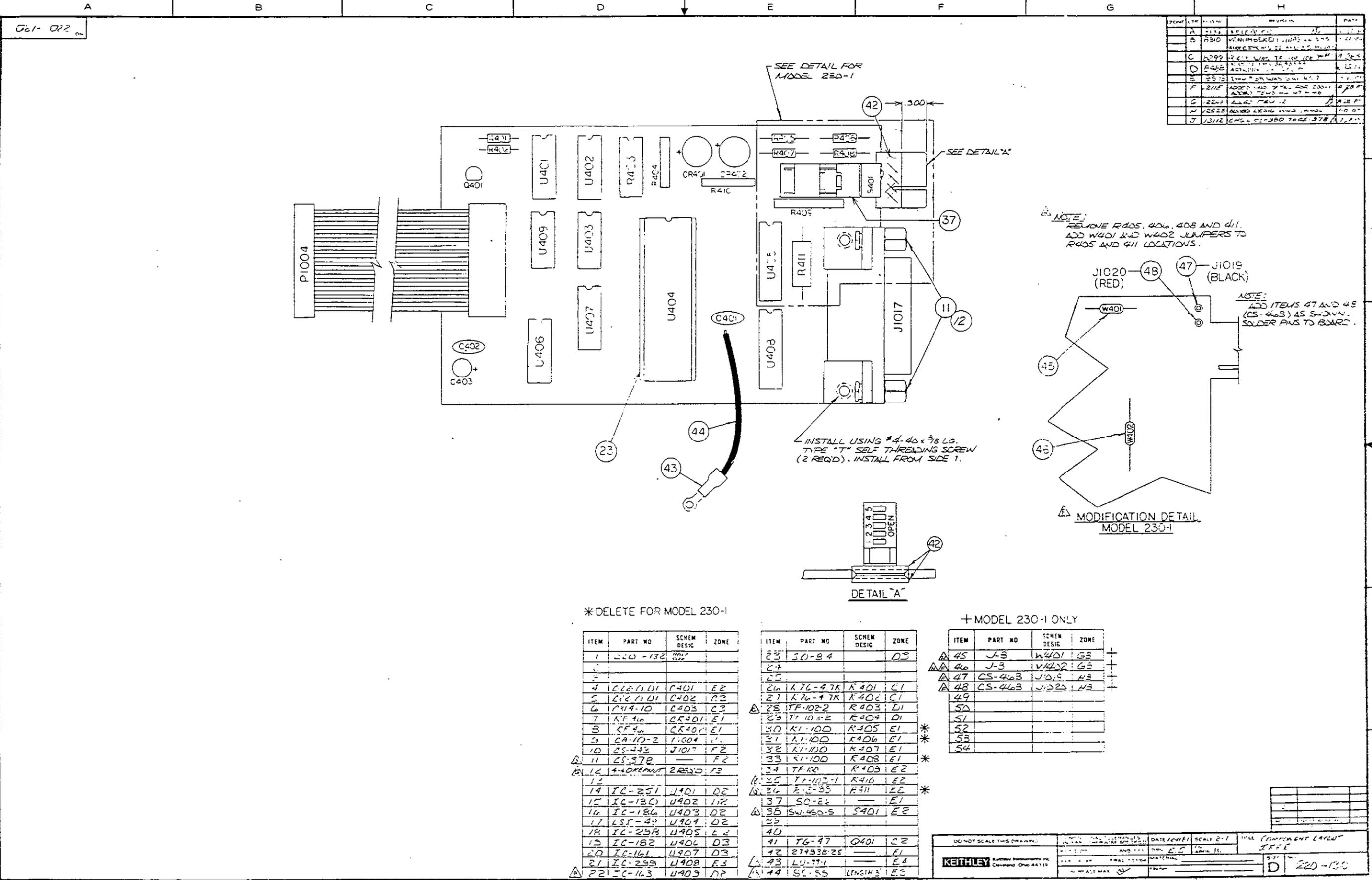

REV	DATE	DESCRIPTION	BY
A	11/14	REVISION	...
B	11/10	MINIMUMS	...
C	11/29
D	11/25
E	11/25
F	11/15
G	11/22
H	11/22
J	11/12

NOTE:
RELIEVE R405, 406, 408 AND 411.
ADD W401 AND W402 JUMPERS TO
R405 AND 411 LOCATIONS.

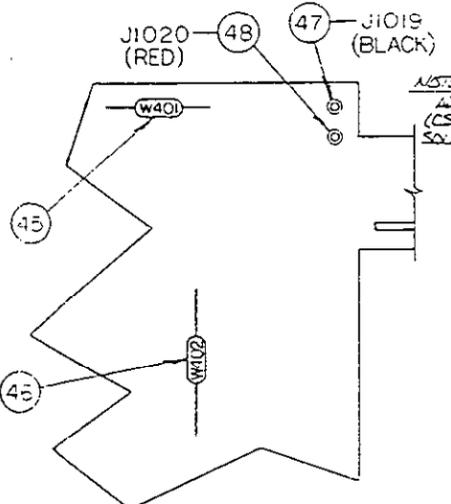

NOTE:
ADD ITEMS 47 AND 48
(CS-463) AS SHOWN.
SOLDER PINS TO BOARD.

MODIFICATION DETAIL
MODEL 230-1

INSTALL USING #4-40 x 3/8 LG.
TYPE "T" SELF THREADING SCREW
(2 REQ'D). INSTALL FROM SIDE 1.

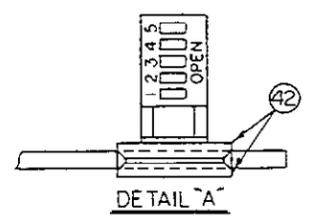

* DELETE FOR MODEL 230-1

ITEM	PART NO	SCHEM DESIG	ZONE
1	220-132	...	
4	IC-101	C401	E2
5	IC-101	C402	E3
6	IC-10	C403	E3
7	RF-10	R401	E1
8	RF-10	R402	E1
9	CA-10-2	J101	E1
10	CS-443	J1017	F2
11	CS-370	---	F2
12	4-40 SELF TAP	220-132	F2
14	IC-251	U401	D2
15	IC-130	U402	D2
16	IC-186	U403	D2
17	LST-43	U404	D2
18	IC-253	U405	E2
19	IC-182	U406	D3
20	IC-161	U407	D3
21	IC-255	U408	E3
22	C-163	U409	D2

ITEM	PART NO	SCHEM DESIG	ZONE
23	50-94	---	D3
26	K76-47R	R401	C1
27	K76-47R	R402	C1
28	TF-1022	R403	D1
29	TF-1052	R404	D1
30	K1-100	R405	E1
31	K1-100	R406	E1
32	K1-100	R407	E1
33	K1-100	R408	E1
34	TF-10	R409	E2
35	TF-102-1	R410	E2
36	E-3-35	R411	E2
37	SC-22	---	E1
38	SW-450-5	S401	E2
40	---	---	---
41	T6-47	Q401	C2
42	2793525	---	E1
43	LV-111	---	E1
44	SC-55	LENGTH 3	E3

+ MODEL 230-1 ONLY

ITEM	PART NO	SCHEM DESIG	ZONE
45	J-3	W401	G3
46	J-3	W402	G3
47	CS-463	J1019	H3
48	CS-463	J1020	H3
49	---	---	---
50	---	---	---
51	---	---	---
52	---	---	---
53	---	---	---
54	---	---	---

DO NOT SCALE THIS DRAWING

DATE: 11/14/54 SCALE: 2:1 TITLE: COMPONENT LAYOUT

DESIGNER: E.C. DRAWN BY: E.C.

MATERIAL: D 220-132

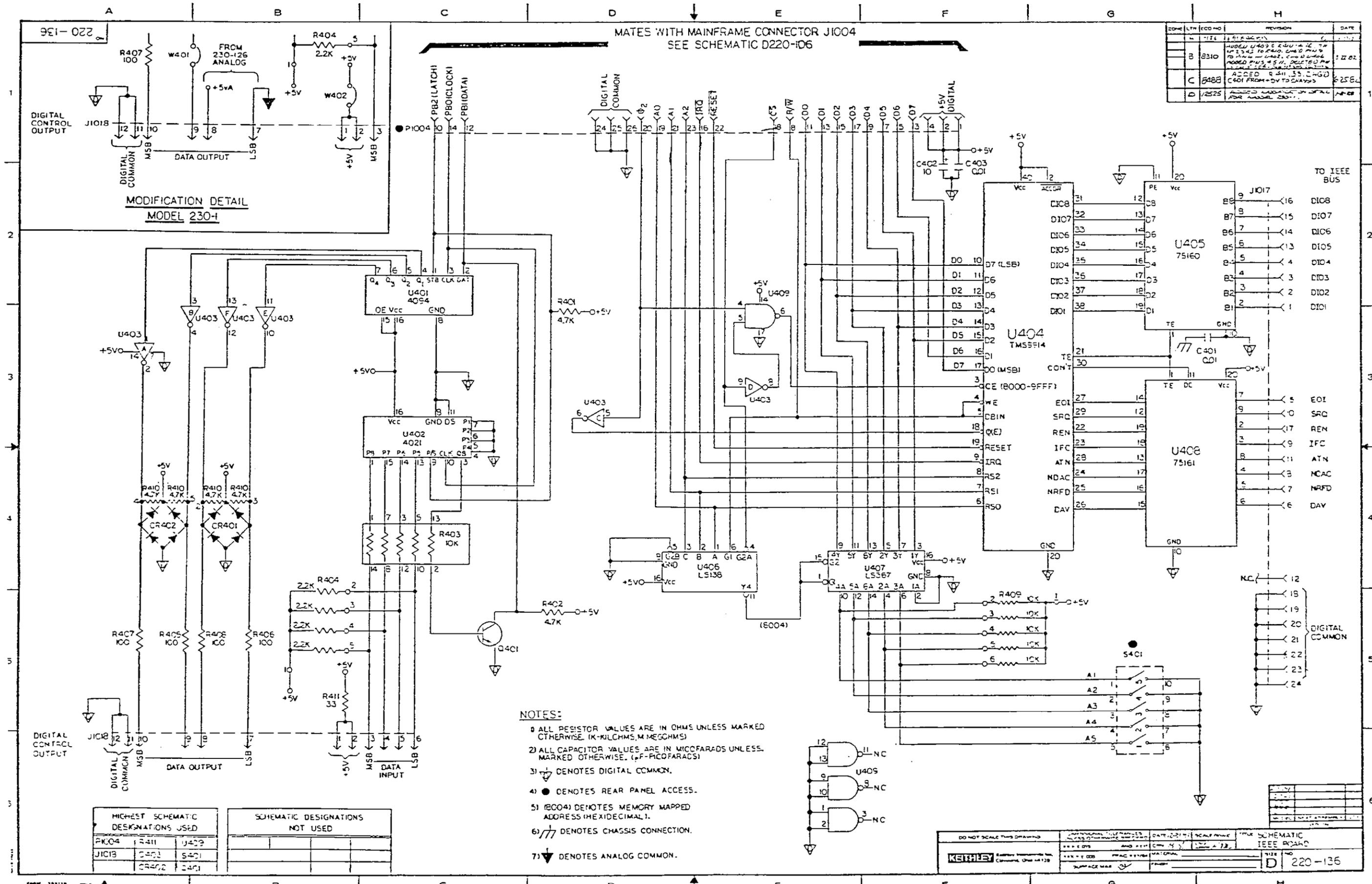

REV	DATE	DESCRIPTION
B	8/31/60	ADDED U405 TO BOARD TO PROVIDE TO LOGIC TO CLEAR ONE OF THE MODELS PLUS 4.5V. DELETED THE U401 FROM +5V TO CHASSIS.
C	8/28/60	ADDED R411, 33 OHM TO CLEAR C401 FROM +5V TO CHASSIS.
D	1/25/61	ADDED MODIFICATION OF BOARD FOR MODEL 230-1.

MODIFICATION DETAIL
MODEL 230-1

MATES WITH MAINFRAME CONNECTOR J1004
SEE SCHEMATIC D220-106

- NOTES:
- 1) ALL RESISTOR VALUES ARE IN OHMS UNLESS MARKED OTHERWISE. (K-KILOHMS, M-MEGOHMS)
 - 2) ALL CAPACITOR VALUES ARE IN MICROFARADS UNLESS MARKED OTHERWISE. (P-PICOFARADS)
 - 3) ∇ DENOTES DIGITAL COMMON.
 - 4) \bullet DENOTES REAR PANEL ACCESS.
 - 5) (E004) DENOTES MEMORY MAPPED ADDRESS (HEXIDECIMAL).
 - 6) --- DENOTES CHASSIS CONNECTION.
 - 7) ∇ DENOTES ANALOG COMMON.

HIGHEST SCHEMATIC DESIGNATIONS USED			SCHEMATIC DESIGNATIONS NOT USED		
J1004	R411	U403			
J1018	C401	S401			
	CR402	CR401			

DO NOT SCALE THIS DRAWING	DATE: 2-21-61	SCALE: 1:1	TITLE: SCHEMATIC
KETHLEY	DATE: 2-21-61	SCALE: 1:1	IEEE BOARD
			D 220-136

DATE	REVISION	BY	CHKD
1-27-54	1	W. J.
1-27-54	2	W. J.
1-27-54	3	W. J.
1-27-54	4	W. J.
1-27-54	5	W. J.
1-27-54	6	W. J.
1-27-54	7	W. J.
1-27-54	8	W. J.
1-27-54	9	W. J.
1-27-54	10	W. J.

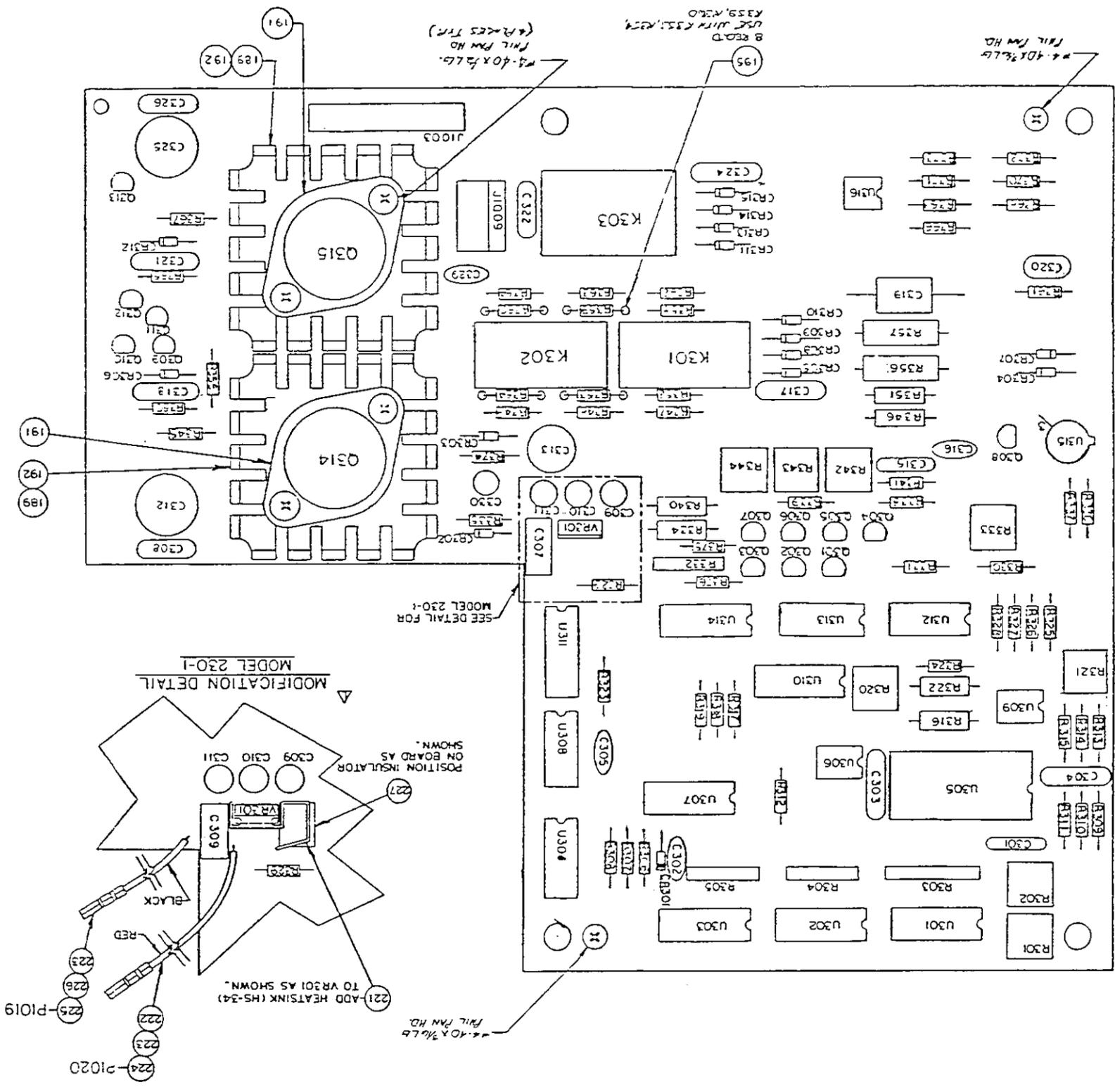

DATE	REVISION	BY	CHKD
1-27-54	1	W. J.
1-27-54	2	W. J.
1-27-54	3	W. J.
1-27-54	4	W. J.
1-27-54	5	W. J.
1-27-54	6	W. J.
1-27-54	7	W. J.
1-27-54	8	W. J.
1-27-54	9	W. J.
1-27-54	10	W. J.

APPENDIX A

Material Constants File Modification

As shipped, Model 82-DOS is intended to work with devices with a silicon substrate, a silicon dioxide insulator, and aluminum gate material. Constants that define these and other parameters are stored in a file called MATERIAL.CON, which is automatically loaded by the Model 82-DOS software at run time. (Figure A-1 shows the general format and factory default values stored in MATERIAL.CON, and Table A-1 summarizes default constant values.) Since this file is in ASCII format, you can modify these values by editing the file using a text editor or a word processor that can handle straight ASCII files.

Before making changes, you should create a backup version of the file under a similar filename (for example MATERIAL.DEF). Also, be careful not to alter the overall file format in any way.

NOTE

The Model 82-DOS software may not run properly if you change the format of MATERIAL.CON from that shown in Figure A-1. Also, changing constants to improper values will probably lead to erroneous results in analysis.

Procedure:

1. From DOS, select the directory in which MATERIAL.CON is located (default=C:\KTHLY_CV\MODEL82).
2. Make a backup copy of MATERIAL.CON by typing the following:

```
COPY MATERIAL.CON MATERIAL.DEF <Enter>
```
3. Load the MATERIAL.CON file into your text editor or word processor. A typical command might be:

```
ED MATERIAL.CON <Enter>
```
4. Using Figure A-1 as guide, make the desired value changes, but be sure that the != symbols appear before each value.
5. Save the file using the name MATERIAL.CON after all changes have been made. Remember that the file must be saved in straight ASCII format. (Most text editors automatically save in ASCII format, and many word processors have an ASCII format save option.) Also, remember to save this file in the default \KTHLY_CV\MODEL82 directory so the program can locate it at run time.
6. Run the Model 82-DOS software in the usual manner. The new constants will be used by the program for analysis.

Table A-1. Default Material Constants File (MATERIAL.CON)

Symbol	Description	Default Value
q	Electron charge (Coul.)	1.60219×10^{-19} Coul.
k	Boltzmann's constant (J/°K)	1.38066×10^{-23} J/°K
T	Test temperature (°K)	293°K
ϵ_{OX}	Permittivity of oxide (F/cm)	3.4×10^{-13} F/cm
ϵ_s	Semiconductor permittivity (F/cm)	1.04×10^{-12} F/cm
E_G	Semiconductor energy gap (eV)	1.12eV
n_i	Intrinsic carrier concentration (1/cm ³)	1.45×10^{10} cm ⁻³
W_{MS}	Metal work function (V)	4.1V
X	Electron affinity (V)	4.15V

FILE: MATERIAL.CON
 DESCRIPTION: This file is used to initialize the physical constants associated with a particular type of MIS device. This file contains physical constants for the following device type at room temperature:

Silicon - Silicon Dioxide - Aluminum

substrate material ___ | insulator | ___ gate material

VARIABLE	DESCRIPTION	VALUE
KQ	Charge of an electron(Coul)	!= 1.60219E-19
Kk	Boltzmann's constant(J/K)	!= 1.38066E-23
Kt	Test temperature(K)	!= 293
KEox	Permittivity of oxide(F/cm)	!= 3.40000E-13
KEs	Permittivity of semiconductor(F/cm)	!= 1.04000E-12
KEg	Energy gap of semiconductor(eV)	!= 1.12
KNi	Intrinsic carrier concentration(1/cm ³)	!= 1.45000E+10
KPhim	Metal work function(V)	!= 4.1
*KX	Semiconductor electron affinity(V)	!= 4.15
	(see note)	

In modern integrated-circuit processing, heavily doped polysilicon is often used as the gate material instead of aluminum. If this is the case, the work function constants are computed as follows(as per Sze's book "Physics of Semiconductor Devices").

p - type polysilicon gate

KPhim = Semiconductor electron affinity + Energy gap of semiconductor

n - type polysilicon gate

KPhim = Semiconductor electron affinity

Figure A-1. Default Material Constants (MATERIAL.CON)

Below you will find a table of electron affinities for various semiconductors. This table was taken from page 438 of Helmut F. Wolf's book entitled "Semiconductors".

<u>semiconductor</u>	<u>electron affinity(V)</u>
Si	4.05
Ge	4.13
GaAs	4.07
GaP	3.21
GaSb	4.06
InAs	4.90
InSb	4.59
CdS	3.90

Below you will find a table of metal work functions for various metals at 300K. This table was taken from page 424 of Wolf's book.

<u>metal</u>	<u>work function(V)</u>
Ag	4.3-5.1
Al	4.1-4.3
Au	4.7-5.0
Ba	2.4-2.6
Ce	1.9-2.0
Cr	4.5-4.6
Cu	4.3-4.7
Mg	3.2-3.7
Mo	4.3-4.5
Ni	4.5-4.7
Pt	5.2-5.3
Si	5.1-5.2
W	4.5-4.6

*****NOTE*****

Version A2 of the 5957 software used a silicon electron affinity of 4.15 Volts. This number was taken from page 397 of Sze's book. After closer inspection, a discrepancy was found in Sze's book. On Sze page 850 you will find a table of electron affinities. In this table, silicon's electron affinity is 4.05 Volts which is consistent with other sources; more specifically Wolf.

Default Material Constants (MATERIAL.CON) (Cont.)

BIBLIOGRAPHY FOR MATERIAL.CON

NOTE: Refer to paragraph 4.8 for added references.

1. Sze, S.M. Physics of Semiconductor Devices. 2nd Edition. New York: John Wiley & Sons, 1981.
2. Wolf, H.F. Semiconductors. New York: John Wiley & Sons, 1971.

APPENDIX B

Analysis Constants

Constant	Menu Term	Description	Units
C _{OX}	Cox	Oxide capacitance	pF
R _{SERIES}	Rseries	Series resistance	ohms
N _{BULK}	Nbulk	Bulk doping concentration	cm ⁻³
C _{FB}	Cfb	Flatband capacitance	pF
V _{THRESHOLD}	Vthresh	Threshold voltage	V
t _{OX}	tox	Oxide thickness	nm
C _{MIN}	Cmin	Minimum capacitance	pF
φ _B	PhiB	Bulk doping	cm ⁻³
V _{FB}	Vfb	Flatband voltage	V
N _{EFF}	Neff	Effective oxide charge concentration	1/cm ²
Area	Area	Gate area	cm ²
N _{AVG}	Navg	Average doping concentration	cm ⁻³
λ	Lb	Extrinsic Debye length	μm
W _{MS}	Work Fn	Work function	V
Q _{EFF}	Qeff	Effective oxide charge	coul/cm ²
	DevType	Device type	n or p
	Best depth	Best depth	μm

APPENDIX C

Summary of Analysis Equations

Analysis Function	Computation	Comments
Doping Profile	$w = A\epsilon_s \left(\frac{1}{C_H} - \frac{1}{C_{OX}} \right)$ $N = (-2 \times 10^{24}) \frac{(1 - C_Q/C_{OX}) / (1 - C_H / C_{OX})}{A^2 q \epsilon_s} \cdot \left[\frac{d}{dV_{GS}} \left(\frac{1}{C_H^2} \right) \right]^{-1}$ <p>where: $\frac{d}{dV_{GS}} \left(\frac{1}{C_H^2} \right) \equiv \frac{\frac{1}{C_H^2(i)} - \frac{1}{C_H^2(i+1)}}{V_{GS}(i+1) - V_{GS}(i)}$</p>	<p>Computed for each V_{GS} value.</p> <p>Computed for each V_{GS} value.</p>
Flatbands	$C_{FB} = \frac{C_{OX} A \epsilon_s / \lambda (1 \times 10^4)}{(1 \times 10^{-12}) C_{OX} + A \epsilon_s / \lambda (1 \times 10^4)}$ <p>where: $\lambda = (1 \times 10^4) \sqrt{\frac{\epsilon_s k T}{q^2 N_X}}$</p> <p>Where: $N_X = N$ at 90% W_{MAX}, N_A or N_D</p>	<p>N_A or N_D</p>

NOTE: All calculations are performed in source code function: GrafDataPart1 () located in module: P82SUBA1.BAS.

Analysis Function	Computation	Comments
Interface Trap Density	$(\psi_s - \psi_0) = \sum_{V_{GS1}}^{V_{GS} \text{ last}} \left(1 - \frac{C_0}{C_{OX}}\right) 2V_{STEP}$ $\psi_s - \phi_B \rightarrow E_T$ <p>where: $\phi_B = (kT/q) \ln(N_X/n_i)$</p> <p>where: $N_X = N$ at 90% W_{MAX}, N_A or N_B</p> $D_{IT} = \frac{(1 \times 10^{-12})}{Aq} C_{IT}$	ψ_s determined by finding $(\psi_s - \psi_0)$ at V_{FB} and subtracting from all $\psi_s - \psi_0$ values.
Oxide Thickness/ Gate Area	$t_{OX} = \frac{A \epsilon_{OX}}{(1 \times 10^{-19}) C_{OX}}$	Re-arrange for A
Series Resistance Compensation	$C_C = \frac{(G_M^2 + \omega^2 G_M^2) C_M}{a^2 + \omega^2 C_M^2}$ $G_C = \frac{(G_M^2 + \omega^2 G_M^2) a}{a^2 + \omega^2 C_M^2}$ $a = G_M - (G_M^2 + \omega^2 C_M^2) R_{SERIES}$	
Threshold Voltage	$V_{THRESHOLD} = \left[\pm \frac{A}{10^{12} C_{OX}} \sqrt{4\epsilon_s q [N_{BULK} \phi_B + 2 \phi_B]} \right] + V_{FB}$	
Work Function	$W_{MS} = W_M - \left[W_S + \frac{E_G}{2} - \phi_B \right]$	
Effective Oxide Charge and Effective Charge Concentration	$Q_{EFF} = \frac{C_{OX}(W_{MS} - V_{FB})}{A}$ $N_{EFF} = \frac{Q_{EFF}}{q}$	
Average Doping Concentration	$\frac{\ln(N_{AVG} / n_i)}{N_{AVG}} = \left[\frac{q^2 \epsilon_s t_{OX}^2}{4kT \epsilon_{OX}^2} \right] \left[\frac{C_{MAX} - C_{MIN}}{C_{MIN}} \right]^2$	

Analysis Function	Computation	Comments
Ziegler (MCC) Doping Profile	$N(w) = \frac{(-2 \times 10^{24}) [(1 - C_Q / C_{Ox}) / (1 - C_H / C_{Ox})]}{A^2 q \epsilon_s} \cdot \left[\frac{d}{dV_{GS}} \left(\frac{1}{C_H^2} \right) \right]^{-1} \cdot g_2 \left(\frac{w}{\lambda} \right)$ <p>where,</p> $g_1 \left(\frac{w}{\lambda} \right) = \frac{2kT\epsilon_s}{q^2} \cdot \frac{1}{(w)^2 (N(w))}$ $g_1 \left(\frac{w}{\lambda} \right) = -2 \frac{g \left(\frac{w}{\lambda} \right)}{1 - g \left(\frac{w}{\lambda} \right)} + \frac{1 - g \left(\frac{w}{\lambda} \right)}{\frac{w^2}{\lambda^2}}$ $g_2 \left(\frac{w}{\lambda} \right) = \frac{1}{1 - g \left(\frac{w}{\lambda} \right)} \left(2 \frac{w^2}{\lambda^2} \frac{g \left(\frac{w}{\lambda} \right)}{\left[1 - g \left(\frac{w}{\lambda} \right) \right]^2} \right)$ $\lambda = \left(\frac{2kT\epsilon_s}{q^2 N} \right)^{1/2}$ $\frac{w}{\lambda} = (g - \ln g - 1)^{1/2}$	

APPENDIX D

Prefixes of Unit Values

Exponent	Prefix	Symbol	Exponent	Prefix	Symbol
10^{18}	exa	E	10^{-1}	deci	d
10^{15}	peta	P	10^{-2}	centi	c
10^{12}	tera	T	10^{-3}	milli	m
10^9	giga	G	10^{-6}	micro	μ
10^6	mega	M	10^{-9}	nano	n
10^3	kilo	k	10^{-12}	pico	p
10^2	hecto	h	10^{-15}	femto	f
10	deka	da	10^{-18}	atto	a

APPENDIX E

Using the Model 590 and 595 Programs

INTRODUCTION

Two programs included on a Model 82-DOS distribution diskette allow you to run the Model 590 or Model 595 separately, if desired. Of course, the measurement and analysis capabilities of each individual program are somewhat lower than for the simultaneous C-V software. Table E-1 summarizes important differences among the three programs.

USING THE MODEL 590 PROGRAM

Follow the procedure below when using the Model 590 program. Refer to Sections 2 and 3 of this manual for details on using the software, which is very similar to the applicable sections of the Model 82-DOS software.

1. With the power off, connect the Model 590 to the IEEE-488 bus of the computer.
2. Turn on the instrument power and allow the unit to warm up for one hour rated accuracy. During the power-up cycle, verify that the primary address is set to 15. If not, program it for that value.
3. Using the Model 7051 50 Ω cables, connect the DUT test fixture directly to the Model 590 INPUT and OUTPUT jacks (do NOT use the Model 5951 Remote Input Coupler). Refer to the Model 590 Instruction Manual for connection information.
4. Boot up the computer in the usual manner, and run the program called "KI590CV.EXE".

5. Check out system leakages, and perform a probes up suppression, as discussed in paragraph 3.4.
6. Perform cable correction as discussed in paragraph 3.5.
7. Determine C_{ox} using the general procedure covered in paragraph 3.6.
8. Set up your measurement parameters and perform a high-frequency C-V sweep on the device. The general procedure is given in paragraph 3.7.
9. Select the analysis option on the main menu, and perform the required analysis operations; see Section 4 and Table E-1 for details.

USING THE MODEL 595 PROGRAM

Follow the procedure below to use the Model 595 program. Refer to Sections 2 and 3 of this manual for details on using the Model 595 software. Applicable sections of the Model 595 software are very similar to the corresponding sections of the Model 82-DOS software.

1. With the power off, connect the Model 595 to the IEEE-488 bus of the computer.
2. Turn on the instrument power and allow the unit to warm up for two hours for rated accuracy. Use the MENU button to verify that the primary address is set to 28. If not, program it for that value.
3. Using the Model 4801 low-noise cables, connect the DUT test fixture directly to the Model 595 METER INPUT and VOLTAGE OUTPUT jacks (do NOT use the Model 5951 Remote Input Coupler). Refer to the

- Model 595 Instruction Manual for connection information, if required.
4. Boot up the computer in the usual manner, and run the program called "KI595CV.EXE".
5. Check out system leakages, and perform a probes up suppression, as discussed in paragraph 3.4.
6. Determine optimum delay time, as discussed in paragraph 3.6.
7. Set up your measurement parameters, and perform a quasistatic C-V sweep on the device. The general procedure is given in paragraph 3.7.
8. Select the analysis option on the main menu and perform the required analysis operation. See Table E-1 and Section 4 for details.

Table E-1. Comparison of Simultaneous C-V and Individual Programs

Model 82-DOS Software ¹	Model 590 Software ²	Model 595 Software ³
C _Q vs. V _{GS}		C _Q vs. V _{GS}
C _H vs. V _{GS}	C _H vs. V _{GS}	
C _Q & C _H vs. V _{GS}		
Q/t vs. V _{GS}		Q/t vs. V _{GS}
G vs. V _{GS}	G vs. V _{GS}	
w vs. V _{GS}	w vs. V _{GS}	
N vs. w	N vs. w	
Ziegler (MCC) N vs. w	Ziegler (MCC) N vs. w	
1/C _H ² vs. V _{GS}	1/C _H ² vs. V _{GS}	
D _{IT} vs. E _T		
ψ _S vs. V _{GS}		
C _Q vs. ψ _S		
C _H vs. ψ _S		
R _{SERIES}	R _{SERIES}	
C _{OX}	C _{OX}	C _{OX}
tox	tox	tox
Area	Area	Area
C _{MIN}	C _{MIN}	
N _{BULK}	N _{BULK}	
N _{AVG}	N _{AVG}	
C _{FB}	C _{FB}	
V _{FB}	V _{FB}	
φ _{BULK}	φ _{BULK}	
λ (L _B)	λ (L _B)	
Q _{EFF}	Q _{EFF}	
N _{EFF}	N _{EFF}	
W _{MS}	W _{MS}	
Threshold Voltage	Threshold Voltage	
Device Type	Device Type	
Best Depth	Best Depth	

¹ KI82CV.EXE

² KI590CV.EXE

³ KI595CV.EXE

APPENDIX F

Graphic 4.0 Functions Used by Model 82-DOS

© 1985, 1986, 1987 by Scientific Endeavors Corporation

All rights reserved. No part of this manual may be reproduced in any form or by any means without permission in writing from Scientific Endeavors Corporation.

No responsibility or patent liability is assumed by Scientific Endeavors Corporation with respect to the use of the information in this manual. While every precaution has been taken in the preparation of this information, the Scientific Endeavor Corporation assumes no responsibility and disclaim all liability for damages resulting from the use of this information. The Scientific Endeavors Corporation disclaims all warranties, express or implied, including any warranty of merchantability or fitness for purpose of use, arising out of or related to this publication or to the information herein.

bgnplot(monitor, screentype, "filename")

Int monitor	1 if picture is to be plotted on the screen and stored in Tektronix format. 0 if the picture is to be stored and not plotted.
Int screentype	't' if only text is to be displayed on the screen. 'g' or 'G' if only graphics is to be displayed on the screen. 'G' selects the EGA 800x600 mode. 'b' if both text and graphics are to be displayed. Only Corona PCs support this mode. The single quotes around the characters are required.
char *filename	The name given to the output Tektronix-type file. It must be enclosed in double quotes, and be sure to specify the correct drive. If you want to suppress the TKF file, use the name "notek".

bgnplot() is the first call that you should make to GraphiC. It opens an output file to receive the Tektronix formatted data, initializes the defaults for many parameters, and puts the computer into graphic mode if called for. **bgnplot()** should only be called one time, at the beginning of the plotting session.

putsg

STRING	string of text to be displayed
INTEGER	X position for the display
INTEGER	Y position for the display

This routine is used to display a string of text on the current graph using the matrix font. The X and Y position arguments are in lines and columns rather than pixels.

fontsetup

This routine is used to initialize the special matrix font. This font is used for drawing the menus and other labels on the completed graph. It is also used when drawing the cursor display.

roundq

INTEGER	number of divisions for the axis
FLOAT	minimum value
FLOAT	value to increment by
FLOAT	maximum value
STRING	format returned by this function

This function accepts a specification of the max and min values for the axis, along with the value to increment by and the number of divisions to use, and returns a format string that can be passed to the grid routine to draw the axis.

hardcopy(type)

char type	The type of hardcopy desired. type = 'l', 'm', 'L', 'M' for printer dump type = 0 to return GraphiC to normal interactive mode type = 'n' to continue through the remaining pictures without hard copies and without user intervention
------------------	---

hardcopy() allows GraphiC to make unattended hard copies of each GraphiC plot. To keep your plots from crossing the page boundary, remember that one 'L' (or 'l') plot or two 'M' (or 'm') plots use an entire page. **hardcopy()** should be called before the **endplot()** associated with the desired picture. This routine will not work with plotters.

font(nfont, "font1", 'esc1', "font2", 'esc2', "font3", 'esc3', "font4", 'esc4')

int nfont	The number of fonts selected, where 1 nfont 4
char *font#	The name of the font(s) to be selected must be in double quotes. The presently available fonts are: simplex.fnt, simgrma.fnt, complex.fnt, compital.fnt, compgrma.fnt, engoth.fnt, triplex.fnt, triptal.fnt, duplex.fnt, russian.fnt, simscr.fnt, comscr.fnt, microg.fnt, microb.fnt. The filled font is called block1.fnt. Be sure to specify the disk drive and path of each font.

page(width, height)

float width	The width of the picture in inches (or cm) as measured on the high resolution printer dump.
float height	The height of the picture in inches (or cm) as measured on the high resolution printer dump.

page() sets the size of the picture on the output page. Here, "width" and "height" refer to the shape of the picture viewed upright. The maximum picture size is 9.00" x 6.855" (unrotated) or 6.855" x 9.00" (rotated) corresponding to the size of the output page itself. If a smaller size is called for, it will be centered within this area unless **pgshift()** is used to offset it.

pgshift(xshift, yshift)

float xshift	The x-distance in inches (or cm) on an output page of the lower left corner of the picture from the corresponding corner of the output page, viewed with the picture upright.
float yshift	The y-distance in inches (or cm) on an output page of the lower left corner of the picture from the corresponding corner of the output page, viewed with the picture upright

If **pgshift()** is not called, **GraphiC** will center the picture on the output page. **pgshift()** is used, for example, to put several pictures on a single output page. It must be called after **page()** and before **area2d()**. If **rotate(1)** has been called, the shifts are with respect to the upper left corner of the monitor screen. If not, they are with respect to the lower left corner. See **D2TEST.C** for an example of how to do multiple plots page.

physor(xphysor, yphysor)

- float xphysor** x distance of physical origin from lower left corner of drawing page in inches (or cm).
- float yphysor** y distance of physical origin from lower left corner of drawing page in inches (or cm).
- physor()** allows you to move the plot on the drawing page.

area2d(xinch, yinch)

- float xinch** The length of the x-axis in inches (or cm), viewed with the picture upright, as measured on the high resolution printer dump.
- float yinch** The length of the y-axis in inches (or cm), viewed with the picture upright, as measured on the high resolution printer dump.

area2d() defines the lengths of the x and y axes. The size and positioning of the plot are determined by this call.

tmargin(marginch)

- float marginch** Size of top margin of text plot in inches (or cm) from the edge of the high-resolution printer plot.

tmargin() *must be called every time you start a new page of text plot.* It determines the top position of any text on the page. It must be called *before* **ctline()** or **ltline()**. The first line of text will be placed below this by a distance $\text{height} \times \text{ratio}$. To get text as near to the top of the page as possible, you might want to call **linesp(1.1)** before your first line of text.

lmargin(marginch)

- float marginch** Size of left-hand margin of text plot in inches (or cm) from the edge of a full page printer plot.

Although there is a small margin around the plots produced by **GraphiC**, you may wish to increase it. This routine only works with **ctline()** and **ltline()**.

numht(inch)

float inch	The height of the characters used to label the plot. The height is given in inches (or cm) on a full page output.
-------------------	---

axnamht(inch)

float inch	The height of the characters used to label the axes. The height is given in inches (or cm) on a full page output.
-------------------	---

rtline("string", height)

char *string	The line of text you wish plotted. You must determine whether it fits within your page size. The string must be enclosed in double quotes, and the first letter should be a font selection character.
float height	The height of your characters in inches (or cm) on the full page printer plot.

rtline() puts a line of text on the page flush against the right margin. The first line is at the location determined by **tmargin()**, and each succeeding line is placed below the previous one by a distance $\text{height} \times \text{ratio}$, where **ratio** is the argument of **linesp()**. The default ratio is 1.6.

ltline("string", height)

char *string	The line of text you wish plotted. You must determine whether it fits within your page size. The string must be enclosed in double quotes, and the first letter should be a font selection character.
float height	The height of your characters in inches (or cm) on the full page printer plot.

ltline() puts a line of text on the page flush against the left margin. The first line is at the location determined by **tmargin()**, and each succeeding line is placed below the previous one by a distance $\text{height} \times \text{ratio}$, where **ratio** is the argument of **linesp()**. The default ratio is 1.6. Indentation may be obtained by inserting tabs (`\ t`) into the text, or by a call to **lmargin()**.

ctline("string", height)

char *string	The line of text you wish plotted. You must determine whether it fits within your page size. The string must be enclosed in double quotes. The first character in the string should be a font selection character.
float height	The height of your characters in inches (or cm) on the full page printer plot.

`ctline()` centers a line of text on the page between the left margin and the right margin. The first line is at the location determined by `tmargin()`, and each succeeding line is placed below the previous one by a distance `height*ratio`, where `ratio` is the argument of `linesp()`. The default ratio is 1.6.

prtfnt(x, y, "string", height, angle)

float x	x location of lower left corner of the string from the left hand edge of the drawing page -- measured in inches (or cm) on the full page printer plot.
float y	y location of lower left corner of the string from the bottom of the drawing page -- measured in inches (or cm) on the full page printer output.
char *string	String to be plotted.
float height	Height of the characters in inches (or cm) on the full page output.
int angle	Angle at which the string is to be plotted. The angle is defined to increase in the counterclockwise direction, and is measured in degrees from the positive x axis. Any integer degree from -180 to +180 is allowed.

`prtfnt()` can be used for making text slides and view-graphs since it doesn't require any plotting commands other than those in levels 0 and 1. Ordinarily, the paper is oriented with the long direction horizontal. The orientation may be changed by calling `rotate()`. Using `lmargin()`, `tmargin()`, `linesp()`, `ctline()`, and `ltline()` makes the production of text slides easy. You must still call `page()`. All the size and location parameters are absolute unless `setscale(1)` is called.

grid(isgrid)

Int **isgrid** = 0 if no grid is desired.
 = 1 if dotted grid is desired.
 = 2 if fine dot grid lines are desired.
 = 3 if solid grid lines are desired.

grid() draws dotted lines through the tick marks. It must be called before the axis-creating routines.

fgrid(isgrid, nxdiv, nydiv)

Int **isgrid** = 0 if no grid subdivisions are desired.
 = 1 if dotted grid lines on subdivision marks are desired.
 = 2 if only tick marks at subdivisions are desired.

Int **nxdiv** The number of desired subdivisions between main grid lines on the x axis.

Int **nydiv** The number of desired subdivisions between main grid lines on the y axis.

fgrid() allows you to draw one or more grid lines between adjacent axis tick marks. This feature prevents overlapping of axis labels. To use **fgrid()**, you must

also call **grid()**. With logarithmic axes, the requested number of divisions is ignored, and 10 grid lines per decade are plotted. **fgrid()** also allows you to put small tick marks at subdivision spaces without drawing grid lines.

upright(uplab)

Int **uplab** = 1 to turn on upright y-axis labels.
 = 0 to turn off upright y-axis labels.

When **upright()** is called with a 1, it sets a flag that causes the y axis labels to be upright. This mode will stay in effect until **upright()** is called with a 0.

scales(nxdiv, nydiv, x, y, npts)

Int nxdiv	The number of x axis divisions.
Int nydiv	The number of y axis divisions.
float *x	The vector of x data. Be sure to dimension it in your calling routine.
float *y	The vector of y data.
Int npts	The number of data points in the x and y vectors.

scales() is the self-scaling routine for linear plots. It calculates the maximum and minimum values of x and y, and chooses the appropriate set of round numbers to use as axis labels and then calls graf(). The data must be calculated before scales() is called.

graf("xformat", xori, xste, xmax, "yformat", yori, yste, ymax)

char *xformat	The x-axis format. Use a floating point conversion specification (see p146 in K&R). Since it is a character string, it must be enclosed in double quotes. For example: "%-3.2f". Use "%-1.0f" for integer labels. Because C automatically expands the format to accommodate the required number of characters, it is best to use a width (number to the left of the decimal point) that is too small. This ensures that the labels will be centered. %e and %g formats may also be used.
float xori	The value of x at the left-hand end of the x axis.
float xste	The change in x between each two tick marks on the x axis.
float xmax	The value of x at the right-hand end of the x axis.
char *yformat	The y axis format (see above).
float yori	The value of y at the bottom of the y axis.
float yste	The change in y between each two tick marks on the y axis.
float ymax	The value of y at the top of the y axis.

graf() is the primary axis setup routine for x-y plots. Because the maximum and minimum values of the variables are supplied by you, graf() may be called either before or after the data are calculated. Any values of x and y which lie beyond the page boundaries will be scissored.

heading("title")

char *title The title for the plot. It must be less than 30 characters long. It is centered at the top of the picture. The first character may be a font selection character, otherwise, the currently active font is used.

heading() must be called if you want to caption a 2-D plot.

xname("xlabel")

char *xlabel The name of the x axis. It must be less than 30 characters long. The double quotes are required. The first character may be a font selection character. Super- and subscripts may be used.

xname() must be called if you want the x axis of a 2-D plot to have a name.

yname("ylabel")

char *ylabel The name of the y axis. It must be less than 30 characters long. The double quotes are required. The first character may be a font selection character. Super- and subscripts may be used.

yname() must be called if you want the y axis of a 2-D plot to have a name.

Color

The color default for supported color boards is white lines on a blue background. Curve colors may be changed by calls to **color()** as described below.

rightax(yright)

Int yright = 1 turns on right hand y-axis.
 = 0 turns off right hand y-axis.

rightax() is a parameter setting routine which will cause GraphiC to draw a right-hand y-axis. When this flag is set, the first time **scales()** is called the left-hand y-axis and the x-axis will be drawn. With a second call to **scales()** the program will rescale and draw the y-axis on the right side of the x-axis. This is done without recalculating or redrawing the x-axis.

axesoff(noaxes)

int noaxes = 0 (default) if labeled axes are desired.
 = 1 if no axes or axis labels are desired.

axesoff() allows you to draw plots with no axes or axis labels. Either **scales()** or **graf()** must still be called so that GraphiC can calculate the limits for the plot. **axesoff()** cannot be used with contour plots. It must be called before any routines which draw the axes, i.e., **graf()** or **scales()**. **axesoff()** can also be used with 3-D routines. Note that **axesoff()** only turns off the axes. Grid lines (and fine grid lines) will still be drawn if the options are active.

startplot(color)

int color The IBM color number to be used for the background of the plot. See **color()** for a list of available colors.

startplot() initializes each plot by putting necessary information into the file containing the plot data. It also raises the program to Level 1

setcolor

INTEGER

This routine sets the current color that GraphiC will draw on the screen. It uses the IBM numbering system.

0 - Black	7 - White
1 - Blue	8 - Dark Grey
2 - Green	9 - Light Blue
3 - Cyan	10 - Light Green
4 - Red	11 - Light Cyan
5 - Magents	12 - Light Red
6 - Brown	

endplot()

endplot() is called after each page of plots is completed. It stores all of the remaining data for the plot and returns GraphiC to Level 1. **endplot()** resets the page rotation to its upright position. After the last page is completed, **stopplot()** must also be called.

stopplot()

stopplot() is called at the very end of the plotting session. It empties the buffers and closes the plot and error files. It returns the screen to text mode, and GraphiC to Level 0.

curson()

A call to **curson()** turns on all of the cross hairs functions. Type an *Esc* to exit this mode. The axis drawing routines must be called before **curson()**.

When the program gets to the call to **curson()** the cross hairs will appear in the center of the plot area. To the left of the screen will be displayed a readout of the cross hairs position.

Movement of the cross hairs is controlled by the arrow keys or a supported mouse.

The readout will be in plot units by default. To change to inch units, type an *Alt-I*. An *Alt-U* will return the readout to plot units.

To draw lines, mark a point by typing *Enter*; move the cross hairs to the next point and type *Ins*. This line can be continued by moving the cross hairs to the next point and typing *Ins* again. Typing *Enter* will start a new line.

To erase a line, simply draw over it. You must start and end the erasure on the exact vector ends or it will not completely erase the line.

Every time *Enter* is typed, the x and y values of the cross hairs are entered in the global arrays `xgq[indq]` and `ygq[indq]` which are in user units and `cxq[cntq]` and `cyq[cntq]` which are in pixel units.

The cross hairs have three speeds which can be changed by typing *Alt-Y* successively.

When using a three-button Mouse, the left button is the same as *Enter*, the center button is the same as *Ins*, and the right button is the same as *Esc*. With a two-button mouse, the left button is the same as *Enter*, the right button is the same as *Ins*, and both buttons together are the same as *Esc*.

solid()

After **solid()** is called, all lines will be returned to their original unbroken manner until some other line style is activated

chndsh()

After `chndsh()` is called, all lines will be drawn as alternating dots and dashes until some other line style is called for.

curve(x, y, npts, sym)

float *x	The x vector to be plotted.
float *y	The y vector to be plotted.
int npts	The dimension of x and y.
int sym	sym = 0 draw curve only. sym > 0 draw curve and symbols every sym points. sym < 0 draw symbols only every sym points.

Each time `curve()` is called, a curve is drawn on the plot. Eight different symbols, for use as curve markers, and six different line styles are available. The line and symbol styles can be changed automatically by using the legend feature or manually by calling the appropriate routine (see pages 40, 49, and 50). `curve()` is used for any of the linear or logarithmic plots.

Scatter plots may be drawn by calling `scatplot()` with a 1 before calling `curve()`. You can still draw symbols every `sym` points.

scalexq

INTEGER

This routine is used to scale a value from GraphiC pixels to actual screen pixels. GraphiC uses a pixel array of 4096 by 3120 and scales this to the actual screen resolution.

scaleyq

INTEGER

This routine is used to scale a value from GraphiC pixels to actual screen pixels. GraphiC uses a pixel array of 4096 by 3120 and scales this to the actual screen resolution.

intopixq

FLOAT

This routine converts from inches on the GraphiC page into pixels on the GraphiC bitmap (4096 by 3120).

pixtoinq

FLOAT

This routine converts from pixels on the GraphiC bitmap to inches on the GraphiC page (9 by 11 inches).

lclr

INTEGER	line number to clear
INTEGER	starting column to clear
INTEGER	ending column to clear

This routine is used to clear a line in preparation for writing some text on the line with the matrix font.

passstr

STRING	standard BASIC string
---------------	-----------------------

Converts a BASIC string to C format and copies it into a special buffer. Each of the functions listed above has its own internal buffer. The function returns a 32 bit pointer to its internal buffer which can then be passed to any of the GraphiC functions requiring a string as an argument (such as Font).

passstr1

STRING standard BASIC string

Converts a BASIC string to C format and copies it into a special buffer. Each of the functions listed above has its own internal buffer. The function returns a 32 bit pointer to its internal buffer which can then be passed to any of the GraphiC functions requiring a string as an argument (such as Font).

passstr2

STRING standard BASIC string

Converts a BASIC string to C format and copies it into a special buffer. Each of the functions listed above has its own internal buffer. The function returns a 32 bit pointer to its internal buffer which can then be passed to any of the GraphiC functions requiring a string as an argument (such as Font).

passstr3

STRING standard BASIC string

Converts a BASIC string to C format and copies it into a special buffer. Each of the functions listed above has its own internal buffer. The function returns a 32 bit pointer to its internal buffer which can then be passed to any of the GraphiC functions requiring a string as an argument (such as Font).

passarr

Pointer Hex number identifying offset within the 64 k segment.
Segment Hex number identifying which 64k segment the array resides.

Converts the pointer to an array from BASIC format, consisting of a 16-bit segment and a 16-bit offset; to C format, consisting of one 32-bit pointer.

getstr

STRING standard BASIC string

Copies the contents of the internal buffer used by passstr (not passstr1, 2, or 3) into the BASIC string variable identified as the argument.

getxy

X pointer 32-bit pointer (C format) to array of X values
Y pointer 32-bit pointer (C format) to array of y values

Returns the X and Y values of markers selected using the graphics cursor.

APPENDIX G

Cable Calibration Utility

DESCRIPTION

The CABLECAL.EXE utility performs cable calibration for the Model 590 and Model 82-DOS. Note that this utility program can perform complete Model 82-DOS cable calibration or separate Model 590 cable calibration, which is intended primarily for use with the Model 5958 C-V Utilities.

STARTING CABLECAL.EXE

To start the cable calibration program, simply type in the following while in the \KTHLY_CV\MODEL82 directory:

```
CABLECAL
```

The main menu and startup banner shown in Figure G-1 will appear on the screen.

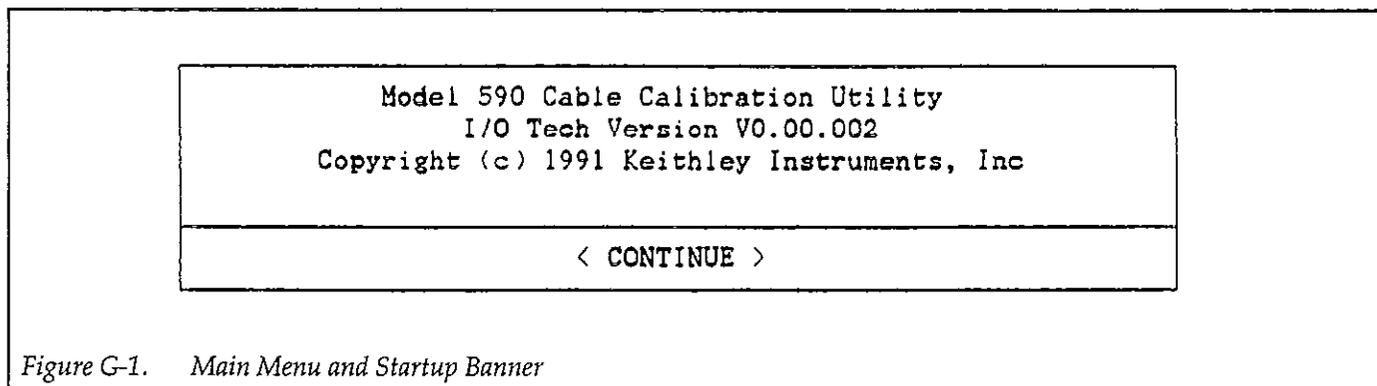

Figure G-1. Main Menu and Startup Banner

MAIN MENU SELECTIONS

A menu of selections will appear at the top of the screen. To select a main menu item, hold down the <Alt> key, and press the first letter of that selection, or use the left/right arrow keys to highlight the selection, then press <Enter>.

Use the <Tab> key to move the cursor around the screen. To enter numeric values, simply type in the desired value. Selecting OK will accept changes, and selecting Cancel will of course cancel those changes. You can also use the <Esc> key to close windows.

If your system has a compatible mouse, you can use the mouse to select various menu items. Simply move the cursor into position with the mouse, then click the appropriate mouse button.

FILE

Save

This selection saves the cable calibration constants to the existing filename. If a Model 82-DOS calibration was per-

formed, the file will be saved in a format compatible with the Model 82-DOS software. If a Model 590 range calibration was performed, the file will be saved in a Model 5958 format (see later topic in this appendix for format description). Note that you cannot perform a Model 590 range calibration and then save it using the PKG82CAL.CAL filename as that name is reserved for Model 82-DOS cable calibration.

Save As

This selection saves the cable calibration constants as above except that it saves to a user-defined filename.

Load

Selecting the Load option displays the Load window shown in Figure G-2. You can scroll through displayed filenames by using the scroll bar, up/down arrow keys, or by clicking on the box area. You can also type in the complete filename including a new path, if desired (the path will become the default for subsequent load/save operations). You can also specify the * character for the filename, and the default directory will be changed.

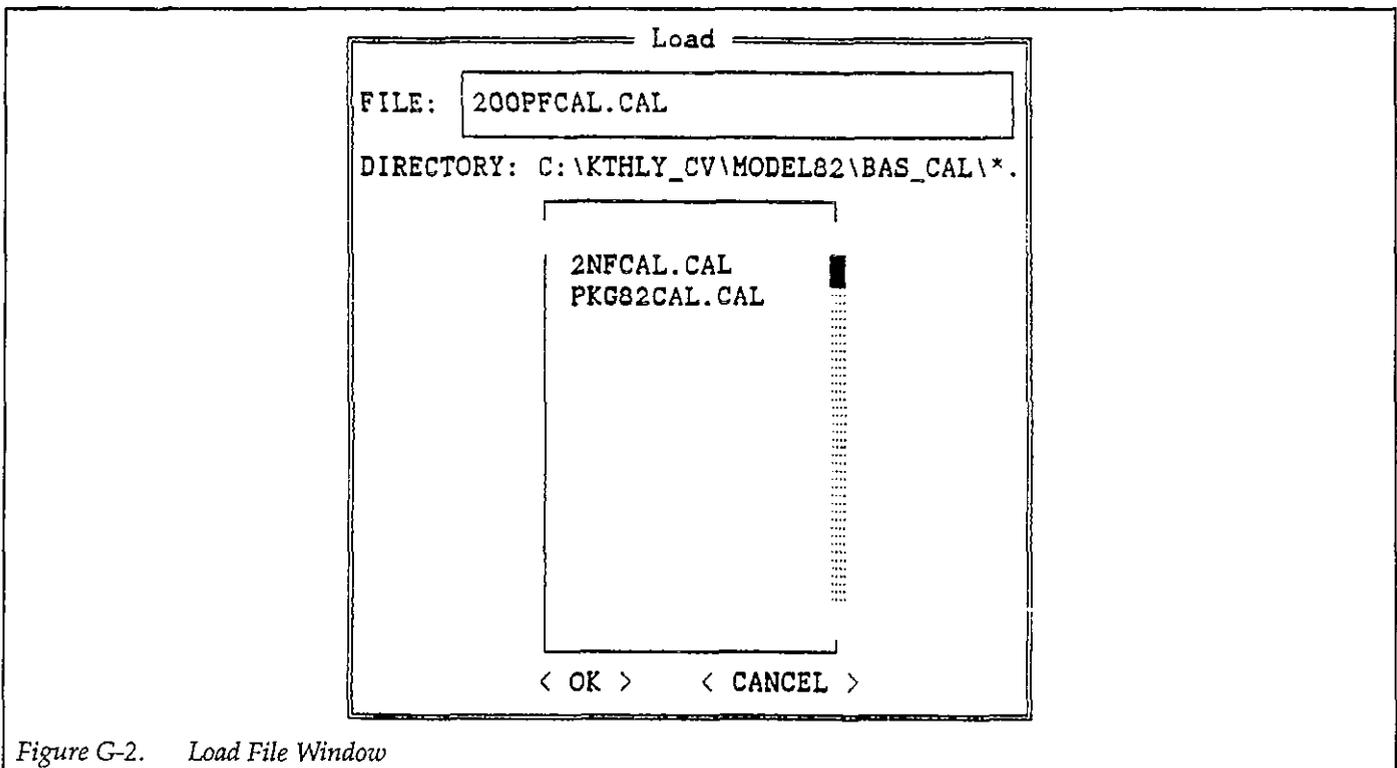

Figure G-2. Load File Window

NOTE

All cable correction constants files must have a .CAL extension.

DOS Shell

This selection suspends program operation (without losing data), allowing you to execute DOS commands or to run other programs (memory permitting). Type EXIT <Enter> to return to CABLECAL.EXE from the DOS shell.

Exit

Exits to the DOS prompt. Note that you will be warned if data has not been saved.

EXECUTE

Set IEEE Address

Selecting this item displays the window shown in Figure G-3 and allows you to set the IEEE-488 primary addresses for the Models 230-1, 590, and 595. Each instrument must have a unique address, which must be in the range of 0-30. Selecting OK accepts the changes, and Cancel exits the window without changing previous addresses.

Send DDC

The Send DDC selection allows you to send a DDC (device-dependent command) to a device with the specified primary address (Figure G-4). To use this feature, first select the primary address, enter your DDC, then select OK. Selecting Cancel closes the window.

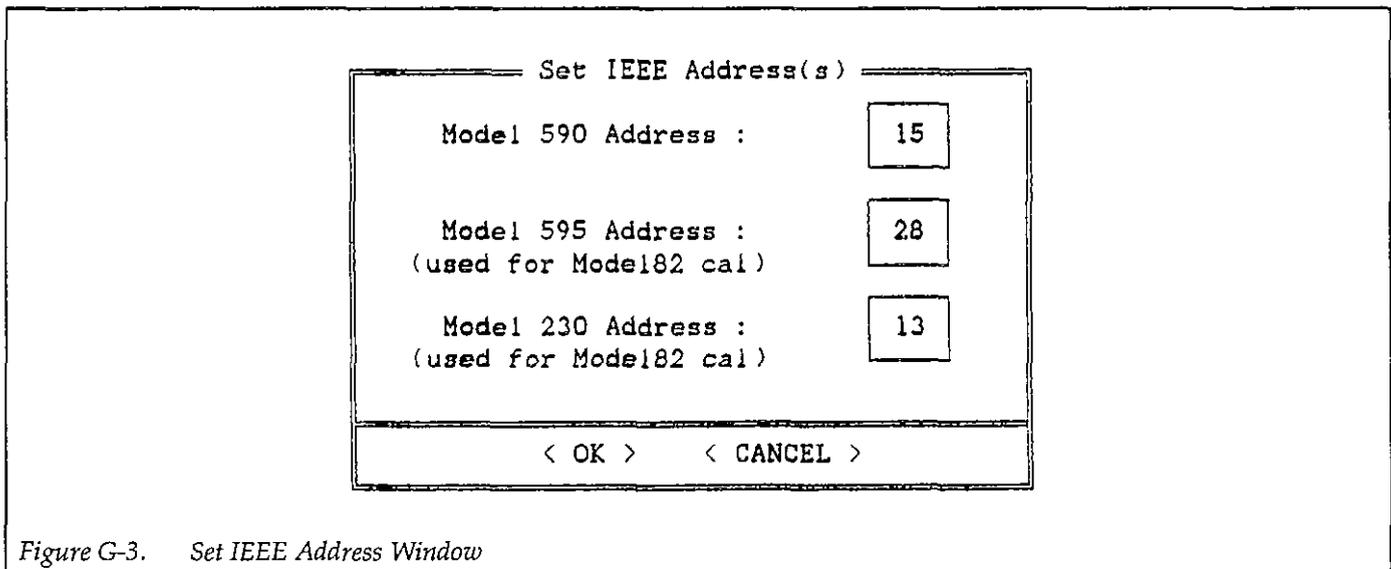

Figure G-3. Set IEEE Address Window

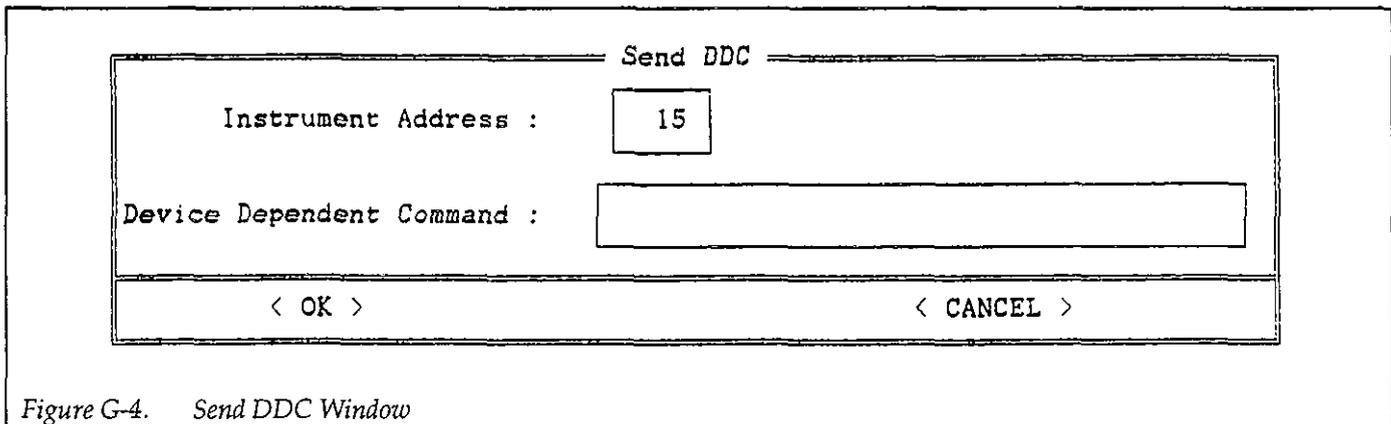

Figure G-4. Send DDC Window

Cable Cal 590: 2pF (20pF, 200pF, 2nF) Range

These four selections allow you to individually calibrate the 2pF, 20pF, 200pF, and 2nF ranges of the Model 590. In order to calibrate the 2pF and 2nF ranges, you will need additional calibration capacitors not supplied with the Model 5909 Calibration Sources that are supplied with Model 82-DOS.

At the start of the calibration process, a window similar to the one shown in Figure G-5 will be displayed. Enter the two capacitor values for each range where indicated. Note that 1kHz values are not required for Model 590 and the corresponding fields are disabled. Also, no 2pF, 1MHz range calibration is required because the Model 590 has no such range.

After entering your values, select OK to complete the entry process. Error checking will be performed to make sure the entered values are within the required limits, and that Capacitor #1 values are less than Capacitor #2 values.

If all values are within required limits, the window shown in Figure G-6 will be displayed. If you wish to perform cable calibration, select the CALIBRATE option, then follow the prompts on the screen. If, on the other hand you wish to simply send existing calibration constants in memory to the Model 590, select SEND CONSTANTS. If no constants are in memory, an error message will be displayed.

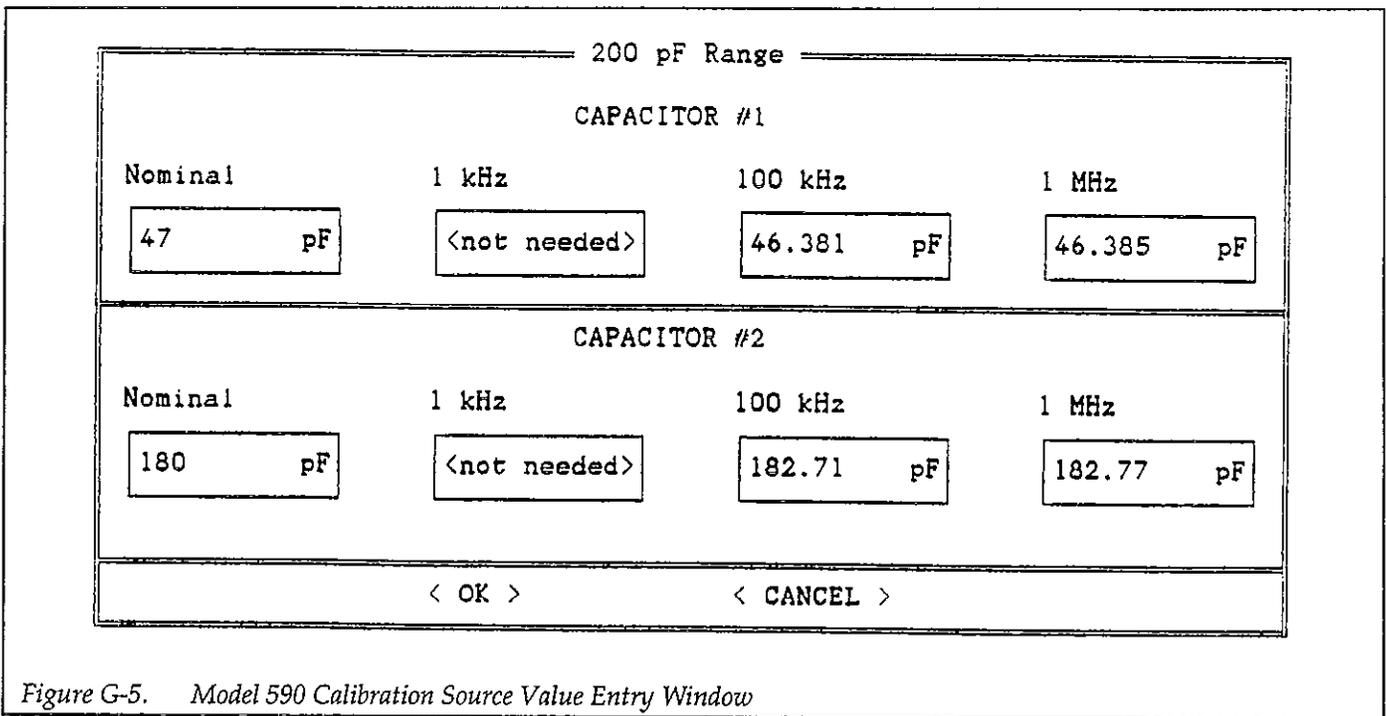

Figure G-5. Model 590 Calibration Source Value Entry Window

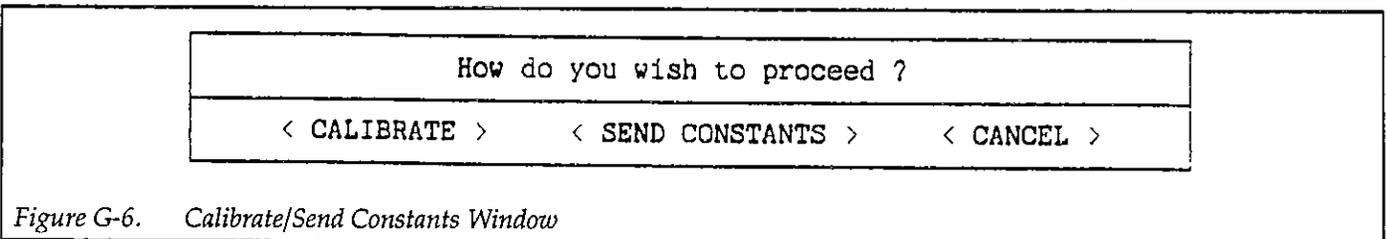

Figure G-6. Calibrate/Send Constants Window

Cable Cal Model 82

This selection performs cable calibration of the Model 82-DOS system.

At the start of the calibration process, a window similar to the one shown in Figure G-7 will be displayed. Enter the two capacitor values for the 200pF and 2nF ranges where indicated. Note that 1kHz, 100MHz, and 1MHz values are required and that Capacitor #1 is the smaller value, and Capacitor #2 is the larger value.

After entering your values, select OK to complete the entry process. Error checking will be performed to make sure the entered values are within the required limits, and that Capacitor #1 values are less than Capacitor #2 values.

If all values are within required limits, the window shown in Figure G-6 will be displayed. If you wish to perform cable calibration, select the CALIBRATE option, then follow the prompts on the screen. If, on the other

hand you wish to simply send existing calibration constants in memory to the Model 590, select SEND CONSTANTS. If no constants are in memory, an error message will be displayed.

NOTE

The calibration constants sent to the Model 590 with a Cable Cal Model 82 SEND CONSTANTS OPERATION are different from the calibration constants sent to the Model 590 with a Cal Model 590 SEND CONSTANTS OPERATION. All Model 82 Cal data and Model 590 Cal Range Data are mutually exclusive of one another.

HELP

The Help menu selections provides online instructions for using the cable calibration pages of program. Use Page Up and Page Down to scroll through help information, or use up arrow or down arrow to scroll through line-by-line.

MODEL 82: 200 pF Range				
CAPACITOR #1				
Nominal	1 kHz	100 kHz	1 MHz	
47 pF	46.3864 pF	46.381 pF	46.385 pF	
CAPACITOR #2				
Nominal	1 kHz	100 kHz	1 MHz	
180 pF	182.732 pF	182.71 pF	182.77 pF	
< OK >		< CANCEL >		

Figure G-7. Model 82 Calibration Source Value Entry Window

MODEL 82-DOS CABLE CALIBRATION PROCEDURE

1. While in the \KTHLY_CV\MODEL82 directory, type in the following to run the cable calibration utility:

CABLECAL <Enter>

2. To Load an existing calibration constants file, press Alt-F, then select Load on the menu. Select the existing file, or type in the name of the file (select PKG82CAL.CAL for Model 82-DOS).
3. Press Alt-E, then select Cable Cal Model 82 to calibrate the Model 82-DOS system.
4. If you are cable correcting your system for the first time, enter the nominal, 1kHz, 100kHz, and 1MHz values where indicated (use the <Tab> key to move around selections). Capacitor #1 is the smaller of two values, and Capacitor #2 is the large capacitor value for a given range. Select OK after entering source values to begin the calibration process.
5. Choose the CALIBRATE selection to perform complete cable calibration.
6. Follow the prompts on the screen to complete the calibration process. During calibration, you will be prompted to connect calibration capacitors, or to leave the terminals open in some cases. If any errors occur, you will be notified by suitable messages on the screen.
7. After calibration is complete, you must save the new calibration constants to the PKG82CAL.CAL in order for the Model 82-DOS main program to find them at run time. To do so, Press Alt-F, then select Save or Save As as required. If you use Save As, be sure to use the PKG82CAL.CAL filename.

MODEL 590 CABLE CALIBRATION PROCEDURE

1. While in the \KTHLY_CV\MODEL82 directory, type in the following to run the cable calibration utility:

CABLECAL <Enter>

2. To Load an existing calibration constants file, press Alt-F, then select Load on the menu. Select an existing file, or type in the name of the file.
3. Press Alt-E, then select Cable Cal 590 and the desired range.

4. If you are cable correcting your system for the first time, enter the nominal, 100kHz, and 1MHz values where indicated (use the Tab key to move around selections). Capacitor #1 is the smaller of two values, and Capacitor #2 is the large capacitor value for a given range. Select OK after entering source values to begin the calibration process.
5. Choose the CALIBRATE selection to perform complete cable calibration.
6. Follow the prompts on the screen to complete the calibration process. During calibration, you will be prompted to connect calibration capacitors, or to leave the terminals open in some cases. If any errors occur, you will be notified by suitable messages on the screen.
7. After calibration is complete, you must save the new calibration constants. To do so, Press Alt-F, then select Save or Save As as required. If you use Save As, be sure to use a filename with a .CAL extension.

SENDING EXISTING CONSTANTS

1. From the \KTHLY_CV\MODEL82 directory, type in the following:

CABLECAL <Enter>

2. Press Alt-F, then select Load.
3. Load the file that contains the constants to be sent.
4. Press Alt-E, then select Cable Cal 590 or Cable Cal Model 82 as required.
5. If all source values are acceptable, select OK.
6. Select SEND CONSTANTS to send the constants in memory to the Model 590.

CABLE CALIBRATION FILE FORMAT

Figure G-8 shows the calibration file generated by any of the Cable cal 590 menu selections (the format for the Cable Cal Model 82 selection is different and is not presented here). This format is compatible with the Model 5958 C-V Utilities software and is presented here for those who wish to customize their own calibration files. Note that "UNCAL" appears in a field for a range that has not been calibrated.

Table G-1 describes each field in the file.

```

"2 pf Range"
"-----"
"0.0E-12"
"0.0E-12"
"0.0E-12"
"0.0E-12"
"UNCAL"
"20 pf Range"
"-----"
"0.0E-12"
"0.0E-12"
"0.0E-12"
"0.0E-12"
"0.0E-12"
"0.0E-12"
"UNCAL"
"UNCAL"
"200 pf Range"
"-----"
"47E-12"
"46.381E-12"
"46.385E-12"
"180E-12"
"182.71E-12"
"182.77E-12"
"CCP 0 4.1974E-04 9.9903E-01 5.5781E+00 -1.3368E+00"
"CCP 0 2.2992E-03 9.9398E-01 4.3320E+00 -3.3043E-01"
"2 nf Range"
"-----"
"0.0E-12"
"0.0E-12"
"0.0E-12"
"0.0E-12"
"0.0E-12"
"0.0E-12"
"UNCAL"
"UNCAL"

```

Figure G-8. Calibration File Format

Table G-1. Calibration File Format Description

Line	Field Contents
1	"2 pF Range"
2	"-----"
3	(cap #1 nominal value)
4	(cap #1 100kHz value)
5	(cap #2 nominal value)
6	(cap #2 100kHz value)
7	(2pF/100kHz calibration DDC)
8	"20pF Range"
9	"-----"
10	(cap #1 nominal value)
11	(cap #1 100kHz value)
12	(cap #1 1MHz value)
13	(cap #2 nominal value)
14	(cap #2 100kHz value)
15	(cap #2 1MHz value)
16	(20pF/100kHz DDC)
17	(20pF/1MHz DDC)
18	"200pF Range"
19	"-----"
20	(cap #1 nominal value)
22	(cap #1 100kHz value)
23	(cap #1 1MHz value)
24	(cap #2 nominal value)
25	(cap #2 100kHz value)
26	(cap #2 1MHz value)
27	(200pF/100kHz DDC)
28	(200pF/1MHz DDC)
29	"2nF Range"
30	"-----"
31	(cap #1 nominal value)
32	(cap #1 100kHz value)
33	(cap #1 1MHz value)
34	(cap #2 nominal value)
35	(cap #2 100kHz value)
36	(cap #2 1MHz value)
37	(2nF/100kHz DDC)
38	(2nF/1MHz DDC)

APPENDIX H

File Merge Utility

DESCRIPTION

The file merge utility, FILEMRG.EXE, will merge data from separate quasistatic and high-frequency C-V files into a third file that can be analyzed as though data were taken simultaneously. Quasistatic data generated in this manner will benefit from a substantial noise reduction resulting from the fact that the Model 5951 Remote Input Coupler is not in the circuit when data is taken. Such noise reduction can be particularly important with small devices because of noise inherent in the data.

The basic procedure involves using the KI595CV.EXE program to perform a quasistatic C-V sweep, and then using the KI590.EXE program to perform a high-frequency C-V sweep. The two data files are then merged with the FILEMRG.EXE utility, and merged data can then be analyzed by using the KI82CV.EXE program.

FILE MERGE UTILITY OPERATION

The file merge utility does not merely combine capacitance data from the quasistatic and high-frequency C-V files into a third file because the corresponding capacitance measurements are not made at exactly the same voltages, even if the start, stop, and step voltages for the two sweeps are the same. In order to compensate for this

voltage offset, a quadratic interpolation is performed. With the quasistatic voltage values acting as reference points, the high-frequency voltage values are interpolated to map into the corresponding quasistatic voltage data points. The result of this interpolation is that the voltage and quasistatic capacitance data points in the merged file correspond exactly to the voltage and capacitance data points in the quasistatic file. The high-frequency data points in the merged file will be somewhat different than the capacitance data points in the original high-frequency C-V file since the new data points have been interpolated.

FILE CONSTRAINTS

In order to ensure accurate interpolation, two important constraints should be kept in mind when using the file merge utility:

1. The high-frequency and quasistatic sweeps must have the same start voltage.
2. The step voltages for the quasistatic and high-frequency sweeps must either be exactly the same, or the high-frequency step voltage must be exactly twice as large as the quasistatic step voltage.

The following two cases will demonstrate how the number of readings in the output file is determined.

Case 1: High-frequency Step Voltage = Quasistatic Step Voltage

In this case, the maximum number of readings in the output file is equal to the number of readings in the high-frequency data file divided by a factor of two. If there are not twice as many high-frequency readings as quasistatic readings (for example, if the stop voltages are different), the number readings in the output file will be equal to the number of quasistatic readings. The examples below demonstrate the process.

Example 1: Number of high-frequency readings: 100
Number of quasistatic readings: 50
Number of output file readings: 50

Example 2: Number of high-frequency readings: 100
Number of quasistatic readings: 35
Number of output file readings: 35

Example 3: Number of high-frequency readings: 100
Number of quasistatic readings: 75
Number of output file readings: 50

Case 2: High-frequency Step Voltage = Twice the Quasistatic Step Voltage

In this case, the number of output data file readings will be determined by the smaller of the high-frequency or quasistatic reading count, as in the examples below.

Example 1: Number of high-frequency readings: 100
Number of quasistatic readings: 66
Number of output file readings: 66

Example 2: Number of high-frequency readings: 70
Number of quasistatic readings: 120
Number of output file readings: 70

Example 3: Number of high-frequency readings: 100
Number of quasistatic readings: 100
Number of output file readings: 100

Note that there are no constraints on filtering or stop voltages, and the file merge utility halts when it can no longer interpolate the data. Also, constants stored in the merged

output file are taken from the high-frequency C-V file rather than the quasistatic C-V file.

RUNNING THE FILE MERGE UTILITY

Running the file merge utility is simply a matter of typing the FILEMRG program name at the DOS prompt along with the quasistatic filename, high-frequency filename, and the output filename:

```
FILEMRG <595 filename> <590 filename> <output filename> <Enter>
```

Note that you can include path information for any of the filenames, if desired.

For example, assume that you have a quasistatic (Model 595) called CQ.DAT and a high-frequency file, CH.DAT, that you wish to merge into a file called TEST.DAT. The command line syntax is:

```
FILEMRG CQ.DAT CH.DAT TEST.DAT <Enter>
```

To specify different paths, you could add:

```
FILEMRG C:\MYDAT\CQ.DAT C:\MYDAT  
\CH.DAT TEST.DAT
```

Once the program is started, any further input will be requested by a pop-up window. You can use either the <Tab> key or a compatible mouse to move around the window. All errors are fatal, which means that an error message will be displayed, and the program will terminate. Typical errors include not being able to find a specified file or trying to merge incompatible files. For example, if the program is started without specifying data filenames, the error window shown in Figure H-1 will be displayed.

OUTPUT FILE HEADER

During the merge operation, you will be given an opportunity to enter input header test information that will be included in the output file (Figure H-2). While entering this text, you can use the <Home>, <End>, <Insert>, and <Delete> keys.

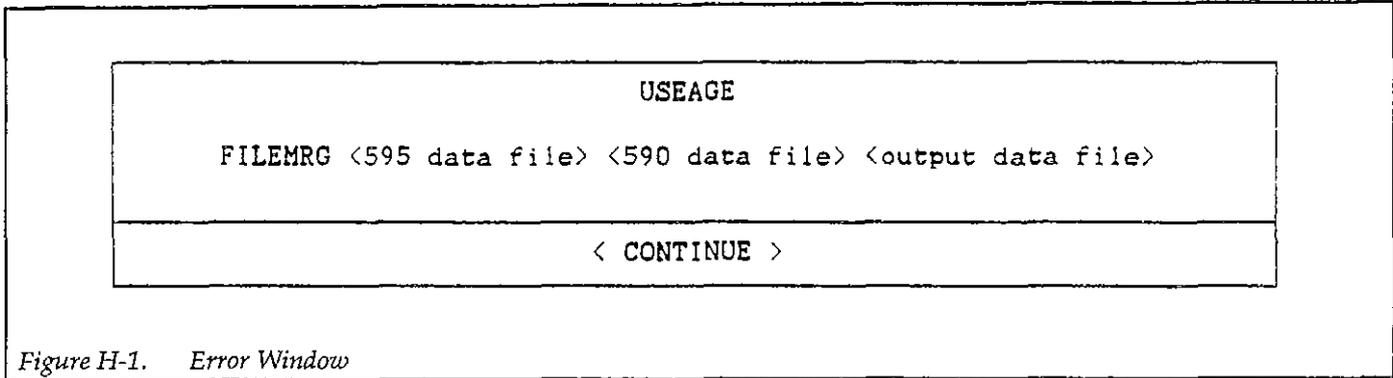

Figure H-1. Error Window

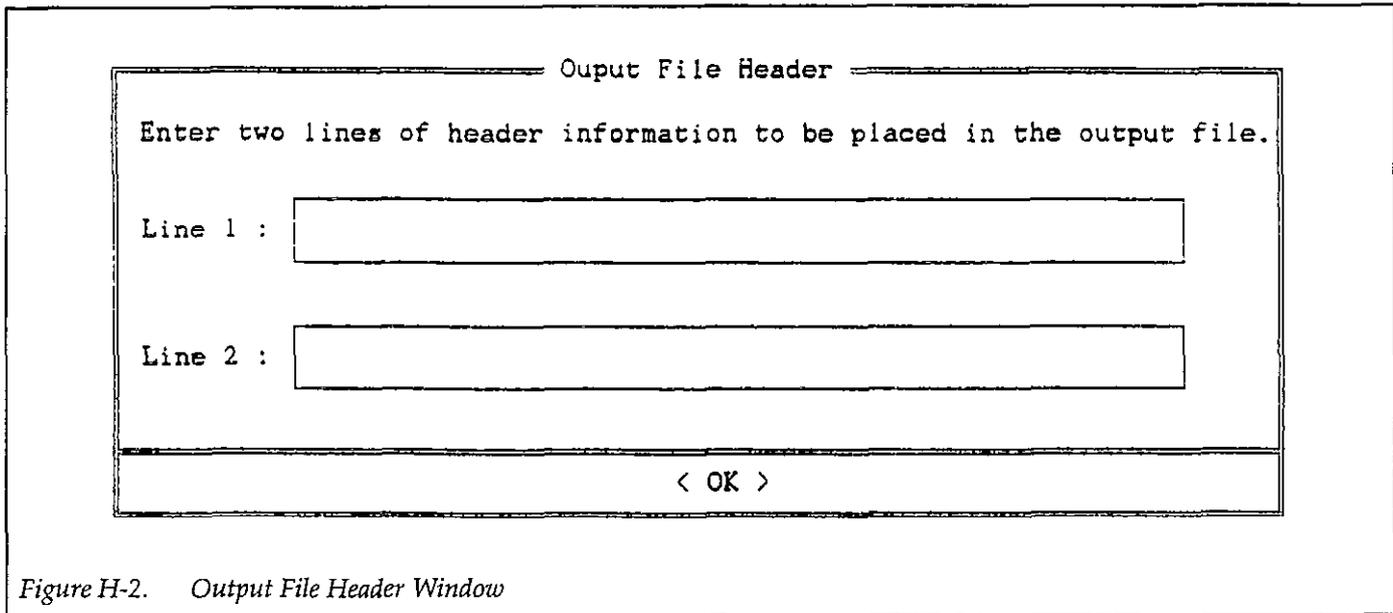

Figure H-2. Output File Header Window

FILE MERGE PROCEDURE

1. Using the KI595CV.EXE program, measure and store a data file of quasistatic C-V sweep data.
2. Using the KI590CV.EXE program, or the Model 5958 C-V Utilities, measure and store a data file of high-frequency C-V data. Remember that the start voltages for the two sweeps must be the same, and that the step voltages must be the same or the high-frequency step voltage can be exactly twice as large as the quasistatic step voltage.
3. Merge the two files by typing in the following from the DOS prompt:

FILEMRG <File1> <File2> TEST.DAT <Enter>

Here File1 and File2 are the files stored in steps 1 and 2.
4. Once the merge operation has been successfully completed, you can use the KI82CV.EXE program to analyze the data in the usual manner. Refer to Section 4 for analysis details.

APPENDIX I

Data File Format

EXAMPLE FILE FORMAT

An example of the Model 82-DOS data file format is shown in Figure I-1. In this example, spaces are used as data delimiters (the delimiter is selected when the data is saved). Various lines in the file are summarize below.

Line 1: Contains the information from the two header lines used to identify the graph. NOTE: Header information may print out as one or two lines depending on the number of characters and the method used to display the file.

Line 2: Identifies the file as a Model 5957 file.

Line 3: Indicates the type of data delimiter selected when the file was saved (comma, space, tab).

Lines 4-32: Store various constants used by the program. NOTE: Constants labelled "Qmi" through "Vth-" are not used by Model 82-DOS but are included for compatibility with the Model 5958 C-V Utilities.

Line 33: Identifies each column of reading and graphics array data below.

Lines 34-: Lines of reading and graphics array data. The number of lines will, of course, depend on the number of samples in the measurement.

IMPORTING DATA INTO OTHER PROGRAMS

Since Model 82-DOS data files are stored in ASCII format, these files can be imported into many spreadsheet and word processing programs by choosing the proper data delimiter. Compatible delimiters for typical programs include:

Lotus 1-2-3: Tab, space, or comma

Microsoft Excel: Tab

Word processors: Tab or space

Typically, Model 82-DOS data can be imported into spreadsheets by using the retrieve numbers or import numbers option of the spreadsheet program. Data can be imported into word processors using the ASCII option if one is available.

Example: Assume that you have a data file called WAFER1.DAT stored on disk that you want to save in a compatible Lotus 1-2-3 format in the Lotus data directory called C:\LOTUS123\DATA. The following procedure demonstrates the process.

1. From the analysis menu, select Load.
2. Type in the name of the data file to load (WAFER1.DAT in this example).
3. Select Save on the analysis menu.
4. Type in the complete path name, including the file-name with the new extension. For our current example, the complete path would be:
5. At the prompt, select a comma data delimiter.
6. After saving the file, exit the Model 82-DOS program, then run the Lotus 1-2-3 program.
7. Select the retrieve numbers option, then load the WAFER1.DAT file. Separate numbers and array elements will be placed into individual cells.

C:\LOTUS123\DATA\WAFER1.DAT <Enter>

```

"Example line #1
5957
"SPACE"
"Rdgcnt=" 114
"Frequency=" 1000000
"Model=" 1
"GStepv=" 50
"Rseries=" .44
"Cox=" 250.6
"Tox=" 135.6744
"Area=" 9.99999977648258D-03
"Nbulk=" 839999972966400
"Cmin=" 73.7
"CqGain=" 1
"CqOffset=" 0
"ChGain=" 1
"ChOffset=" 0
"Cfb=" 0
"Vfb=" 0
"Lb=" 0
"Qeff=" 0
"Neff=" 0
"Vth=" 0
"Navg=" 0
"WorkFn=" 0
"PhiB=" 0
"Qmi=" 0
"Qss=" 0
"Nmi=" 0
"Nss=" 0
"Vfb+=" 0
"Vfb-=" 0
"Vth+=" 0
"Vth-=" 0
"DevType=" ""
"Cq" "Iq" "Ch" "Gh" "Vh" "W" "N" "ZW" "ZN" "Psis" "Et" "Dit" "InvSqCh" "ACq" "ACh"
249.7249 -.18 250.6 1.1 5.84 0 0 0 0 0 0 0 0 0 0 0
250.1866 -.18 250.5 1.1 5.74 0 0 0 0 0 0 0 0 0 0 0
250.4062 -.18 250.5 1.1 5.64 0 0 0 0 0 0 0 0 0 0 0
250.5384 -.18 250.4 1.1 5.54 0 0 0 0 0 0 0 0 0 0 0
250.6108 -.18 250.4 1.1 5.44 0 0 0 0 0 0 0 0 0 0 0
250.7106 -.18 250.3 1.1 5.34 0 0 0 0 0 0 0 0 0 0 0
250.6258 -.18 250.4 1.1 5.23 0 0 0 0 0 0 0 0 0 0 0
250.4461 -.19 250.2 1.1 5.14 0 0 0 0 0 0 0 0 0 0 0

```

Figure I-1. Data File Format

APPENDIX J

Software Modification

INTRODUCTION

The C-V programs supplied with Model 82-DOS need no modifications to run. However, in some cases, you may desire to make changes to the software to customize it for your specific needs. For example, you may wish to change analysis formulas. (All analysis formulas are located in the GrafDataPart1 () function located in module P82SUBA1.BAS.)

COMPILING SOURCE CODE

Since the C-V programs were compiled under Microsoft BASIC 7.1, it will be necessary for you to edit, recompile, and relink the desired program using BASIC 7.1 if any changes are required. Source code for the programs are broken up into numerous files, each of which has the .BAS extension.

The general procedure below should be followed to modify the software.

1. Install BASIC 7.1 using the supplied SETUP utility (Setup Disk #1).
2. With the C:\BC7\BIN subdirectory selected, type in the following to enter the BASIC editor:

QBX <Enter>

3. LOAD the desired source module into the editor, then save it as a backup file.
4. Edit the source file as required. The FIND option under the Search menu will be helpful in locating specific code.
5. After you modified the module to your satisfaction, SAVE it under the same filename (note that doing so will overwrite the previous version of that particular module).
6. Repeat steps 3 through 5 for all modules you intend to modify.
7. After all modules have been modified, exit BASIC, and return to DOS.
8. From DOS, type in the following to compile and link a new executable program:

MAKE KI82 <Enter>

(or use MAKE KI90 or MAKE KI95 if you are modifying those programs). All the separate modules will be separately compiled, and then linked. The time required for this option will depend on the speed of your computer. A typical time for an 8MHz 286-based machine is about five minutes for the entire operation. Once the process has been completed, you can run the modified program in the usual manner.

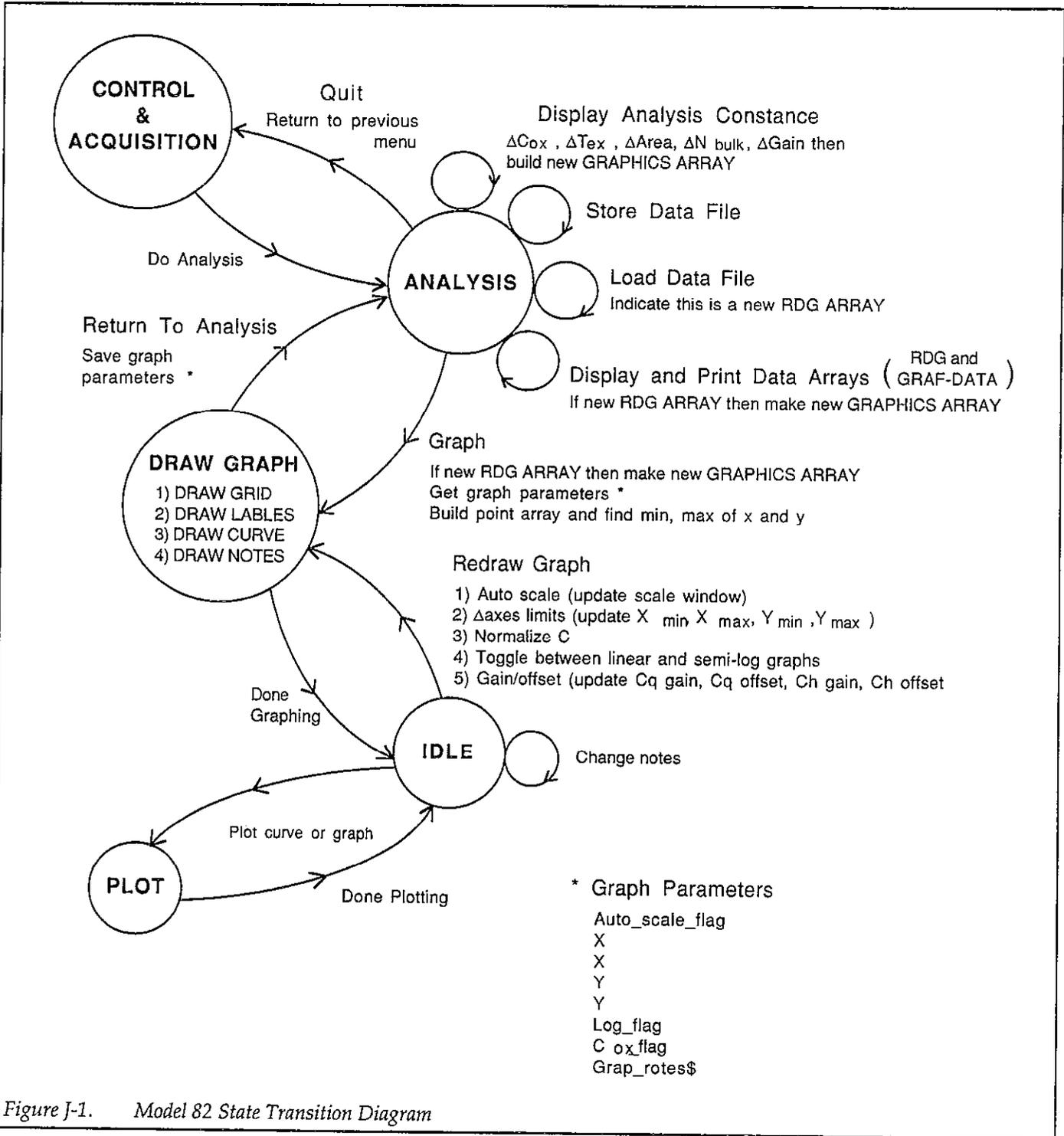

Figure J-1. Model 82 State Transition Diagram

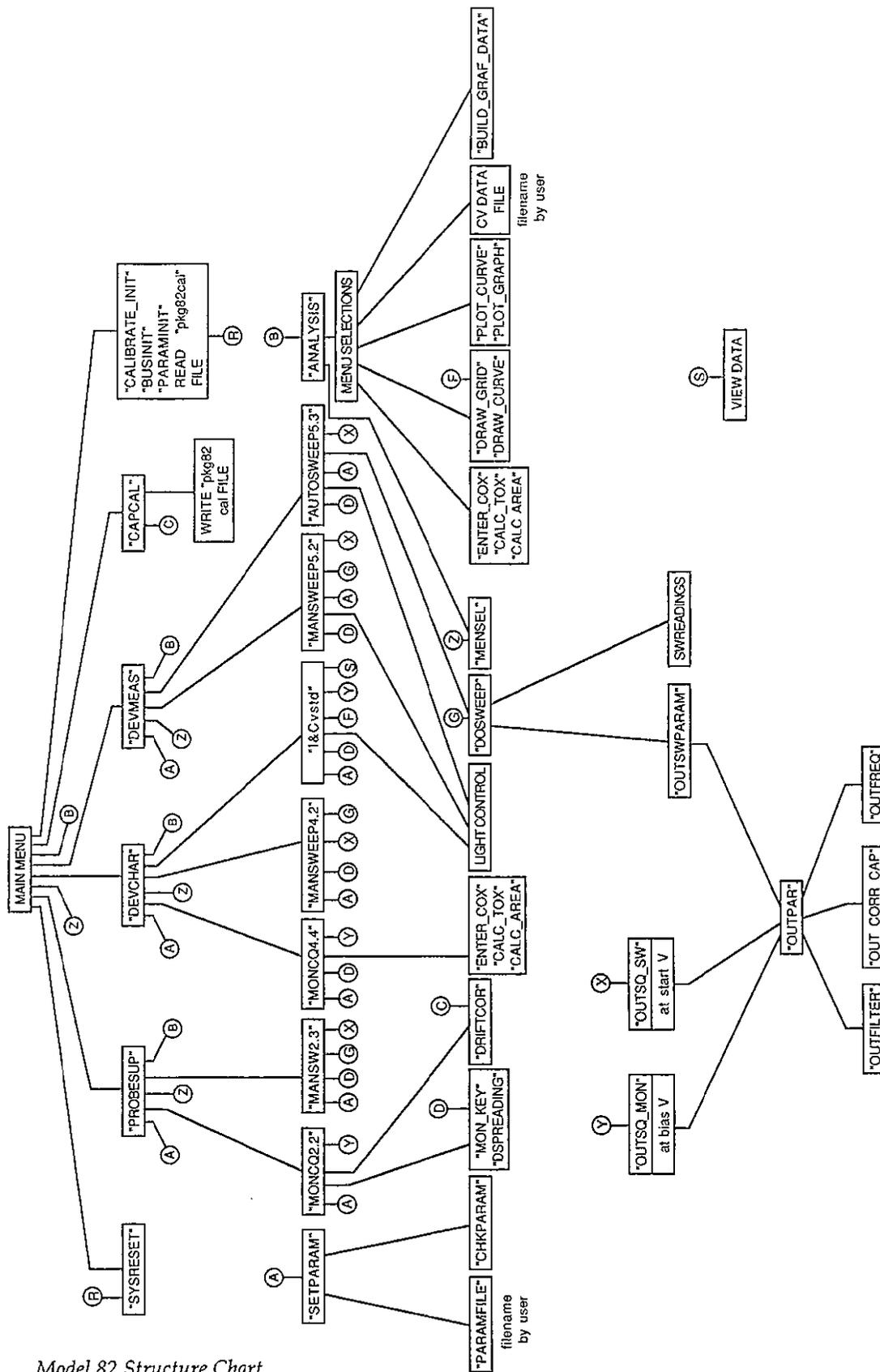

Figure J-2. Model 82 Structure Chart

Index

A

ANALYSIS CONSTANTS, 4-10
ANALYZING C-V DATA, 4-4
Analysis, 4-1
Analysis Constants, B-1
Analysis Menu, 4-5
Analysis Tools, 4-17
Analyzing Curves for Equilibrium, 3-39
Auto C-V Sweep, 3-31
Average Doping Concentration, 4-16
Avoiding Capacitance Errors, 3-37

B

Band Bending vs. Gate Voltage (ψ_s vs. V_{GS}), 4-31
Basic C-V Curves, 4-3
Best Depth, 4-16
BIBLIOGRAPHY FOR MATERIAL.CON, A-5
Bibliography of C-V Measurements and Related Topics, 4-40

C

C-V Measurement Menu, 3-25
Cable Calibration Utility, G-1
Cabling Considerations, 3-37

Calculated Data Symbols, 4-2
CHARACTERIZING DEVICE PARAMETERS, 3-15
Changing C_{MDN} , 4-14
Changing Device Constants, 4-20
Changing N_{BULK} , 4-14
Checkout Procedure, 2-17
COMPILING SOURCE CODE, J-1
COMPONENT LAYOUTS AND SCHEMATIC DIAGRAMS, 6-1
COMPUTER HARDWARE AND SOFTWARE INSTALLATION, 2-9
COMPUTER REQUIREMENTS, 1-3
CONFIG.SYS Modification, 2-12
CONSTANTS AND SYMBOLS USED FOR ANALYSIS, 4-1
CORRECTING FOR CABLING EFFECTS, 3-13
Compensation for Series Resistance and Determining Device Parameters, 2-15
Connecting Cables, 1-5
Correcting Residual Errors, 3-38
Correction Procedure, 3-15
Cursor Operation, 4-19
Curve Misalignment, 3-38

D

Data Analysis and Plotting, 2-17

Data File Format, I-1
Default Constants, 4-1
Depletion Concentration vs. Depth (N vs. w), 4-26
Determining C_{MIN} and Optimum Delay Time, 3-21
Determining Device Type, 4-4
Determining Series Resistance, Oxide Capacitance, Oxide Thickness, and Gate Area, 3-19
Device Characterization Menu, 3-15
Device Connections, 3-37
Device Considerations, 3-42
Device Integrity, 3-42
Device Measurement, 2-16
Device Structure, 3-42
Digital I/O Port Terminals, 3-33
Displaying and Printing the Reading and Graphics Arrays, 4-6
Doping Profile, 4-26
Dynamic Range Considerations, 3-40

E

Effective Oxide Charge, 4-15
Effective Oxide Charge Concentration, 4-16
Environmental Conditions, 2-8

F

FACTORY SERVICE, 6-1
FEATURES, 1-1
FILE CONSTRAINTS, H-1
FILE MERGE PROCEDURE, H-3
FILE MERGE UTILITY OPERATION, H-1
File Merge Utility, H-1
Flatband Capacitance and Flatband Voltage, 4-14
Flatband Voltage Shift Method, 4-36
Frequency Control, 5-3

G

Gain and Nonlinearity Errors, 3-38
Gain and Offset, 4-17
General Information, 1-1
Getting Started, 2-1
GRAPHICAL ANALYSIS, 4-17
Graphic 4.0 Functions Used by Model 82-DOS, F-1
Graphics Array, 4-20
Graphics Array Structure, 4-20
Graphics Cards, 1-3
Graphing Data, 4-18
Graphing the Reading Array, 4-20

H

HARDWARE CONFIGURATION, 2-1
HIGH FREQUENCY C-V, 5-5
High Frequency System Configuration, 5-5
High-Frequency Effects, 3-36
High-Frequency Measurements, 5-5

I

IEEE-488 Bus Connections, 2-6
IEEE-488 Driver Software Installation, 2-12
IEEE-488 Interfaces, 1-3
IMPORTING DATA INTO OTHER PROGRAMS, I-1
Initial Equilibrium, 3-40
Installation Verification, 2-12
Instrument Power Requirements, 2-8
Interface Card Installation, 2-9
Interface Trap Density Analysis, 4-31
Interface Trap Density vs. Energy from Midgap (DIT vs. ET), 4-34
Interpreting C-V Curves, 3-38

Invalid Array Values, 4-20

L

LED Connections, 3-33
Leakage Resistances, 3-36
LIGHT CONNECTIONS, 3-33
Light Leaks, 3-43
Line Frequency, 2-9
Loading Data, 4-6

M

MAKING C-V MEASUREMENTS, 3-25
MANUAL ADDENDA, 1-2
Maintaining Equilibrium, 3-38
Manual C-V Sweep, 3-29
Material Constants File Modification, A-1
MEASUREMENT CONSIDERATIONS, 3-35
MEASUREMENT SEQUENCE, 3-1
Measurement, 3-1
Measurement Method, 5-3
Memory and Hard Disk Considerations, 2-10
Metal Semiconductor Work Function Difference, 4-15
MOBILE IONIC CHARGE CONCENTRATION MEASUREMENT, 4-35

N

Noise, 3-38

O

OBTAINING INFORMATION FROM BASIC V-V CURVES, 4-3
Offset Suppression, 3-13
Offsets, 3-38
OPTIONAL ACCESSORIES, 1-5
Optimizing Correction Accuracy to Probe Tips, 3-15
ORDERING INFORMATION, 6-1
OUTPUT FILE HEADER, H-2
Overlaying Curves, 4-19
Oxide Capacitance, Thickness, and Area Calculations, 4-12

P

PARTS LIST, 6-1

Plotter and Printer Considerations, 2-13
Plotter and Printer Requirements, 4-4
Plotter Size, 4-19
Potential Error Sources, 3-35
Power Connections, 2-8
Power Up Procedure, 2-8
Prefixes of Unit Values, D-1
Principles of Operation, 5-1
Printer Size and Resolution, 4-19
Printers and Plotters, 1-4
Programming Measurement Parameters, 3-25

Q

QUASISTATIC C-V, 5-3
Quasistatic C-V Configuration, 5-3

R

Rack Mount Kits, 1-5
Raw Data Symbols, 4-2
REFERENCES AND BIBLIOGRAPHY OF C-V MEASUREMENTS AND RELATED TOPICS, 4-40
REMOTE INPUT COUPLER, 5-1
Reading Array, 4-19
Recommended Sources, 3-14
Relay Control, 3-33
Remote Coupler Mounting, 2-6
Remote Input Coupler, 2-2
Replaceable Parts, 6-1
Returning to DOS, 2-17
RUNNING THE FILE MERGE UTILITY, H-2
Running and Analyzing a Diagnostic C-V Sweep, 3-17

S

SAFETY SYMBOLS AND TERMS, 1-2
Saving and Recalling Data, 4-5
Saving the Data, 4-6
SERVICE AND CALIBRATION, 1-5
Selecting Optimum C-V Measurement Parameters, 3-29
Selecting the Graphics Range, 4-7
Series and Parallel Model Equivalent Circuits, 3-41
Series Resistance, 3-42
Series Resistance Calculations, 4-12
SOFTWARE OVERVIEW, 2-15
Software backup, 2-9
Software Modification, J-1

Software Utilities, 1-5
Source Connections, 3-14
SPECIFICATIONS, 1-2
STARTING CABLECAL.EXE, G-1
Stray Capacitances, 3-35
Summary of Analysis Equations, C-1
Supplied Equipment, 1-2
SYSTEM BLOCK DIAGRAM, 5-1
SYSTEM CHECKOUT, 2-17
SYSTEM POWER UP, 2-8
SYSTEM RESET, 3-3
System Block Diagram, 2-1
System Characterization, 2-15
System Connections, 2-5
System Leakage Test Sweep, 3-10
System Reset, 2-15
System Software Requirements, 1-4

System Troubleshooting, 2-17

T

TESTING AND CORRECTING FOR SYSTEM
LEAKAGES AND STRAYS, 3-4
Test Equipment Considerations, 3-43
Test Fixture Shielding, 3-37
Thermal Errors, 3-43
Threshold Voltage, 4-14
Threshold Voltage and Flatband Voltage Display, 4-19
Triangular Voltage Sweep Method, 4-36
Tuned Circuits, 5-3

U

UNPACKING AND INSPECTION, 1-2

USING THE MODEL 590 PROGRAM, E-1
USING THE MODEL 595 PROGRAM, E-1
Using Corrected Capacitance, 3-31
Using Effective Charge to Determine Mobile Ion Drift, 4-40
Using the Model 590 and 595 Programs, E-1

V

V_{FB} and ϕ_0 Interpolation, 4-34
Viewing Leakage Levels, 3-8
Voltage-dependent Offset, 3-38

W

WARRANTY INFORMATION, 1-2
Warm Up Period, 2-8



Service Form

Model No. _____ Serial No. _____ Date _____

Name and Telephone No. _____

Company _____

List all control settings, describe problem and check boxes that apply to problem. _____

- | | | |
|--|--|--|
| <input type="checkbox"/> Intermittent | <input type="checkbox"/> Analog output follows display | <input type="checkbox"/> Particular range or function bad; specify |
| <input type="checkbox"/> IEEE failure | <input type="checkbox"/> Obvious problem on power-up | <input type="checkbox"/> Batteries and fuses are OK |
| <input type="checkbox"/> Front panel operational | <input type="checkbox"/> All ranges or functions are bad | <input type="checkbox"/> Checked all cables |

Display or output (check one)

- | | |
|-----------------------------------|--|
| <input type="checkbox"/> Drifts | <input type="checkbox"/> Unable to zero |
| <input type="checkbox"/> Unstable | <input type="checkbox"/> Will not read applied input |
| <input type="checkbox"/> Overload | |

- | | |
|---|--|
| <input type="checkbox"/> Calibration only | <input type="checkbox"/> Certificate of calibration required |
| <input type="checkbox"/> Data required | |

(attach any additional sheets as necessary)

Show a block diagram of your measurement system including all instruments connected (whether power is turned on or not). Also, describe signal source.

Where is the measurement being performed? (factory, controlled laboratory, out-of-doors, etc.)

What power line voltage is used? _____ Ambient temperature? _____ °F

Relative humidity? _____ Other? _____

Any additional information. (If special modifications have been made by the user, please describe.)

Be sure to include your name and phone number on this service form.

Specifications are subject to change without notice.

All Keithley trademarks and trade names are the property of Keithley Instruments, Inc. All other trademarks and trade names are the property of their respective companies.

KEITHLEY

Keithley Instruments, Inc.

28775 Aurora Road • Cleveland, Ohio 44139 • 440-248-0400 • Fax: 440-248-6168
1-888-KEITHLEY (534-8453) • www.keithley.com

Sales Offices:	BELGIUM:	Bergensesteenweg 709 • B-1600 Sint-Pieters-Leeuw • 02-363 00 40 • Fax: 02/363 00 64
	CHINA:	Yuan Chen Xin Building, Room 705 • 12 Yumin Road, Dewai, Madian • Beijing 100029 • 8610-8225-1886 • Fax: 8610-8225-1892
	FINLAND:	Tietäjäsentie 2 • 02130 Espoo • Phone: 09-54 75 08 10 • Fax: 09-25 10 51 00
	FRANCE:	3, allée des Garays • 91127 Palaiseau Cédex • 01-64 53 20 20 • Fax: 01-60 11 77 26
	GERMANY:	Landsberger Strasse 65 • 82110 Germering • 089/84 93 07-40 • Fax: 089/84 93 07-34
	GREAT BRITAIN:	Unit 2 Commerce Park, Brunel Road • Theale • Berkshire RG7 4AB • 0118 929 7500 • Fax: 0118 929 7519
	INDIA:	1/5 Eagles Street • Langford Town • Bangalore 560 025 • 080 212 8027 • Fax: 080 212 8005
	ITALY:	Viale San Gimignano, 38 • 20146 Milano • 02-48 39 16 01 • Fax: 02-48 30 22 74
	JAPAN:	New Pier Takeshiba North Tower 13F • 11-1, Kaigan 1-chome • Minato-ku, Tokyo 105-0022 • 81-3-5733-7555 • Fax: 81-3-5733-7556
	KOREA:	2FL., URI Building • 2-14 Yangjae-Dong • Seocho-Gu, Seoul 137-888 • 82-2-574-7778 • Fax: 82-2-574-7838
	NETHERLANDS:	Postbus 559 • 4200 AN Gorinchem • 0183-635333 • Fax: 0183-630821
	SWEDEN:	c/o Regus Business Centre • Frosundaviks Allé 15, 4tr • 169 70 Solna • 08-509 04 600 • Fax: 08-655 26 10
	TAIWAN:	13F-3, No. 6, Lane 99, Pu-Ding Road • Hsinchu, Taiwan, R.O.C. • 886-3-572-9077 • Fax: 886-3-572-9031